



STPS30H60C

Power Schottky rectifier

Main product characteristics

$I_{F(AV)}$	2 X 15 A
V_{RRM}	60 V
T_j	175° C
V_F (typ)	0.535 V

Features and benefits

- High junction temperature capability
- Avalanche rated
- Low leakage current
- Good trade-off between leakage current and forward voltage drop
- High frequency operation

Description

Dual centre tab Schottky rectifier suited for high frequency switch mode power supply.

Packaged in TO-220FPAB, TO-220AB, TO-247, I²PAK, and D²PAK, this device is intended to be used in notebook and LCD adaptors and desktop SMPS. In these applications the STPS30H60C provides a good margin between the remaining voltages applied on the diode and the voltage capability of the diode

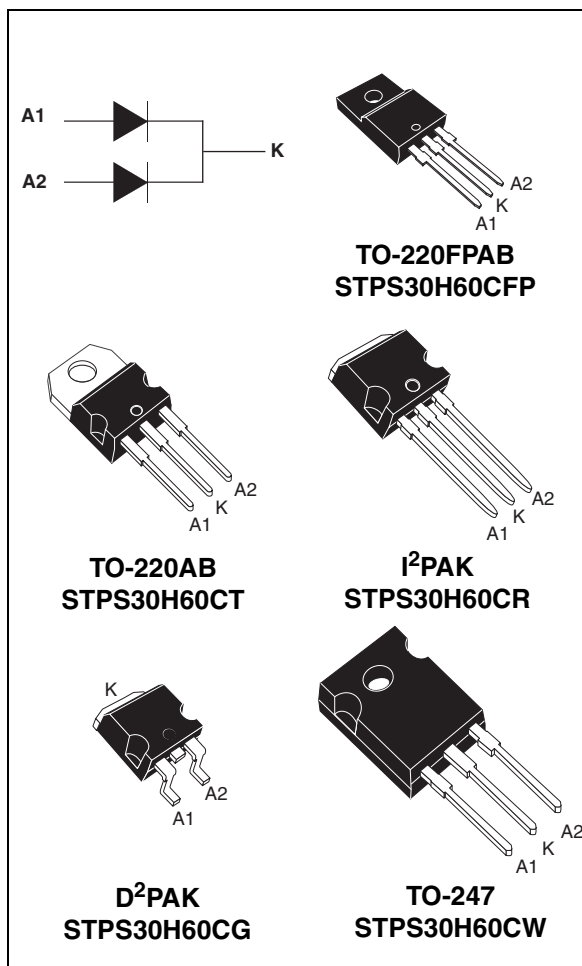

Order codes

Part Number	Marking
STPS30H60CT	STPS30H60CT
STPS30H60CR	STPS30H60CR
STPS30H60CG-TR	STPS30H60CG
STPS30H60CG	STPS30H60CG
STPS30H60CW	STPS30H60CW
STPS30H60CFP	STPS30H60CFP

1 Characteristics

Table 1. Absolute ratings (limiting values per diode)

Symbol	Parameter		Value	Unit	
V_{RRM}	Repetitive peak reverse voltage		60	V	
$I_{F(RMS)}$	RMS forward current		30	A	
$I_{F(AV)}$	Average forward current, $\delta = 0.5$	TO-220AB $T_c = 155^\circ\text{C}$	Per diode	15	A
			Total package	30	
		TO-220FPAB $T_c = 135^\circ\text{C}$	Per diode	15	
			Total package	30	
I_{FSM}	Surge non repetitive forward current	$t_p = 10\text{ ms Sinusoidal}$	230	A	
P_{ARM}	Releative peak avalanche power	$T_j = 25^\circ\text{C}$	$t_p = 1\ \mu\text{s}$	10 200	W
T_{stg}	Storage temperature range		-65 to + 175	$^\circ\text{C}$	
T_j	Maximum operating junction temperature ⁽¹⁾		175	$^\circ\text{C}$	

1. $\frac{dP_{tot}}{dT_j} < \frac{1}{R_{th(j-a)}}$ condition to avoid thermal runaway for a diode on its own heatsink

Table 2. Thermal parameters

Symbol	Parameter		Value	Unit	
$R_{th(j-c)}$	Junction to case	TO-220AB, I ² PAK, D ² PAK, TO-247	Per diode	1.5	$^\circ\text{C/W}$
			Total	0.8	
		TO-220FPAB	Per diode	4.7	
			Total	3.95	
$R_{th(c)}$	Coupling	TO-220AB, I ² PAK, D ² PAK, TO-247	0.1		
		TO-220FPAB	3.2		

Table 3. Static electrical characteristics

Symbol	Parameter	Test conditions		Min.	Typ	Max.	Unit
$I_R^{(1)}$	Reverse leakage current	$T_j = 25^\circ\text{C}$	$V_R = V_{RRM}$			60	μA
		$T_j = 125^\circ\text{C}$			8	25	mA
$V_F^{(2)}$	Forward voltage drop	$T_j = 25^\circ\text{C}$	$I_F = 7.5\text{ A}$			550	mV
		$T_j = 125^\circ\text{C}$			435	470	
		$T_j = 25^\circ\text{C}$	$I_F = 15\text{ A}$			660	
		$T_j = 125^\circ\text{C}$			535	570	
		$T_j = 25^\circ\text{C}$	$I_F = 30\text{ A}$			820	
		$T_j = 125^\circ\text{C}$			635	690	

1. Pulse test: $t_p = 5\text{ ms}$, $\delta < 2\%$
 2. Pulse test: $t_p = 380\ \mu\text{s}$, $\delta < 2\%$

To evaluate the conduction losses use the following equation:

$$P = 0.45 \times I_{F(AV)} + 0.008 \times I_{F(RMS)}^2$$

Figure 1. Conduction losses versus average forward current

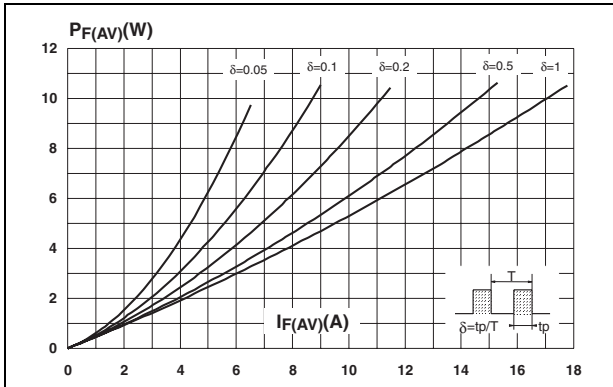

Figure 2. Average forward current versus ambient temperature (delta = 0.5, per diode)

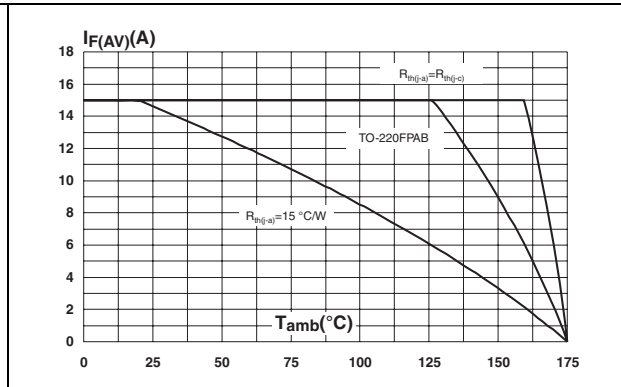

Figure 3. Normalized avalanche power derating versus pulse duration

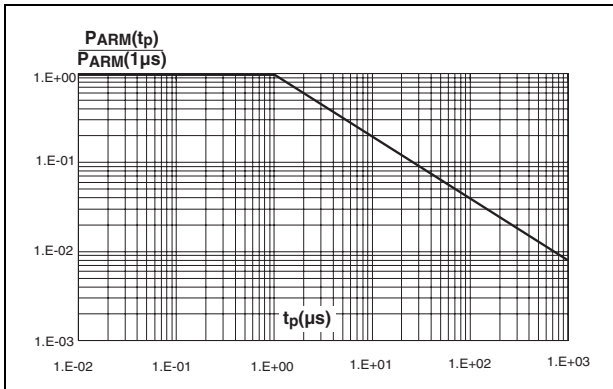

Figure 4. Normalized avalanche power derating versus junction temperature

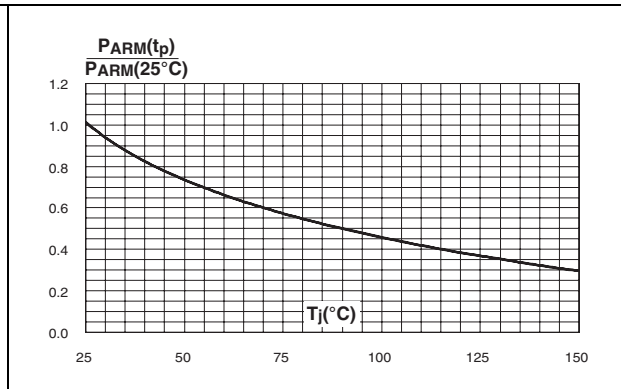

Figure 5. Non repetitive surge peak forward current versus overload duration (maximum values, per diode) (TO-220AB, TO-247 D²PAK, I²PAK)

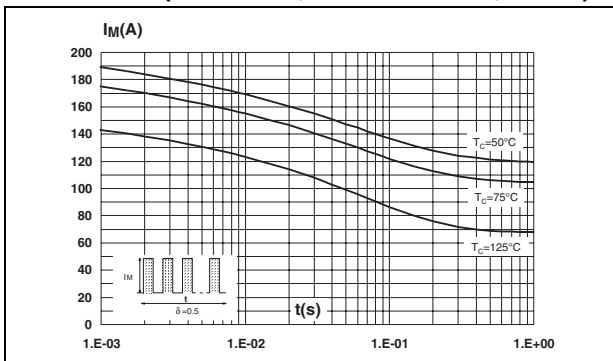

Figure 6. Non repetitive surge peak forward current versus overload duration (maximum values, per diode) (TO-220FPAB)

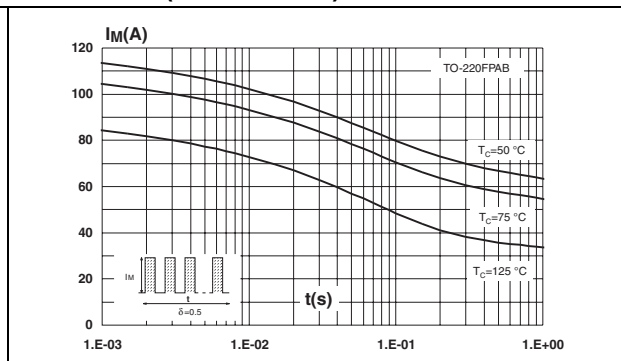

Figure 7. Relative variation of thermal impedance junction to case versus pulse duration (TO-220AB, TO-247 D²PAK, I²PAK)

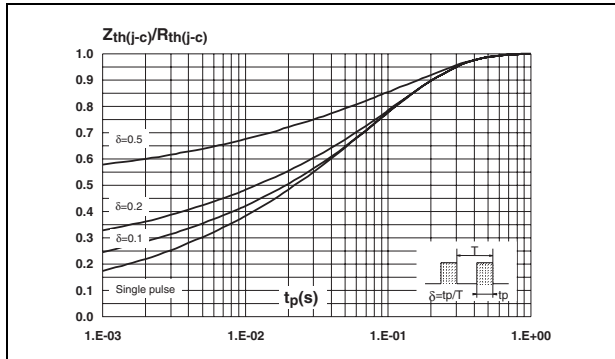

Figure 8. Relative variation of thermal impedance junction to case versus pulse duration (TO-220FPAB)

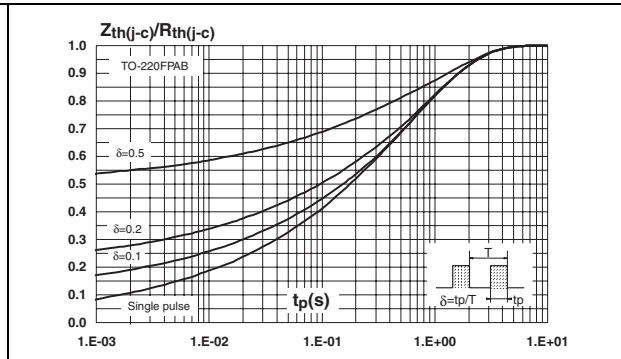

Figure 9. Reverse leakage current versus reverse voltage applied (typical values, per diode)

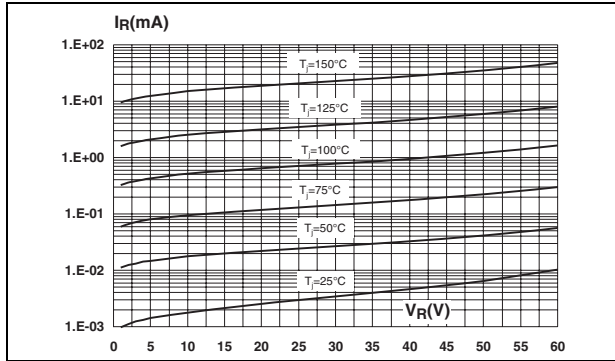

Figure 10. Junction capacitance versus reverse voltage applied (typical values, per diode)

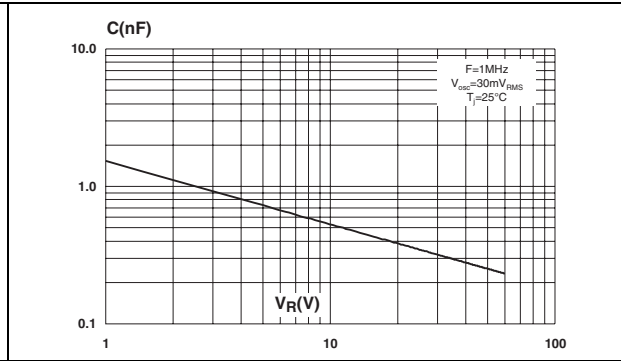

Figure 11. Forward voltage drop versus forward current (per diode)

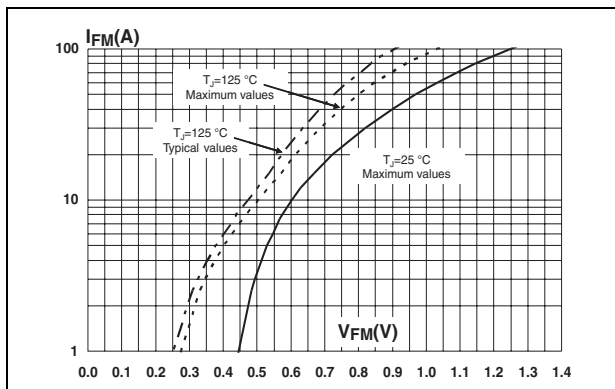
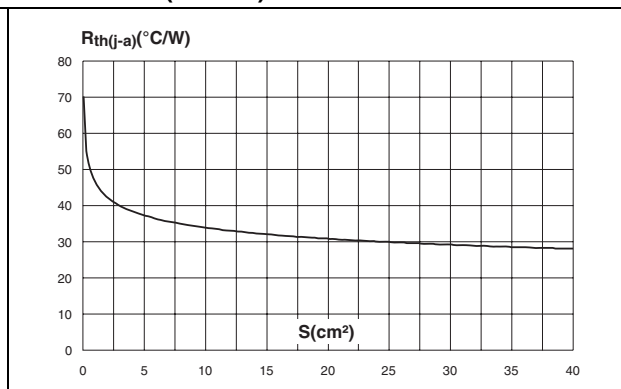

Figure 12. Thermal resistance junction to ambient versus copper surface under tab (epoxy printed board FR4, copper thickness = 35 μm) (D²PAK)



2 Package mechanical data

- Epoxy meets UL94, V0
- Cooling method: by conduction (C)
- Recommended torque value: 0.8 Nm
- Maximum torque value: 1.0 Nm

Table 4. TO-220FPAB dimensions

Ref.	Dimensions			
	Millimeters		Inches	
	Min.	Max.	Min.	Max.
A	4.4	4.6	0.173	0.181
B	2.5	2.7	0.098	0.106
D	2.5	2.75	0.098	0.108
E	0.45	0.70	0.018	0.027
F	0.75	1	0.030	0.039
F1	1.15	1.70	0.045	0.067
F2	1.15	1.70	0.045	0.067
G	4.95	5.20	0.195	0.205
G1	2.4	2.7	0.094	0.106
H	10	10.4	0.393	0.409
L2	16 Typ.		0.63 Typ.	
L3	28.6	30.6	1.126	1.205
L4	9.8	10.6	0.386	0.417
L5	2.9	3.6	0.114	0.142
L6	15.9	16.4	0.626	0.646
L7	9.00	9.30	0.354	0.366
Dia.	3.00	3.20	0.118	0.126

Table 5. TO-220AB dimensions

Ref	Dimensions			
	Millimeters		Inches	
	Min.	Max.	Min.	Max.
A	4.40	4.60	0.173	0.181
C	1.23	1.32	0.048	0.051
D	2.40	2.72	0.094	0.107
E	0.49	0.70	0.019	0.027
F	0.61	0.88	0.024	0.034
F1	1.14	1.70	0.044	0.066
F2	1.14	1.70	0.044	0.066
G	4.95	5.15	0.194	0.202
G1	2.40	2.70	0.094	0.106
H2	10	10.40	0.393	0.409
L2	16.4 typ.		0.645 typ.	
L4	13	14	0.511	0.551
L5	2.65	2.95	0.104	0.116
L6	15.25	15.75	0.600	0.620
L7	6.20	6.60	0.244	0.259
L9	3.50	3.93	0.137	0.154
M	2.6 typ.		0.102 typ.	
Diam.	3.75	3.85	0.147	0.151

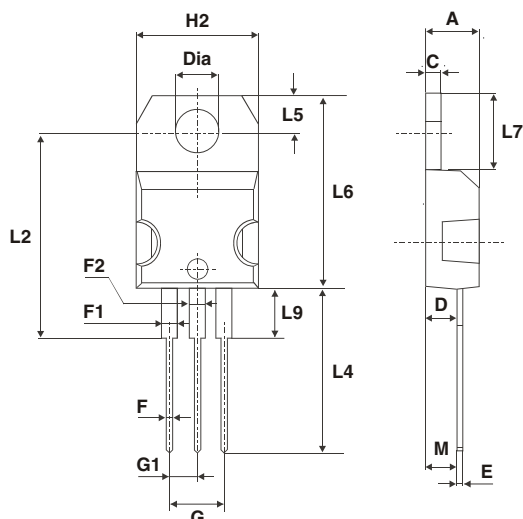

Table 6. TO-247 dimensions

REF	DIMENSIONS					
	Millimeters			Inches		
	Min.	Typ.	Max.	Min.	Typ.	Max.
A	4.85		5.15	0.191		0.203
D	2.20		2.60	0.086		0.102
E	0.40		0.80	0.015		0.031
F	1.00		1.40	0.039		0.055
F1		3.00			0.118	
F2		2.00			0.078	
F3	2.00		2.40	0.078		0.094
F4	3.00		3.40	0.118		0.133
G		10.90			0.429	
H	15.45		15.75	0.608		0.620
L	19.85		20.15	0.781		0.793
L1	3.70		4.30	0.145		0.169
L2		18.50			0.728	
L3	14.20		14.80	0.559		0.582
L4		34.60			1.362	
L5		5.50			0.216	
M	2.00		3.00	0.078		0.118
V		5°			5°	
V2		60°			60°	
Dia.	3.55		3.65	0.139		0.143

Table 7. I²PAK dimensions

REF.	DIMENSIONS			
	Millimeters		Inches	
	Min.	Max.	Min.	Max.
A	4.40	4.60	0.173	0.181
A1	2.40	2.72	0.094	0.107
b	0.61	0.88	0.024	0.035
b1	1.14	1.70	0.044	0.067
c	0.49	0.70	0.019	0.028
c2	1.23	1.32	0.048	0.052
D	8.95	9.35	0.352	0.368
e	2.40	2.70	0.094	0.106
e1	4.95	5.15	0.195	0.203
E	10	10.40	0.394	0.409
L	13	14	0.512	0.551
L1	3.50	3.93	0.138	0.155
L2	1.27	1.40	0.050	0.055

Table 8. D²PAK dimensions

REF.	DIMENSIONS			
	Millimeters		Inches	
	Min.	Max	Min.	Max.
A	4.40	4.60	0.173	0.181
A1	2.49	2.69	0.098	0.106
A2	0.03	0.23	0.001	0.009
B	0.70	0.93	0.027	0.037
B2	1.14	1.70	0.045	0.067
C	0.45	0.60	0.017	0.024
C2	1.23	1.36	0.048	0.054
D	8.95	9.35	0.352	0.368
E	10.00	10.40	0.393	0.409
G	4.88	5.28	0.192	0.208
L	15.00	15.85	0.590	0.624
L2	1.27	1.40	0.050	0.055
L3	1.40	1.75	0.055	0.069
M	2.40	3.20	0.094	0.126
R	0.40 typ.		0.016 typ.	
V2	0°	8°	0°	8°

Figure 13. Footprint (dimensions in millimeters)

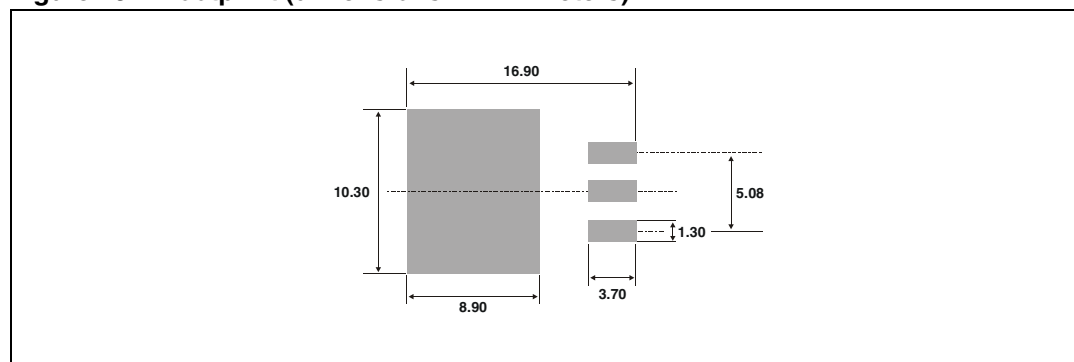

In order to meet environmental requirements, ST offers these devices in ECOPACK® packages. These packages have a Lead-free second level interconnect . The category of second level interconnect is marked on the package and on the inner box label, in compliance with JEDEC Standard JESD97. The maximum ratings related to soldering conditions are also marked on the inner box label. ECOPACK is an ST trademark. ECOPACK specifications are available at: www.st.com.

3 Ordering information

Part Number	Marking	Package	Weight	Base qty	Delivery mode
STPS30H60CT	STPS30H60CT	TO-220AB	2.23 g	50	Tube
STPS30H60CR	STPS30H60CR	I ² PAK	1.49 g	50	Tube
STPS30H60CG	STPS30H60CG	D ² PAK	1.48 g	50	Tube
STPS30H60CG-TR	STPS30H60CG-TR	D ² PAK	1.48 g	1000	Tape & reel
STPS30H60CW	STPS30H60W	TO-247	4.46 g	30	Tube
STPS30H60CFP	STPS30H60CFP	TO-220FPAB	2.00 g	50	Tube

4 Revision history

Date	Revision	Description of Changes
27-Feb-2006	1	First issue
31-Mar-2007	2	Added TO-220FPAB package. Updated thermal parameters in Table 2.

STPS30H60C

Please Read Carefully:

Information in this document is provided solely in connection with ST products. STMicroelectronics NV and its subsidiaries ("ST") reserve the right to make changes, corrections, modifications or improvements, to this document, and the products and services described herein at any time, without notice.

All ST products are sold pursuant to ST's terms and conditions of sale.

Purchasers are solely responsible for the choice, selection and use of the ST products and services described herein, and ST assumes no liability whatsoever relating to the choice, selection or use of the ST products and services described herein.

No license, express or implied, by estoppel or otherwise, to any intellectual property rights is granted under this document. If any part of this document refers to any third party products or services it shall not be deemed a license grant by ST for the use of such third party products or services, or any intellectual property contained therein or considered as a warranty covering the use in any manner whatsoever of such third party products or services or any intellectual property contained therein.

UNLESS OTHERWISE SET FORTH IN ST'S TERMS AND CONDITIONS OF SALE ST DISCLAIMS ANY EXPRESS OR IMPLIED WARRANTY WITH RESPECT TO THE USE AND/OR SALE OF ST PRODUCTS INCLUDING WITHOUT LIMITATION IMPLIED WARRANTIES OF MERCHANTABILITY, FITNESS FOR A PARTICULAR PURPOSE (AND THEIR EQUIVALENTS UNDER THE LAWS OF ANY JURISDICTION), OR INFRINGEMENT OF ANY PATENT, COPYRIGHT OR OTHER INTELLECTUAL PROPERTY RIGHT.

UNLESS EXPRESSLY APPROVED IN WRITING BY AN AUTHORIZED ST REPRESENTATIVE, ST PRODUCTS ARE NOT RECOMMENDED, AUTHORIZED OR WARRANTED FOR USE IN MILITARY, AIR CRAFT, SPACE, LIFE SAVING, OR LIFE SUSTAINING APPLICATIONS, NOR IN PRODUCTS OR SYSTEMS WHERE FAILURE OR MALFUNCTION MAY RESULT IN PERSONAL INJURY, DEATH, OR SEVERE PROPERTY OR ENVIRONMENTAL DAMAGE. ST PRODUCTS WHICH ARE NOT SPECIFIED AS "AUTOMOTIVE GRADE" MAY ONLY BE USED IN AUTOMOTIVE APPLICATIONS AT USER'S OWN RISK.

Resale of ST products with provisions different from the statements and/or technical features set forth in this document shall immediately void any warranty granted by ST for the ST product or service described herein and shall not create or extend in any manner whatsoever, any liability of ST.

ST and the ST logo are trademarks or registered trademarks of ST in various countries.

Information in this document supersedes and replaces all information previously supplied.

The ST logo is a registered trademark of STMicroelectronics. All other names are the property of their respective owners.

© 2007 STMicroelectronics - All rights reserved

STMicroelectronics group of companies

Australia - Belgium - Brazil - Canada - China - Czech Republic - Finland - France - Germany - Hong Kong - India - Israel - Italy - Japan - Malaysia - Malta - Morocco - Singapore - Spain - Sweden - Switzerland - United Kingdom - United States of America

www.st.com

