

Cree® XLamp® XR-C LED

Data Sheet

The XLamp XR-C LED gives lighting designers the flexibility and performance to create the next generation of LED lighting products. XLamp XR-C LEDs feature electrically neutral thermal path, low thermal resistance and support for a wide range of drive currents.

Cree XLamp LEDs bring high performance and quality of light to a wide range of lighting applications, including color-changing lighting, portable and personal lighting, outdoor lighting, indoor directional lighting, commercial lighting and emergency-vehicle lighting.

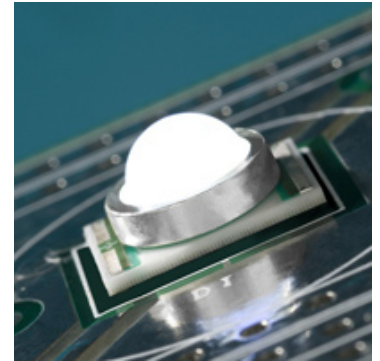

FEATURES

- Available in white (2,600 K to 10,000 K CCT), royal blue, blue, green, amber, red-orange & red
- Maximum drive current: up to 700 mA
- Low thermal resistance: as low as 12°C/W
- Max junction temperature: 150°C
- Industry-leading JEDEC standard pre-qualification testing
- Reflow solderable – JEDEC J-STD-020C compatible
- Electrically neutral thermal path
- RoHS-compliant
- Lumen maintenance of greater than 70% after 50,000 hours

Table of Contents

Flux Characteristics ($T_j = 25^\circ\text{C}$) - White	2
Flux Characteristics ($T_j = 25^\circ\text{C}$) - Color.....	2
Characteristics - White, Royal Blue, Blue, Green	4
Characteristics - Amber, Red-Orange, Red.....	4
Relative Spectral Power Distribution	5
Relative Flux vs. Junction Temperature ($I_f = 350\text{ mA}$).....	6
Electrical Characteristics ($T_j = 25^\circ\text{C}$).....	7
Thermal Design.....	8
Relative Flux vs. Current ($T_j = 25^\circ\text{C}$)	9
Typical Spatial Distribution.....	10
Reflow Soldering Characteristics	11
Notes.....	12
Mechanical Dimensions ($T_A = 25^\circ\text{C}$)	13
Tape and Reel	14
Dry Packaging and Packaging	15



Flux Characteristics ($T_j = 25^\circ\text{C}$) - White

The following tables describe the available colors and flux for XR-C LEDs by listing the correlated color temperature range for the entire family and by providing several base order codes. It is important to note that the base order codes listed here are a subset of the total available order codes for the product family. For more order codes, as well as a complete description of the order-code nomenclature, please consult the XR-E & XR-C Binning and Labeling document.

Color	CCT Range		Base Order Codes Min Luminous Flux (lm)		Order Code
	Min.	Max.	Group	Flux (lm)	
Cool White	5,000 K	10,000 K	N3	56.8	XRCWHT-L1-0000-00501
			N4	62.0	XRCWHT-L1-0000-00601
			P2	67.2	XRCWHT-L1-0000-00701
			P3	73.9	XRCWHT-L1-0000-00801
			P4	80.6	XRCWHT-L1-0000-00901
			Q2	87.4	XRCWHT-L1-0000-00A01
Neutral White	3,700 K	5,000 K	N3	56.8	XRCWHT-L1-0000-005E4
			N4	62.0	XRCWHT-L1-0000-006E4
			P2	67.2	XRCWHT-L1-0000-007E4
			P3	73.9	XRCWHT-L1-0000-008E4
			P4	80.6	XRCWHT-L1-0000-009E4
Warm White	2,600 K	3,700 K	M3	45.7	XRCWHT-L1-0000-003E7
			N2	51.7	XRCWHT-L1-0000-004E7
			N3	56.8	XRCWHT-L1-0000-005E7
			N4	62.0	XRCWHT-L1-0000-006E7
			P2	67.2	XRCWHT-L1-0000-007E7

Notes:

- Cree maintains a tolerance of +/- 7% on flux and power measurements.
- Typical CRI for Cool White & Neutral White (3,700 K – 10,000 K CCT) is 75.
- Typical CRI for Warm White (2,600 K – 3,700 K CCT) is 80.

Flux Characteristics ($T_j = 25^\circ\text{C}$) - Color

Color	Dominant Wavelength Range				Base Order Codes Min Radiant Flux (mW)		Order Code
	Min.		Max.		Group	Flux (mW)	
	Group	DWL (nm)	Group	DWL (nm)			
Royal Blue	D3	450	D5	465	12	250	XRCROY-L1-0000-00701
					13	300	XRCROY-L1-0000-00801



Flux Characteristics ($T_j = 25^\circ\text{C}$) - Color continued

Color	Dominant Wavelength Range				Base Order Codes Min Luminous Flux (lm)		Order Code
	Min.		Max.		Group	Flux (lm)	
	Group	DWL (nm)	Group	DWL (nm)			
Blue	B3	465	B4	475	G	13.9	XRCBLU-L1-0000-00G01
					H	18.1	XRCBLU-L1-0000-00H01

Color	Dominant Wavelength Range				Base Order Codes Min Luminous Flux (lm)		Order Code
	Min.		Max.		Group	Flux (lm)	
	Group	DWL (nm)	Group	DWL (nm)			
Green	G2	520	G4	535	M	39.8	XRCGRN-L1-0000-00M01
					N	51.7	XRCGRN-L1-0000-00N01

Color	Dominant Wavelength Range				Base Order Codes Min Luminous Flux (lm)		Order Code
	Min.		Max.		Group	Flux (lm)	
	Group	DWL (nm)	Group	DWL (nm)			
Amber	A2	585	A3	595	J	23.5	XRCAMB-L1-0000-00J01
					K	30.6	XRCAMB-L1-0000-00K01
					M	39.8	XRCAMB-L1-0000-00M01

Color	Dominant Wavelength Range				Base Order Codes Min Luminous Flux (lm)		Order Code
	Min.		Max.		Group	Flux (lm)	
	Group	DWL (nm)	Group	DWL (nm)			
Red-Orange	O3	610	O4	620	K	30.6	XRCRDO-L1-0000-00K01
					M	39.8	XRCRDO-L1-0000-00M01

Color	Dominant Wavelength Range				Base Order Codes Min Luminous Flux (lm)		Order Code
	Min.		Max.		Group	Flux (lm)	
	Group	DWL (nm)	Group	DWL (nm)			
Red	R2	620	R3	630	J	23.5	XRCRED-L1-0000-00J01
					K	30.6	XRCRED-L1-0000-00K01
					M	39.8	XRCRED-L1-0000-00M01

Note: Cree maintains a tolerance of +/- 7% on flux and power measurements.



Characteristics - White, Royal Blue, Blue, Green

Characteristics	Unit	Minimum	Typical	Maximum
Thermal Resistance, junction to solder point	°C/W		12	
Viewing Angle (FWHM) - white	degrees		90	
Viewing angle (FWHM) - royal blue, blue, green	degrees		100	
Temperature coefficient of voltage	mV/°C		-4.0	
ESD Classification (HBM per Mil-Std-883D)			Class 2	
DC Forward Current	mA			500
Reverse Voltage	V			5
Forward Voltage (@ 350 mA) - white, royal blue, blue	V		3.5	4.0
Forward Voltage (@ 350 mA) - green	V		3.7	4.0
Forward Voltage (@ 500 mA) - white, royal blue, blue	V		3.6	
LED Junction Temperature*	°C			150

* Note: For lumen maintenance data, see the Cree XLamp LED Reliability document.

Characteristics - Amber, Red-Orange, Red

Characteristics	Unit	Minimum	Typical	Maximum
Thermal Resistance, junction to solder point	°C/W		15	
Viewing Angle (FWHM)	degrees		90	
Temperature coefficient of voltage - red-orange, red	mV/°C		-2.3	
Temperature coefficient of voltage - amber	mV/°C		-1.8	
ESD Classification (HBM per Mil-Std-883D)			Class 2	
DC Forward Current - red-orange, red	mA			700
DC Forward Current - amber	mA			350
Reverse Voltage	V			5
Forward Voltage (@ 350 mA)	V		2.2	2.5
Forward Voltage (@ 700 mA) - red-orange, red	V		2.4	
LED Junction Temperature*	°C			150

* Note: For lumen maintenance data, see the Cree XLamp LED Reliability document.

Relative Spectral Power Distribution

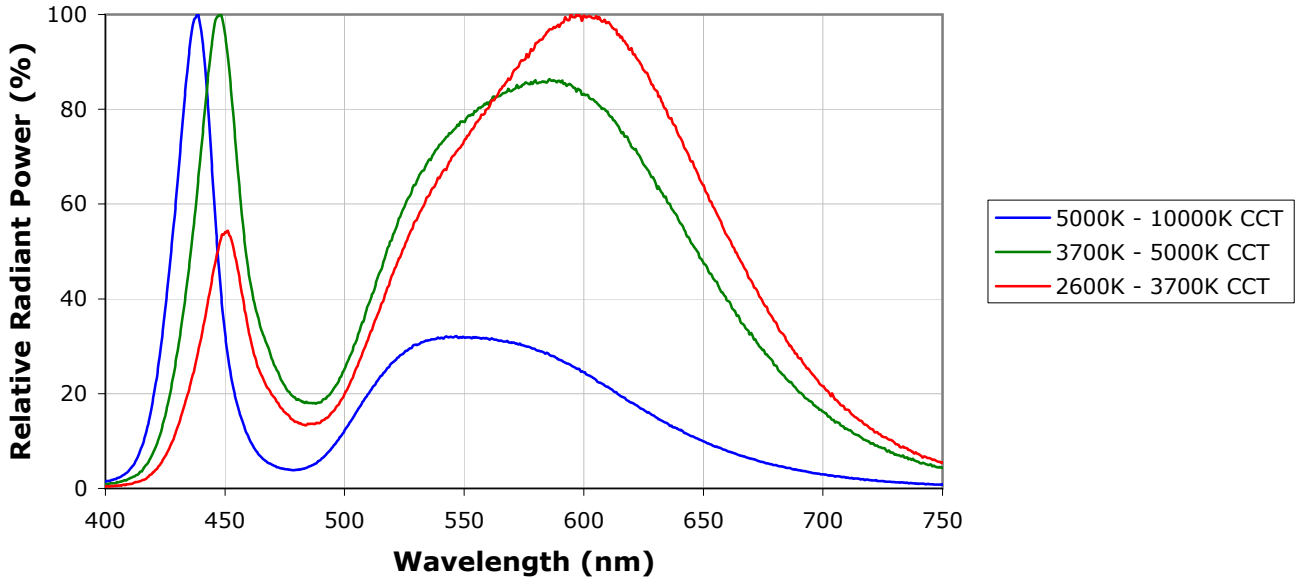

White

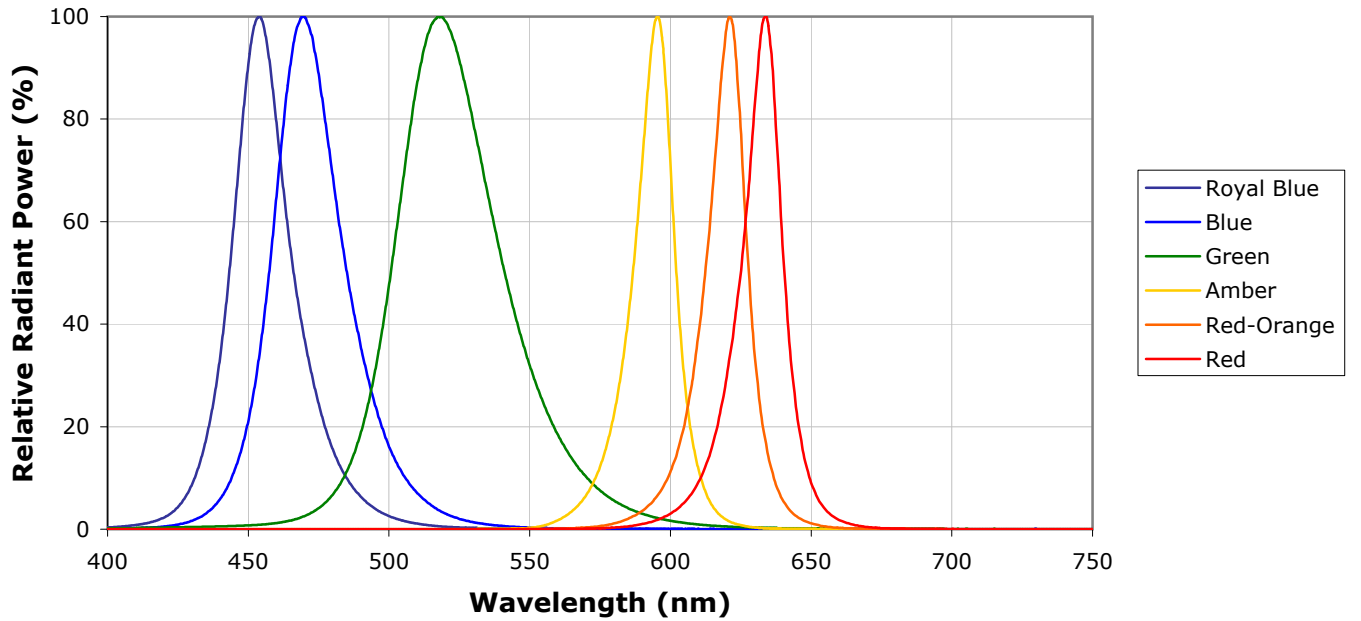

Color



Relative Flux vs. Junction Temperature ($I_F = 350\text{ mA}$)

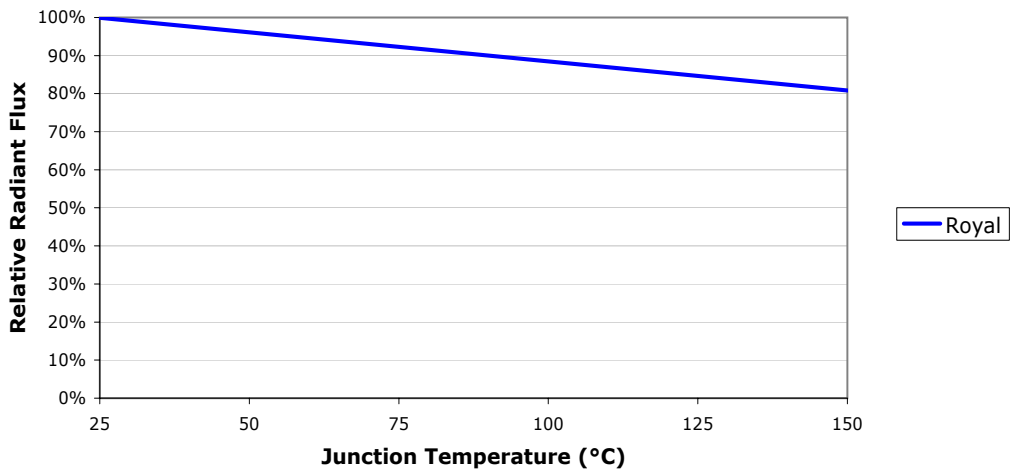
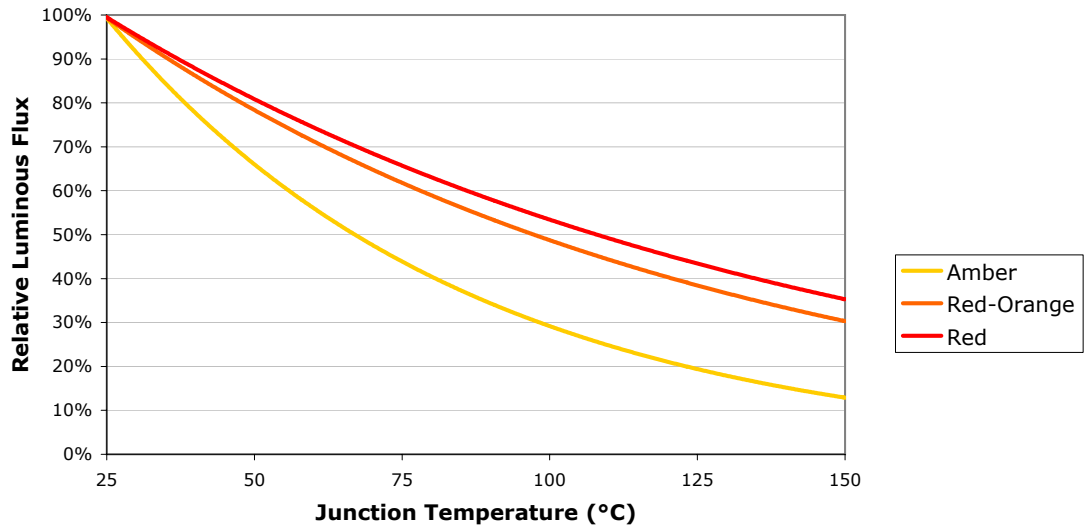
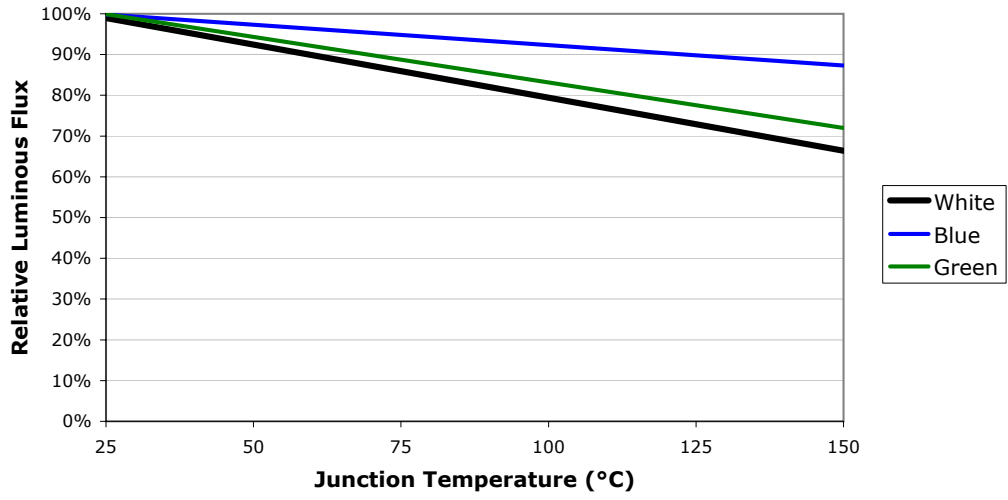

Electrical Characteristics ($T_j = 25^\circ\text{C}$)

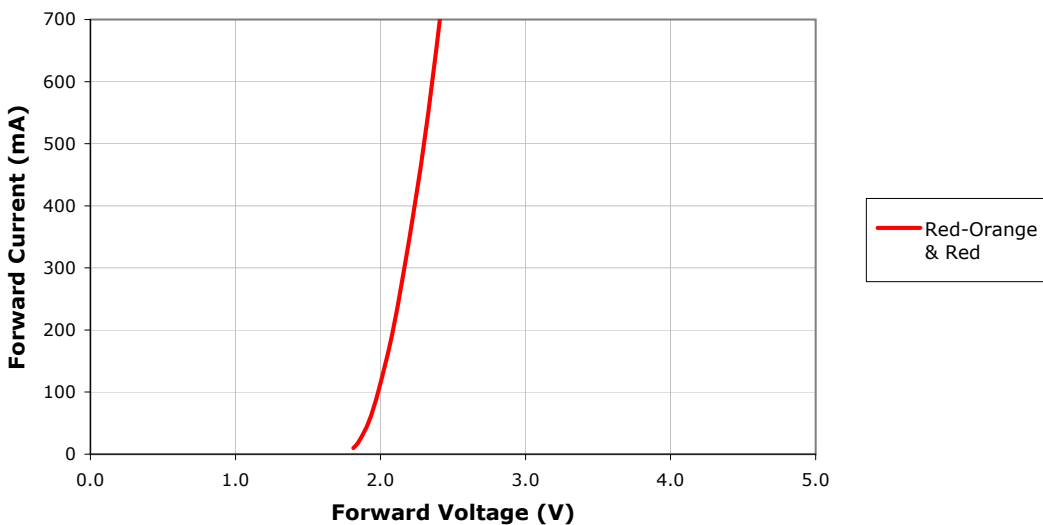
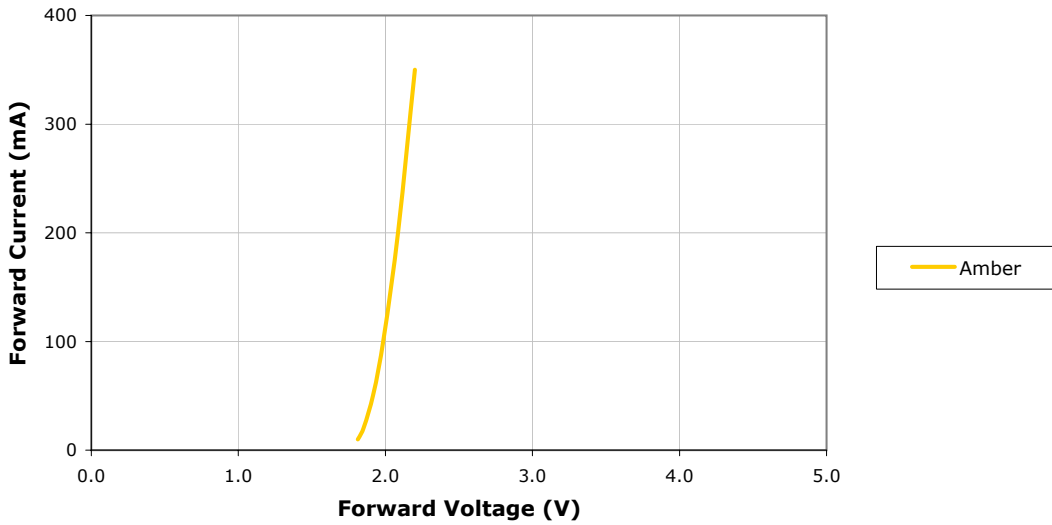
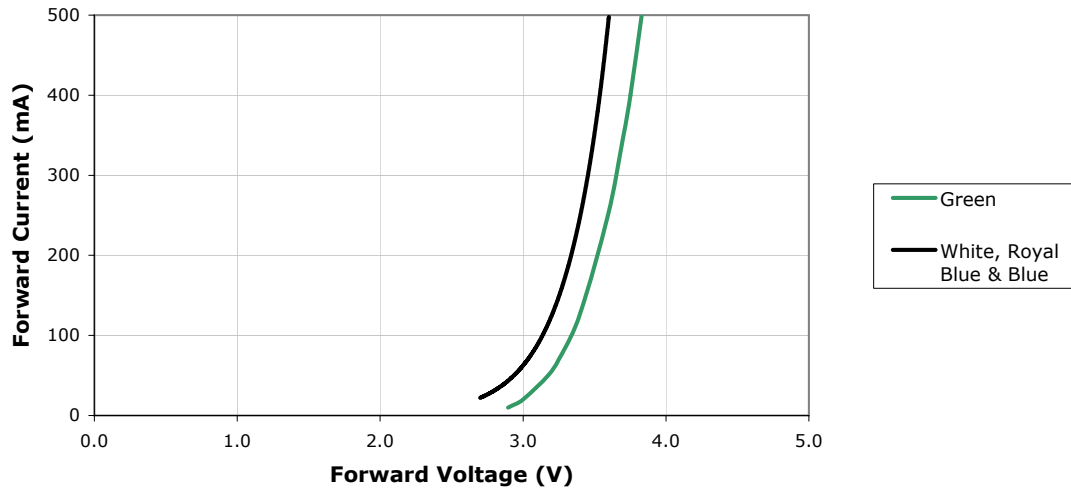

Thermal Design

The maximum forward current is determined by the thermal resistance between the LED junction and ambient. Given an existing thermal resistance of 12°C/W or 15°C/W between the junction and the solder point, it is crucial for the end product to be designed in a manner that minimizes the thermal resistance from the solder point to ambient in order to optimize lamp life and optical characteristics.

White
Royal Blue
Blue
Green

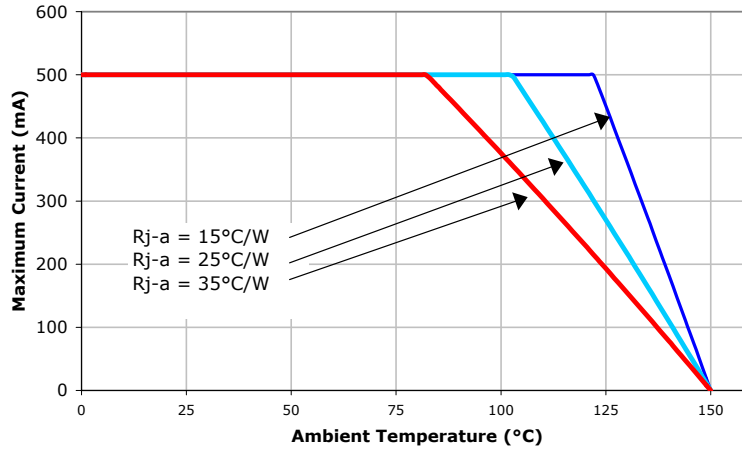

Amber

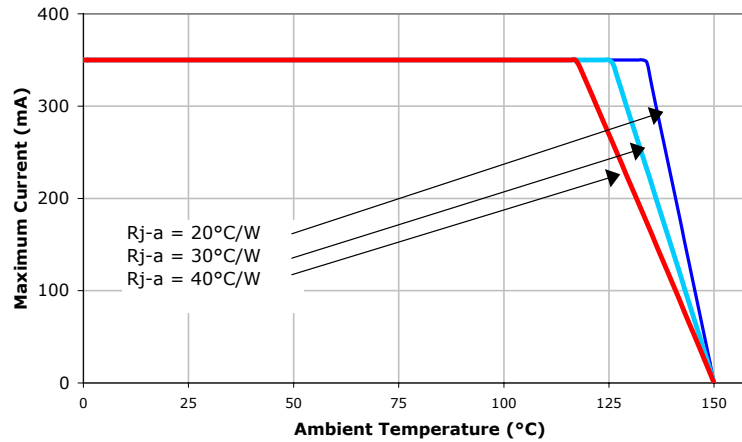

Red-Orange
Red

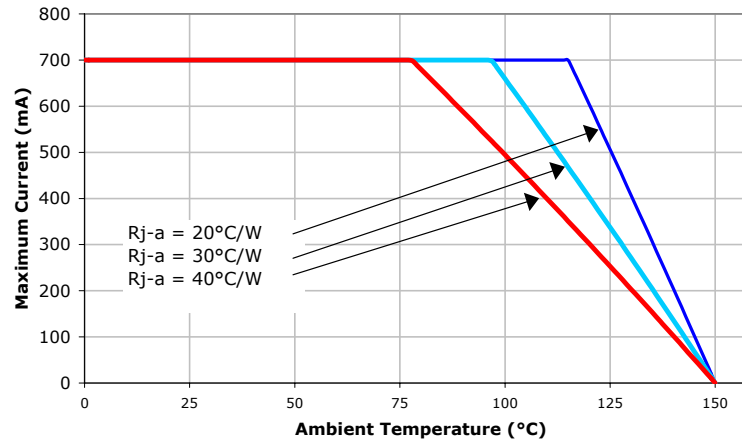

Relative Flux vs. Current ($T_j = 25^\circ\text{C}$)

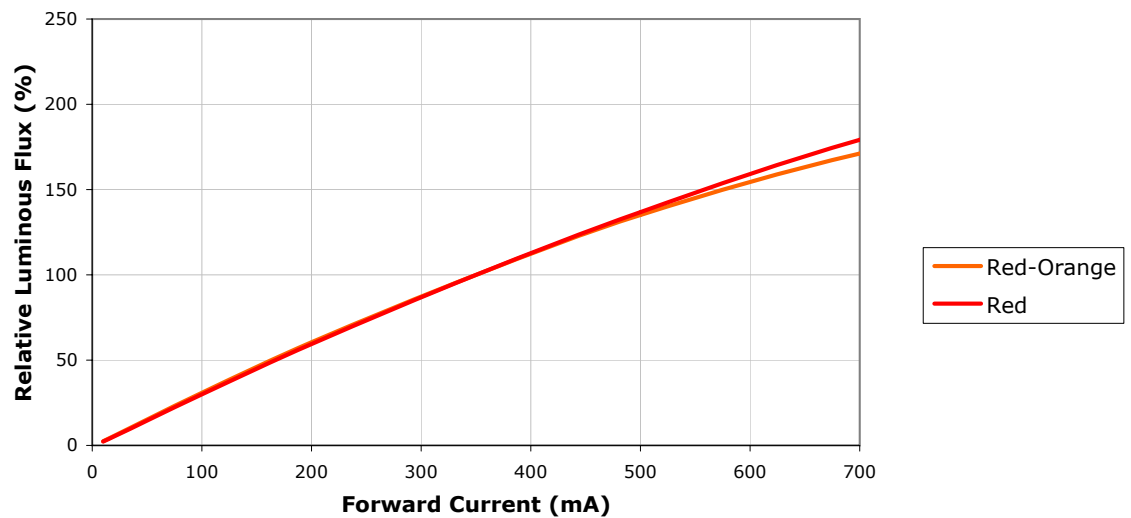
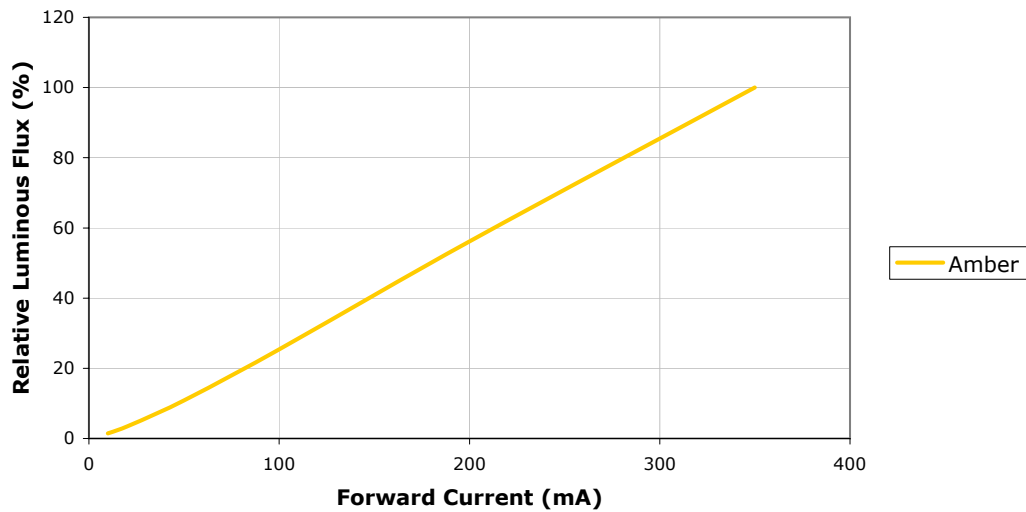
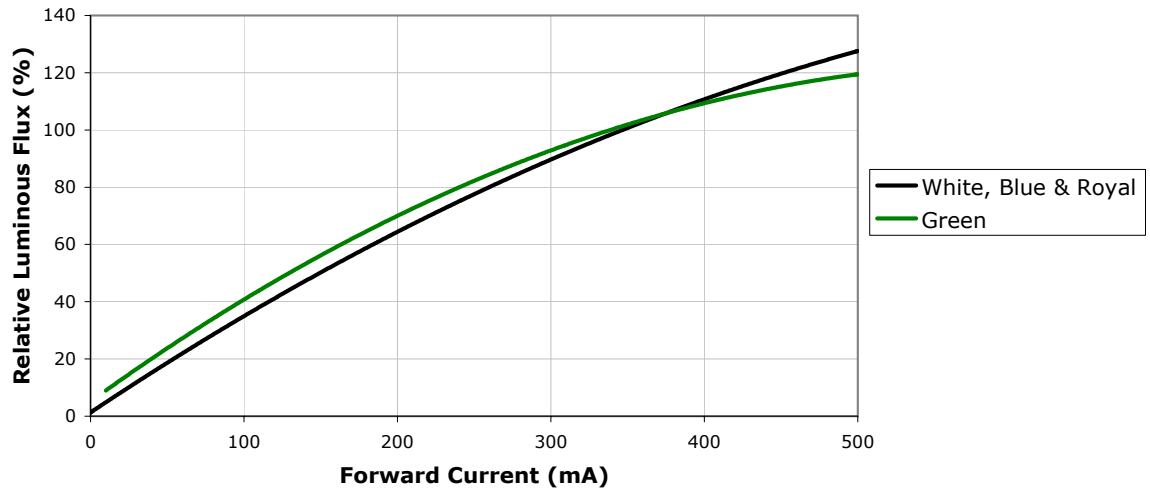

Typical Spatial Distribution

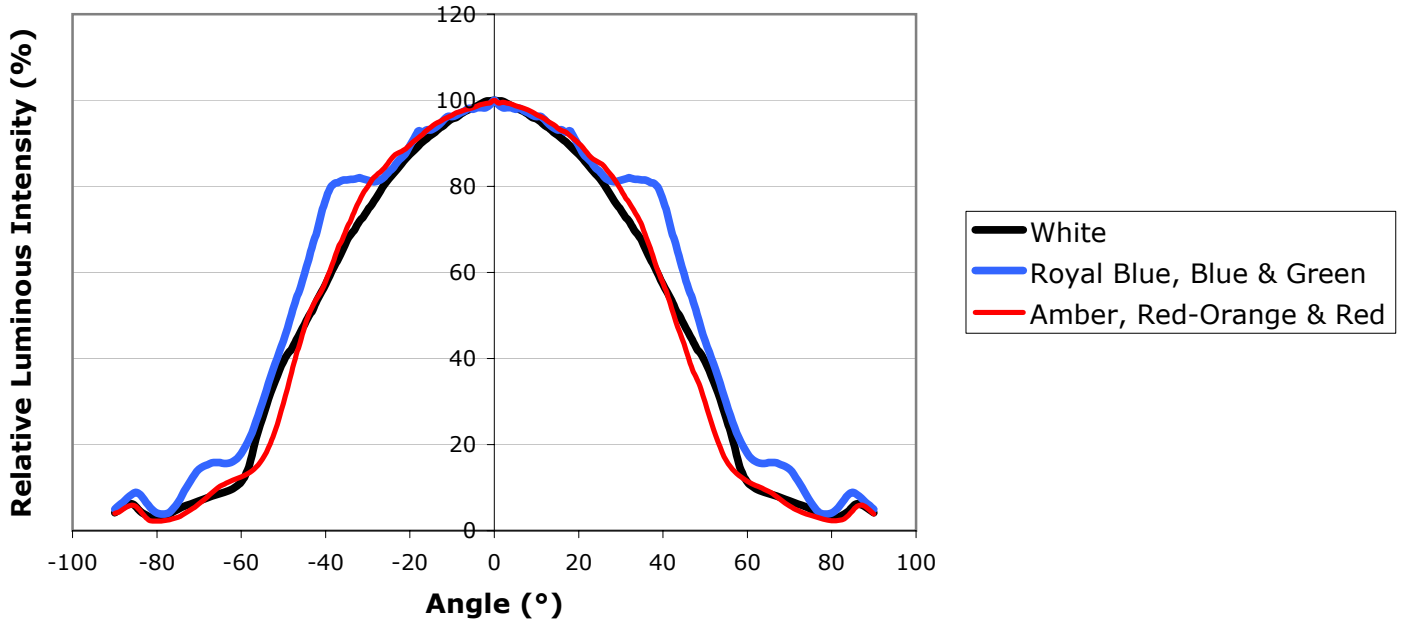

Reflow Soldering Characteristics

In testing, Cree has found XLamp XR-C LEDs to be compatible with JEDEC J-STD-020C, using the parameters listed below. As a general guideline, Cree recommends that users follow the recommended soldering profile provided by the manufacturer of solder paste used.

Note that this general guideline may not apply to all PCB designs and configurations of reflow soldering equipment.

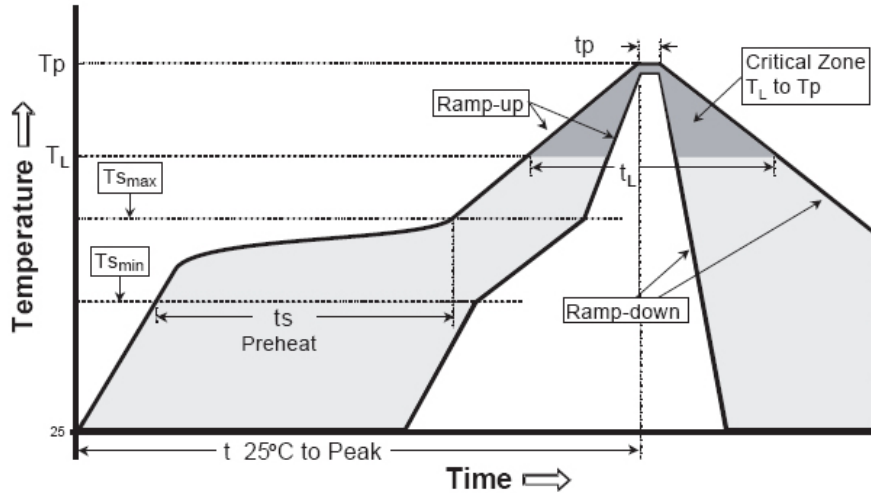

IPC/JEDEC J-STD-020C

Profile Feature	Lead-Based Solder	Lead-Free Solder
Average Ramp-Up Rate ($T_{s_{max}}$ to T_p)	3°C/second max.	3°C/second max.
Preheat: Temperature Min ($T_{s_{min}}$)	100°C	150°C
Preheat: Temperature Max ($T_{s_{max}}$)	150°C	200°C
Preheat: Time ($t_{s_{min}}$ to $t_{s_{max}}$)	60-120 seconds	60-180 seconds
Time Maintained Above: Temperature (T_l)	183°C	217°C
Time Maintained Above: Time (t_l)	60-150 seconds	60-150 seconds
Peak/Classification Temperature (T_p)	215°C	260°C
Time Within 5°C of Actual Peak Temperature (t_p)	10-30 seconds	20-40 seconds
Ramp-Down Rate	6°C/second max.	6°C/second max.
Time 25°C to Peak Temperature	6 minutes max.	8 minutes max.

Note: All temperatures refer to topside of the package, measured on the package body surface.



Notes

Lumen Maintenance Projections

Based on internal long-term reliability testing and standardized forecasting methods, Cree projects XLamp LEDs to maintain an average of 70% lumen maintenance after 50,000 hours, provided the LED junction temperature is maintained at or below 80°C.

Please read the XLamp Reliability application note for more details on Cree’s lumen maintenance testing and forecasting. Please read the XLamp Thermal Management application note for details on how thermal design, ambient temperature, and drive current affect the LED junction temperature.

Moisture Sensitivity

XLamp LEDs are shipped in sealed, moisture-barrier bags (MBB) designed for long shelf life. If XLamp LEDs are exposed to moist environments after opening the MBB packaging but before soldering, damage to the LED may occur during the soldering operation. The following derating table defines the maximum exposure time (in days) for an XLamp LED in the listed humidity and temperature conditions. LEDs with exposure time longer than the time specified below must be baked according to the baking conditions listed below.

Temperature	Maximum Percent Relative Humidity						
	30%	40%	50%	60%	70%	80%	90%
30°C	9	5	4	3	1	1	1
25°C	12	7	5	4	2	1	1
20°C	17	9	7	6	2	2	1

Baking Conditions

It is not necessary to bake all XLamp LEDs. Only the LEDs that meet all of the following criteria must be baked:

1. LEDs that have been removed from the original MBB packaging
2. LEDs that have been exposed to a humid environment longer than listed in the Moisture Sensitivity section above
3. LEDs that have not been soldered

LEDs should be baked at 80°C for 24 hours. LEDs may be baked on the original reels. Remove LEDs from MBB packaging before baking. Do not bake parts at temperatures higher than 80°C. This baking operation resets the exposure time as defined in the Moisture Sensitivity section above.

Storage Conditions

XLamp LEDs that have been removed from original MBB packaging but not soldered yet should be stored in a room or cabinet that will maintain an atmosphere of 25 ± 5°C and no greater than 10% RH (relative humidity). For LEDs stored in these conditions, storage time does not add to exposure time as defined in the Moisture Sensitivity section above.

RoHS Compliance

The levels of environmentally sensitive, persistent biologically toxic (PBT), persistent organic pollutants (POP), or otherwise restricted materials in this product are below the maximum concentration values (also referred to as the threshold limits) permitted for such substances, or are used in an exempted application, in accordance with EU Directive 2002/95/EC on the restriction of the use of certain hazardous substances in electrical and electronic equipment (RoHS), as amended through April 21, 2006.

Vision Advisory Claim

Users should be cautioned not to stare at the light of this LED product. The bright light can damage the eye.

Mechanical Dimensions (T_A = 25°C)

All measurements are ±.1mm unless otherwise indicated.

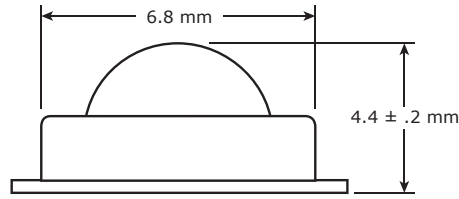
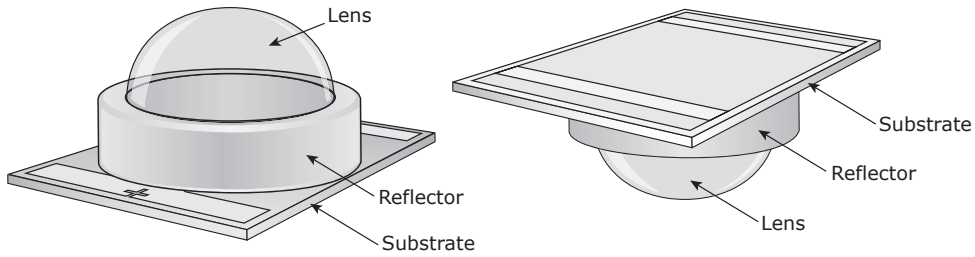

Side View

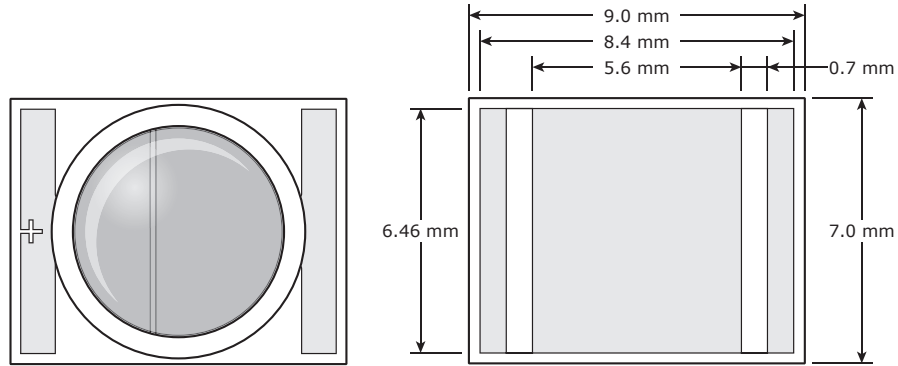

Top View

Bottom View

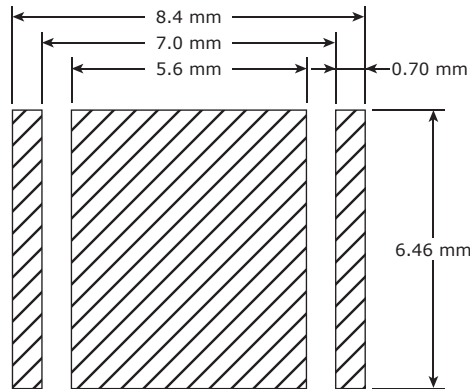

Recommended PC Board Solder Pad

Tape and Reel

All dimensions in mm.

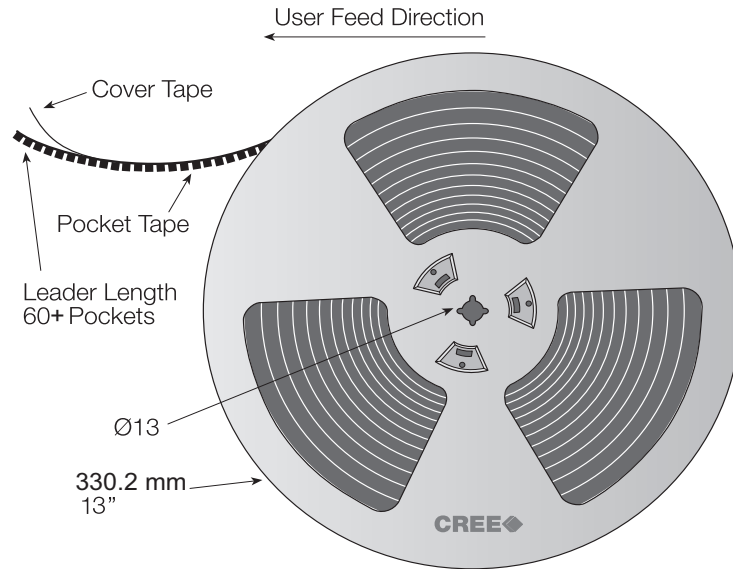
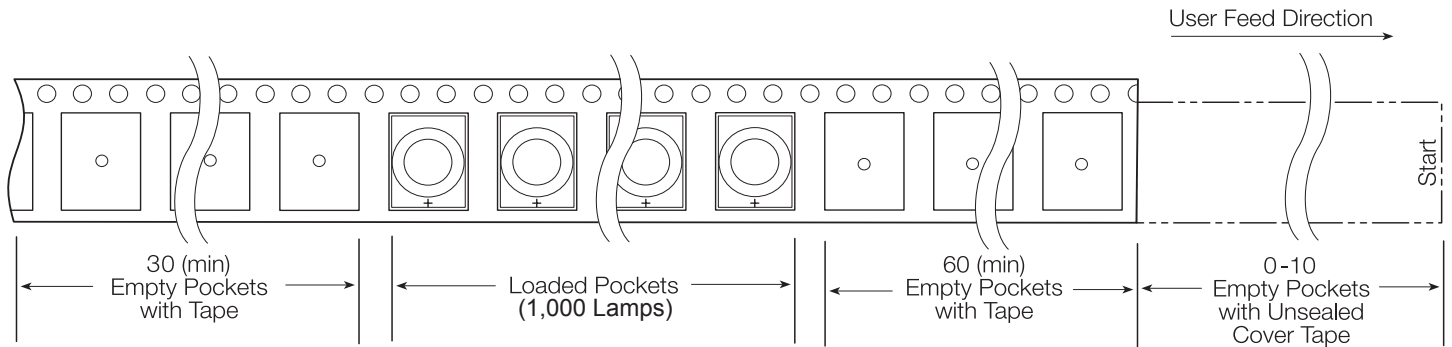
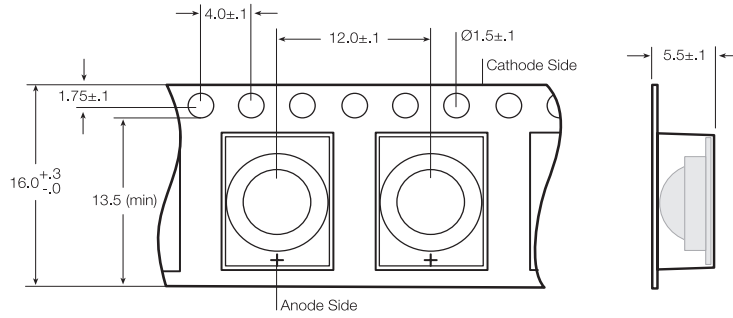

Dry Packaging and Packaging

