

## Introduction

The STM32F107VCT evaluation board STM3210C-EVAL is designed as a complete development platform for STMicroelectronics' ARM Cortex-M3 core-based STM32F107VCT microcontroller with full speed USB-OTG, ethernet MAC, two channels of CAN2.0A/B compliant interface, 2 channels I2S, 2 channels I2C, 5 channels USART with smartcard support, 3 channels SPI, internal 64 KB SRAM and 256 KB Flash, JTAG and SWD debugging support.

The full range of hardware features on the board help you evaluate all peripherals (USB-OTG FS, ethernet, motor control, CAN, microSD card™, smartcard, USART, audio DAC, MEMS, EEPROM... etc.) and develop your own applications. Extension headers make it easy to connect a daughterboard or wrapping board for your specific application.

**Figure 1. STM3210C-EVAL evaluation board**



# Contents

- 1 Overview ..... 4**
  - 1.1 Features ..... 4
  
- 2 Hardware layout and configuration ..... 5**
  - 2.1 Power supply ..... 7
  - 2.2 Boot option ..... 9
  - 2.3 Clock source ..... 9
  - 2.4 Reset source ..... 9
  - 2.5 Audio ..... 10
  - 2.6 EEPROM ..... 10
  - 2.7 CAN ..... 10
  - 2.8 RS-232 and IrDA ..... 11
  - 2.9 Motor control ..... 12
  - 2.10 Smartcard ..... 13
  - 2.11 MicroSD card ..... 14
  - 2.12 Analog input ..... 14
  - 2.13 Ethernet ..... 15
  - 2.14 USB-OTG ..... 15
  - 2.15 MEMS ..... 16
  - 2.16 Development and debug support ..... 16
  - 2.17 Display and input devices ..... 17
  - 2.18 IDD measurement ..... 18
  
- 3 Connectors ..... 20**
  - 3.1 Motor control connector CN17 ..... 20
  - 3.2 Analog input connector CN10 and CN11 ..... 21
  - 3.3 CAN D-type 9-pin male connector CN3 and CN4 ..... 21
  - 3.4 Ethernet RJ45 connector CN1 ..... 22
  - 3.5 Trace debugging connector CN12 ..... 22
  - 3.6 RS-232 connector CN6 ..... 23
  - 3.7 JTAG debugging connector CN13 ..... 23

3.8	Daughterboard extension connector CN8 and CN9 .....	24
3.9	Audio jack CN7 .....	27
3.10	TFT LCD connector CN14 .....	27
3.11	MicroSD card connector CN16 .....	28
3.12	USB MicroAB connector CN2 .....	28
3.13	Power connector CN18 .....	29
3.14	Smartcard connector CN5 .....	29
<b>4</b>	<b>Schematics .....</b>	<b>30</b>
4.1	STM3210C .....	30
4.2	MCU .....	31
4.3	Ethernet .....	32
4.4	Full speed USB-OTG .....	33
4.5	Audio .....	34
4.6	LCD .....	35
4.7	I/O expander .....	36
4.8	CAN .....	37
4.9	RS-232 and IrDA .....	38
4.10	Smartcard .....	39
4.11	Motor control .....	40
4.12	I/O peripherals .....	41
4.13	Extension connector .....	42
4.14	JTAG and trace .....	43
4.15	MicroSD card .....	44
4.16	Power .....	45
4.17	3.2" LCD module with SPI and 16-bit interface .....	46
	<b>Appendix A STM3210C-EVAL I/O assignment .....</b>	<b>47</b>
	<b>Revision history .....</b>	<b>50</b>

# 1 Overview

## 1.1 Features

- Three 5 V power supply options: Power jack, USB connector or daughterboard.
- Boot from user Flash, system memory or SRAM.
- I2S audio DAC, stereo audio jack.
- 2 GByte (or more) microSD card™.
- Both type A and B smartcard support.
- I2C compatible serial interface 64 Kbit EEPROM, MEMS and I/O expander.
- RS-232 communication.
- IrDA transceiver.
- USB-OTG full speed, USB MicroAB connector.
- IEEE-802.3-2002 compliant ethernet connector.
- Two channels of CAN2.0A/B compliant connection.
- Inductor motor control connector.
- JTAG and trace debug support.
- 3.2" 240x320 TFT color LCD with touch screen.
- Joystick with 4-direction control and selector.
- Reset, Wakeup, Tamper and User button.
- 4 color LEDs.
- RTC with backup battery.
- MCU consumption measurement circuit.
- Extension connector for daughterboard or wrapping board.
- RoHS compliant.

## 2 Hardware layout and configuration

The STM3210C-EVAL evaluation board is designed around the STM32F107VCT in a 100-pin LQFP package. The hardware block diagram [Figure 2](#) illustrates the connection between the STM32F107VCT and peripherals (LCD, EEPROM, MEMS, USART, IrDA, USB-OTG, ethernet, audio, CAN bus, smartcard, microSD card and motor control) and [Figure 3](#) helps you locate these features on the actual evaluation board.

**Figure 2. Hardware block diagram**

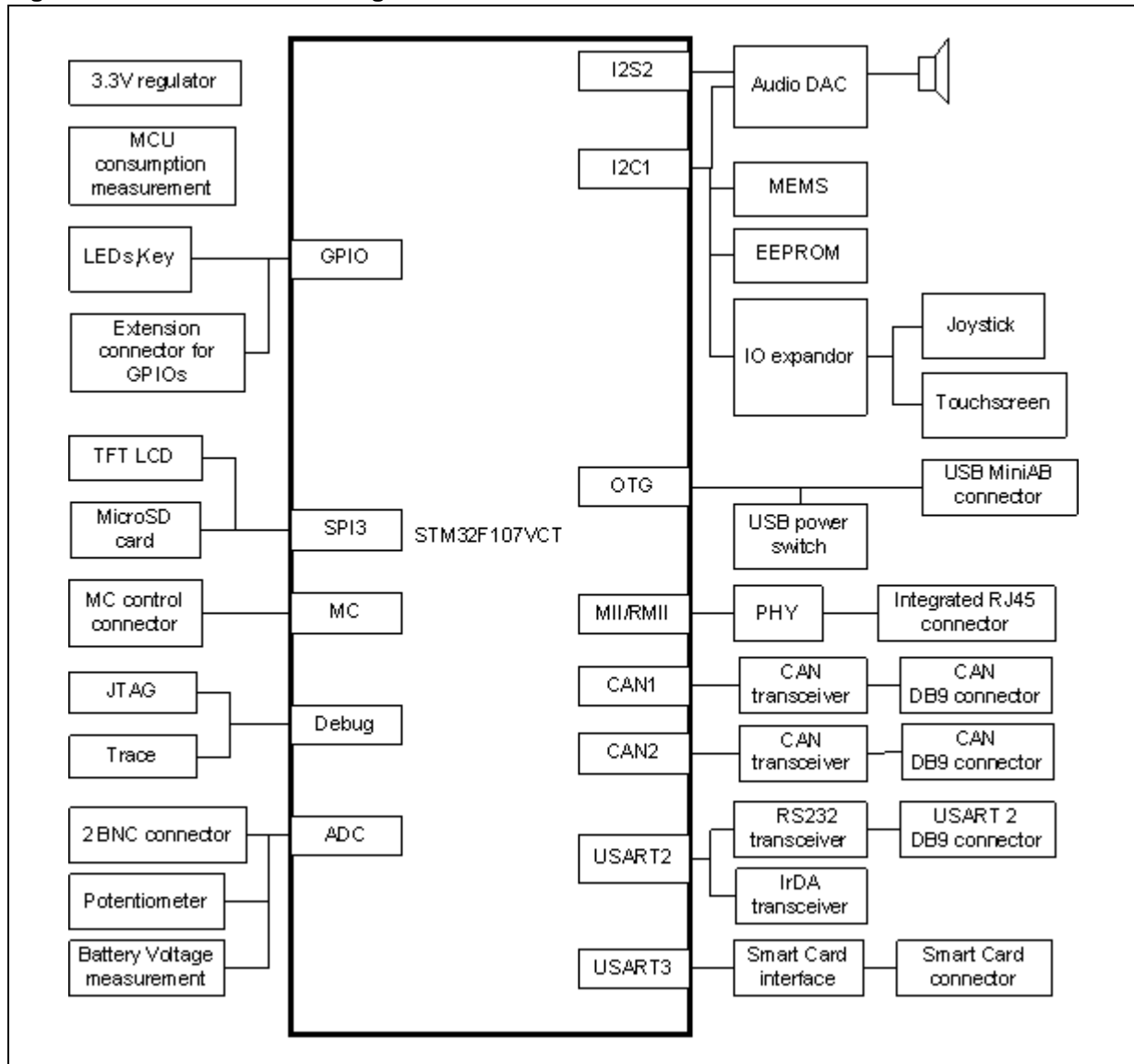
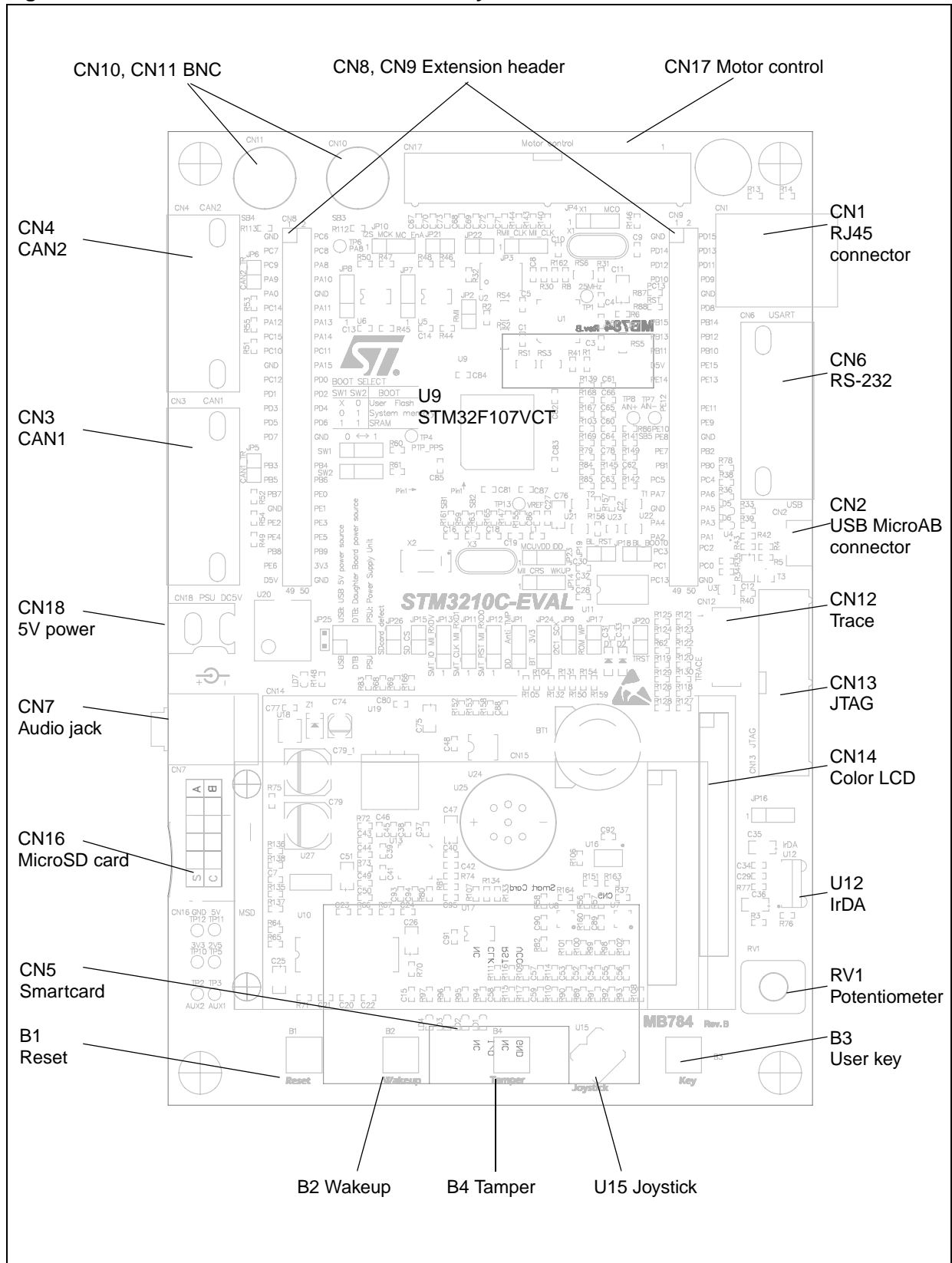

Figure 3. STM3210C-EVAL evaluation board layout



## 2.1 Power supply

The STM3210C-EVAL evaluation board is designed to be powered by a 5 V DC power supply and to be protected by PolyZen from a wrong power plug-in event.

It is possible to configure the evaluation board to use any of following three sources for the power supply.

- 5 V DC power adapter connected to CN18, the power jack on the board (PSU on silk screen for power supply unit).
- 5 V DC power with 500 mA limitation from CN2, the USB MicroAB connector (USB on silkscreen).
- 5 V DC power from both CN8 and CN9, the extension connector for daughterboard (DTB for daughterboard on silkscreen).

The power supply is configured by jumpers JP24 and JP25 as described in [Table 1](#).







**Table 1. Power related jumpers**

Jumper	Description	Configuration
JP25	JP25 selects one of the three possible power supply resources. For power supply jack (CN18) to the STM3210C-EVAL only, JP25 is set as shown: <b>(Default)</b>	
	For power supply from the daughterboard connectors (CN8 and CN9) to STM3210C-EVAL only, JP25 is set as shown:	
	For power supply from USB (CN2) to STM3210C-EVAL only, JP25 is set as shown:	
	For power supply from power supply jack (CN18) to both STM3210C-EVAL and daughterboard connected on CN8 and CN9, JP25 is set as shown to the right (the daughterboard must not have its own power supply connected):	
JP24	$V_{bat}$ is connected to 3.3 V power when JP24 is set as shown: <b>(Default)</b>	
	$V_{bat}$ is connected to battery when JP24 is set as shown:	

To enable MCU power consumption measurement, JP1, JP14 and JP23 should be re-configured as described in [Table 2](#).

**Warning:** When the board is connected to an USB host via CN2 and powered by an external power supply (JP25 is in position PSU) it is mandatory to remove the USB cable when the external power supply is OFF, else an unexpected current is provided by USB VBUS which maintains a residual voltage on the board.

**Table 2. MCU power consumption measurement related jumpers**

Jumper	Description	Configuration
JP1	PC13 is connected to anti-tamper button when JP1 is set as shown: <b>(Default)</b>	
	PC13 is connected to MCU consumption measurement circuit as IDD_CNT_EN signal when JP1 is set as shown. In this position PC13 is reserved to enable or clear the counter U24 used to measure IDD when the MCU is in low power mode.	
JP14	PA0 is connected to WUKP button and MCU power consumption measurement circuit as LP_WAKEUP when JP14 is set as shown:	
	PA0 is connected to ethernet PHY as signal MII_CRS when JP14 is set as shown: <b>(Default)</b>	
JP23	Connect +3.3V power to MCU directly when JP23 is set as shown: The MCU current consumption measurement can be done manually by an ammeter connected on PJ23 pin 1 & 2. <b>(Default)</b>	
	Connect +3.3 V power to MCU with MCU current-sampling resistor (1 ohm or 1 Kohm) in series and IDD current measurement circuit in parallel when JP23 is set as shown to the right. MCU power consumption measurement is enabled.	

The LED LD7 is lit when the STM3210C-EVAL board is powered by the 5 V correctly.



## 2.2 Boot option





The STM3210C-EVAL board is able to boot from:

- Embedded user Flash
- System memory with boot loader for ISP
- Embedded SRAM for debugging

The boot option is configured by setting switches SW1 (BOOT1) and SW2 (BOOT0).

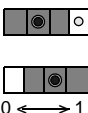
The BOOT0 can be configured also via the RS-232 connector CN6 when JP18 is fitted.

**Table 3. Boot related switches**

Switch	Boot from	Configuration
SW1 and SW2	STM3210C-EVAL boots from <b>User Flash</b> when SW2 is set as shown to the right. SW1 setting does not matter in this configuration. ( <b>Default</b> )	 SW2 0 ← → 1
	STM3210C-EVAL boots from <b>System Memory</b> when SW1 and SW2 are set as shown:	 SW1  SW2 0 ← → 1
	STM3210C-EVAL boots from <b>Embedded SRAM</b> when SW1 and SW2 are set as shown:	 SW1  SW2 0 ← → 1

## 2.3 Clock source

Two clock sources are available on the STM3210C-EVAL evaluation board for STM32F107VCT and RTC is embedded.

- X2, 32 kHz crystal for embedded RTC.
- X3, 25 MHz crystal with socket for an STM32F107VCT microcontroller, it can be removed from the socket when an internal RC clock is used.

## 2.4 Reset source

The reset signal of the STM3210C-EVAL board is active low and the reset sources include:

- Reset button, B1
- Debugging tools from JTAG connector CN13 and trace connector CN12
- Daughterboard from CN9
- RS-232 connector CN6 for ISP when JP19 is fitted.

**Table 4. Reset related jumper**

Jumper	Description
JP20	Enables reset of the STM32F107VCT embedded JTAG TAP controller each time a system reset occurs. JP20 connects the TRST signal from the JTAG connection with the system reset signal RESET#. Default setting: <b>Not fitted</b> .

## 2.5 Audio

The STM3210C-EVAL evaluation board supports stereo audio play by using an audio DAC CS43L22 connected to both an I2S2 port and one channel of the DAC of microcontroller STM32F107VCT. The CS43L22 can be configured via the I2C1 bus when JP9 is fitted (default setting). The automatic switch between the speaker and headphone is performed by both CS43L22 and the audio jack with plug detection pin.

## 2.6 EEPROM

A 64 Kbit EEPROM connected to the I2C1 bus of STM32F107VCT.

**Table 5. EEPROM related jumper**



Jumper	Description
JP17	The EEPROM is in Write protection mode when JP17 is open. Default setting: <b>Fitted</b> .

## 2.7 CAN



The STM3210C-EVAL evaluation board supports two channels of CAN2.0A/B compliant CAN bus communication based on a 3.3 V CAN transceiver. High-speed mode, standby mode and slope control mode are available and can be selected by setting JP7 for CAN1 and JP8 for CAN2.

*Note:* JP9 should be kept open for CAN2 to avoid any impact from pull-up on I2C1 bus.

**Table 6. CAN1 related jumpers**

Jumper	Description	Configuration
JP7	CAN1 transceiver works in standby mode when JP7 is set as shown:	
	CAN1 transceiver works in high-speed mode when JP7 is set as shown: <b>(Default)</b>	
	CAN1 transceiver works in slope control mode when JP7 is open.	
JP5	CAN1 terminal resistor is enabled when JP5 is fitted. Default setting: <b>Not fitted</b>	

**Table 7. CAN2 related jumpers**

Jumper	Description	Configuration
JP8	CAN2 transceiver works in standby mode when JP8 is set as shown:	
	CAN2 transceiver works in high-speed mode when JP8 is set as shown: <b>(Default)</b>	
	CAN2 transceiver works in slope control mode when JP8 is open.	
JP6	CAN2 terminal resistor is enabled when JP6 is fitted. Default setting: <b>Not fitted</b>	



## 2.8 RS-232 and IrDA

Both RS-232 and IrDA communications are supported by D-type 9-pin RS-232 connectors CN6 and IrDA transceiver U12 which connect to USART2 of STM32F107VCT on the STM3210C-EVAL evaluation board.

Two signals, Bootloader\_BOOT0 and Bootloader\_RESET, are added on the RS-232 connector for ISP support.

RS-232 or IrDA are selected by setting JP16.

**Table 8. RS-232 and IrDA related jumpers**

Jumper	Description	Configuration
JP16	USART2_RX is connected to RS-232 transceiver and RS-232 communication is enabled when JP16 is set as shown: <b>(Default)</b>	
	USART2_RX is connected to IrDA transceiver and IrDA communication is enabled when JP16 is set as shown:	
JP18	Bootloader_BOOT0 is disconnected from CN6 when JP18 is open. Default setting: <b>Not fitted</b>	
JP19	Bootloader_RESET is disconnected from CN6 when JP19 is open. Default setting: <b>Not fitted</b>	

## 2.9 Motor control



The STM3210C-EVAL evaluation board supports a three-phase brushless motor control via a 34-pin connector CN17, which provides all required control and feedback signals to and from a motor power-driving board.

Available signals on this connector include emergency stop, motor speed, 3 phase motor current, bus voltage, heat sink temperature from the motor driving board and 6 channels of PWM control signal going to the motor driving circuit.

JP 22 selects one of two kinds of synchronization methods for PFCs (power factor correction).

The I/O pins used on the motor control connector CN17 are multiplexed with some peripherals on the board; either motor control connector or multiplexed peripherals can be enabled by setting jumpers **JP10**, **JP21**, **JP22** and **JP26**.

**Table 9. Motor control related jumpers**

Jumper	Description	Configuration	Multiplexed peripherals
JP22	JP22 allows a PFC synchronization signal to be redirected to the timer 3 input capture 2 pin, additionally to the timer3 external trigger input. Default setting: <b>Not fitted</b> .		
JP21	JP21 should be kept open when encoder signal is input from pin31 of CN17 while it should be kept on close when analog signal is from pin31 of CN17 for special motor. Default setting: <b>Not fitted</b> .		
JP10	MC_EnA is enabled when JP10 is set as shown:		Audio
	I2S_MCK is enabled when JP10 is set as shown: ( <b>Default</b> )		
JP26	PE0 is connected to SD card detection when JP26 is fitted. JP26 should be kept open when PE0 is used as MC_PFCsync2. Default setting: <b>Fitted</b>		MicroSD card

## 2.10 Smartcard

STMicroelectronic's smartcard interface chip ST8024 is used on the STM3210C-EVAL board for asynchronous 3 V and 5 V smartcards.

It performs all supply protection and control functions based on the connections with the STM32F107VCT listed in [Table 10](#):







**Table 10. Connection between the ST8024 and STM32F107VCT**

Signals of ST8024	Description	Connect to STM32F107VCT
5V/3V	Smartcard power supply selection pin	PC0
I/OUC	MCU data I/O line	PD8
XTAL1	Crystal or external clock input	PD10
OFF	Detect presence of a card, interrupt to MCU	PE7
RSTIN	Card reset input from MCU	PD9
CMDVCC	Start activation sequence input (active low)	PE14

Some jumpers must be re-configured to enable smartcard.

*Note:* Two test points TP2 and TP3 are available on the board for AUX2 (auxiliary line to and from card C8) and AUX1 (auxiliary line to and from card C4).

**Table 11. Smartcard related jumpers**

Jumper	Description	Configuration
JP11	PD10 is connected to ethernet PHY as signal MII_RXD1 when JP11 is set as shown: <b>(Default)</b>	
	PD10 is connected to smartcard interface chip as signal smartcard_CLK when JP11 is set as shown:	
JP12	PD9 is connected to ethernet PHY as signal MII_RXD0 when JP12 is set as shown: <b>(Default)</b>	
	PD9 is connected to smartcard interface chip as signal smartcard_RST when JP12 is set as shown:	
JP13	PD8 is connected to ethernet PHY as signal MII_RX_DV/RMII_CRSDV when JP13 is set as shown: <b>(Default)</b>	
	PD8 is connected to smartcard interface chip as signal smartcard_IO when JP13 is set as shown:	

## 2.11 MicroSD card

The 2 GByte (or more) microSD card connected to SPI3 of STM32F107VCT is available on the board. MicroSD card detection is managed by the standard I/O port PE0.

JP15 must remain fitted to enable microSD card chip select.

**Table 12. MicroSD card related jumper**

Jumper	Description
JP15	JP15 enables microSD card chip select line. MicroSD card chip select is enabled when JP15 is fitted. JP15 should be kept open when PA4 is configured as a DAC output for audio DAC. Default setting: <b>Fitted</b> .
JP26	PE0 is connected to SD card detection when JP26 is fitted. JP26 should be kept on open when PE0 is used as MC_PFCsync2. Default setting: <b>Fitted</b> .

## 2.12 Analog input

Two BNC connectors CN10 and CN11 are connected to PB0 and PA7 of the STM32F107VCT as external analog input when a motor control connector is not used.

The 50 ohm terminal resistor can be enabled by closing solder bridge SB3 and SB4 for each BNC connector.

The test point TP7 and TP8 can be used for ADC precision measurement with BNC1 connector disconnected from PA7 by open SB5.

A low pass filter can be implemented for each BNC connector by replacing R141 and C64, R143 and C65 with the value of resistor and capacitor as requested by the end user's application.





There are also 3 analog signals available on the board:

1. 10 Kohm potentiometer RV1 connected to PC4.
2. IDD measurement output signal connected to PA6 for power consumption test in RUN, SLEEP and STOP mode.
3. Battery voltage measurement output signal connected to PC5. For battery voltage measurement VBAT is connected to ADC input using resistor divider since this voltage may be higher than MCU\_VDD when the battery is new. The resistor divider 2/3 needs to be pulled low by an I/O expander (VBAT\_DIV on EXP\_IO12) in order to avoid permanent current on this bridge.

## 2.13 Ethernet

The STM3210C-EVAL evaluation board supports 10M/100M ethernet communication by a PHY DP83848CVV (U1) and integrated RJ45 connector (CN1). Both MII and RMII interface modes are supported and can be selected by setting jumpers JP2, JP3 and JP4.

**Table 13. Ethernet related jumpers**

Jumper	Description	Configuration
JP2	JP2 selects MII or RMII interface mode. MII is enabled when JP2 is open while RMII interface mode is enabled when JP2 is fitted. Default setting: <b>Not fitted</b> .	
JP3	JP3 should be set as shown when MII interface mode is enabled. <b>(Default)</b>	
	JP3 should be set as shown when RMII interface mode is enabled.	
JP4	25 MHz clock for MII or 50 MHz clock for RMII is provided by MCO at PA8 when JP4 is set as shown: <b>(Default)</b>	
	25 MHz clock is provided by external crystal X1 (for MII interface mode only) when JP4 is set as shown:	
	JP4 has to be kept open when the clock is provided by external oscillator U2 (not fitted by default).	

*Note:* JP11, JP12, JP13 and JP14 are set to support ethernet by default, please verify the jumper configuration before ethernet demonstration.

*Note2:* Test point TP1 is connected to 25MHz clock output pin of Ethernet PHY U1 which provide 25MHz or 50MHz clock for system in MII or RMII mode.

*Note3:* Test point TP4 can be used for PTP\_PPS feature only when R45 is removed.

## 2.14 USB-OTG

The STM3210C-EVAL evaluation board supports USB-OTG full speed communication via a USB MicroAB connector (CN2) and a USB power switch (U3) connected to VBUS.

The evaluation board can be powered by this USB connection at 5 V DC with a 500 mA current limitation.

LED LD6 is lit:

- in Host mode when the power switch (U3) is ON (STM3210C-EVAL is acting as a USB host),
- in Device mode when a cable is connected to a PC (STM3210C-EVAL is acting as a USB device and VBUS is powered by another USB host).

LD5 is lit when over-current occurs in Host mode.

## 2.15 MEMS

An ST MEMS device LIS302DL is connected to the I2C1 bus of STM32F107VCT.

## 2.16 Development and debug support

The two debug connectors available on STM3210C-EVAL evaluation board are:

1. CN13, standard 20-pin JTAG interface connector that is compliant with the debug tools of ARM7 and ARM9 and cortex M3.
2. CN12, SAMTEC 20-pin connector FTSH-110-01-L-DV for both SWD and trace that is compliant with ARM CoreSight™ debug tools.



## 2.17 Display and input devices

The 3.2" TFT color LCD connected to SPI3 and 4 general purpose color LED's (LD 1,2,3,4) are available as display devices.

A touch screen connected to an I/O expander (U7), 4-direction joystick with selection key, general purpose button (B3), wakeup button (B2) and tamper detection button (B4) are available as input devices.

JP14 should be re-configured to enable wakeup button B2 which shares the same I/O as MII\_CRCS of the ethernet. You may refer to [Table 2](#) for details.

The STM3210C-EVAL board also supports a second optional 2.4" TFT LCD without touch screen that can be mounted on CN15 connector. The 2.4" TFT LCD is not populated by default.

[Table 14](#) shows both the LCD modules pin connections.

**Table 14. LCD modules**

3.2" TFT LCD with touch screen CN14 (default)			2.4" TFT LCD CN15 (optional)		
Pin on CN14	Description	Pin connection	Pin on CN15	Description	Pin connection
1	CS	PB2	1	CS	PB2
2	RS	-	2	SCL	PC10
3	WR/SCL	PC10	3	SDI	PC12
4	RD	-	4	RS	-
5	RESET	RESET#	5	WR	-
22	BL_GND	GND	6	RD	-
23	BL_control	+5V	7	SDO	PC11
24	VDD	3.3V	8	RESET	RESET#
25	VCI	3.3V	9	VDD	3.3V
26	GND	GND	10	VCI	3.3V
27	GND	GND	11	GND	GND
28	BL_VDD	+5V	12	GND	GND
29	SDO	PC11	13	BL_VDD	3.3V
30	SDI	PC12	14	BL_Control	3.3V
31	XL	IO Expander	15	BL_GND	GND
32	XR	IO Expander	16	BL_GND	GND
33	YD	IO Expander			
34	YU	IO Expander			

## 2.18 IDD measurement

Figure 4. STM3210C-EVAL IDD measurement circuit

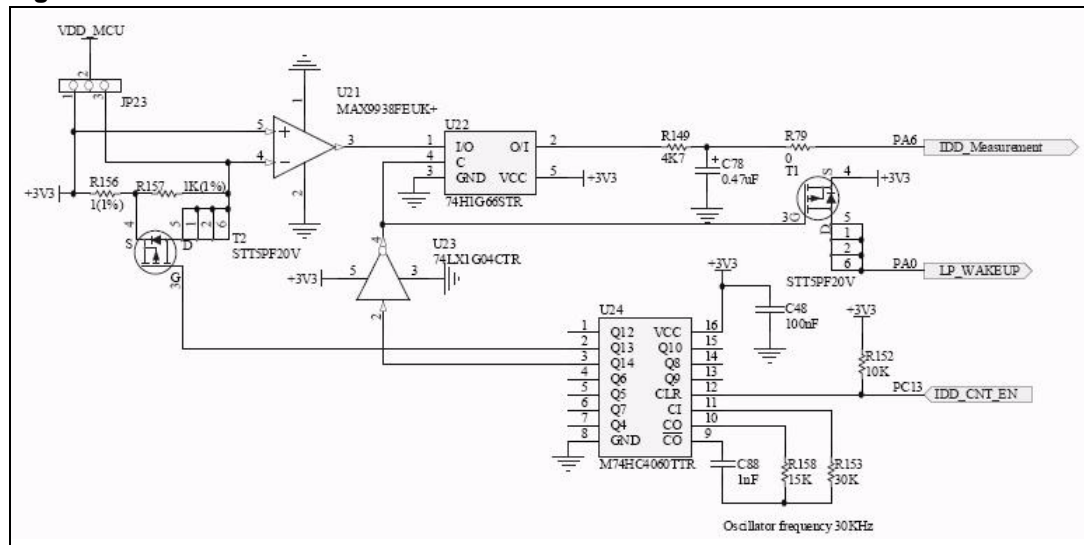

The circuit above is implemented on STM3210C-EVAL for IDD measurement.

In Run mode, IDD current is measured using MAX9938FEUK+ (U21) connected to the 10ohm shunt resistor. In this case IDD\_CNT\_EN remains high during measurement and JP23 jumper must be set to 2<->3.

In Stop or Standby mode, the operational amplifier MAX9938FEUK+ (U21) is connected on the 1 Kohm shunt resistor.

To measure a current corresponding to the Stop or Standby modes the procedure is:

1. Configure ADC to measure voltage on IDD\_measurement pin.
2. Configure PA0 as interrupt input on falling edge.
3. Enter in Stop or Standby modes with IDD\_CNT\_EN Low.
4. LP\_WAKEUP falling edge wakeup the MCU after 100 ms.
5. Start ADC conversion as soon as possible after wakeup in order to measure the voltage corresponding to Low power mode on 1 uF capacitor.
6. Reset the counter by programming IDD\_CNT\_EN High in less than 50 mS after the wakeup to avoid 1 Kohm to be connected later on VDD\_MCU.

In Stop or Standby modes, the 1K resistor is connected when T2 goes off after entering the Stop or Standby mode. Q13 output of the counter allows connection of the 1K resistor when the current IDD becomes very low. [Figure 5](#) shows the measurement timing.

**Figure 5. STM3210C-EVAL IDD Low power mode measurement timing diagram**

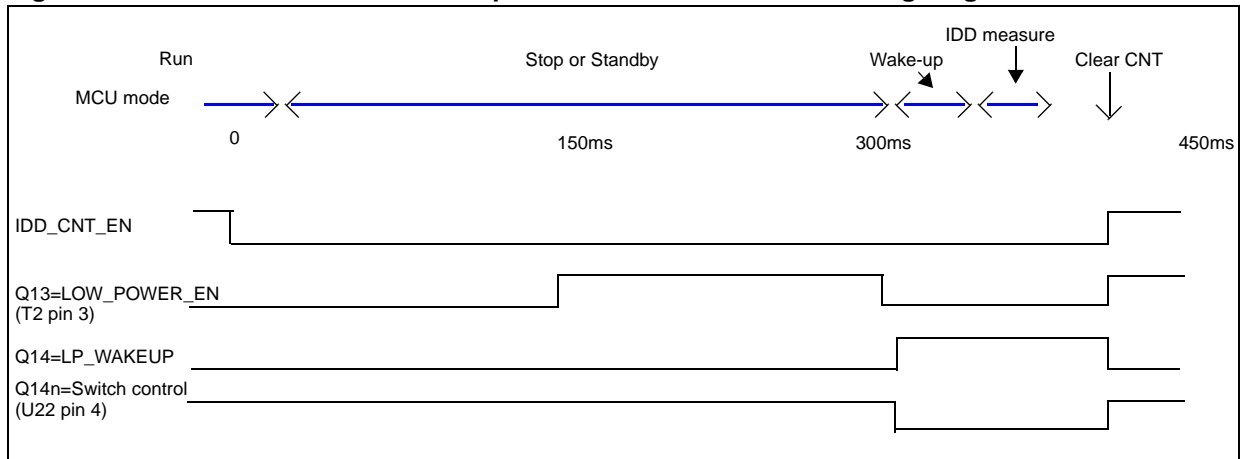

The Low power mode measurement procedure can be used in Stop or Standby modes if the IDD current does not exceed 60 uA, otherwise the Run mode measurement procedure should be used up to 60 mA.

## 3 Connectors

### 3.1 Motor control connector CN17

Figure 6. Motor control connector CN17 viewed from above the PCB

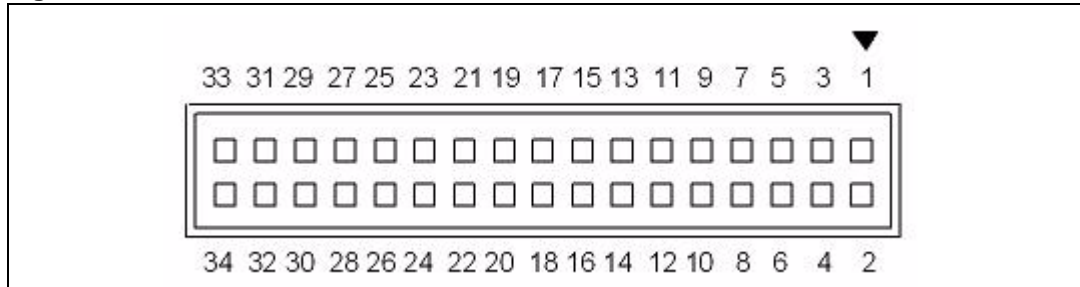

Table 15. Motor control connector CN17

Description	Pin of STM32F107VCT	Pin number of CN17	Pin number of CN17	Pin of STM32F107VCT	Description
Emergency stop	PE15	1	2		GND
PWM-UH	PE9	3	4		GND
PWM-UL	PE8	5	6		GND
PWM-VH	PE11	7	8		GND
PWM-VL	PE10	9	10		GND
PWM-WH	PE13	11	12		GND
PWM-WL	PE12	13	14	PA5	Bus voltage
PHASE A current	PA7	15	16		GND
PHASE B current	PB0	17	18		GND
PHASE C current	PB1	19	20		GND
NTC bypass relay	PD2	21	22		GND
Dissipative brake PWM	PA0	23	24		GND
+5V power	+5V	25	26	PC0	Heat sink temperature
PFC SYNC	PE0 and PD14	27	28		VDD_Micro
PFC PWM	PD15	29	30		GND
Encoder A	PC6 via JP10	31	32		GND
Encoder B	PC7	33	34	PC8	Encoder index

### 3.2 Analog input connector CN10 and CN11

Figure 7. Analog input connector CN10 and CN11 viewed from the bottom

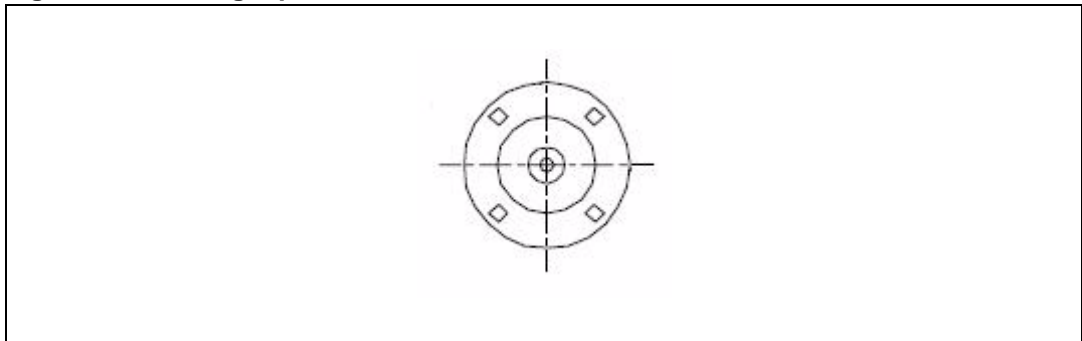

Table 16. Analog input connector CN10 and CN11

Pin number	Description	Pin number	Description
1	GND	4	GND
2	GND	5	Analog input PB0 and PA7 for CN10 and CN11 respectively
3	GND		

### 3.3 CAN D-type 9-pin male connector CN3 and CN4

Figure 8. CAN D-type 9-pin male connector CN3 and CN4 viewed from the front

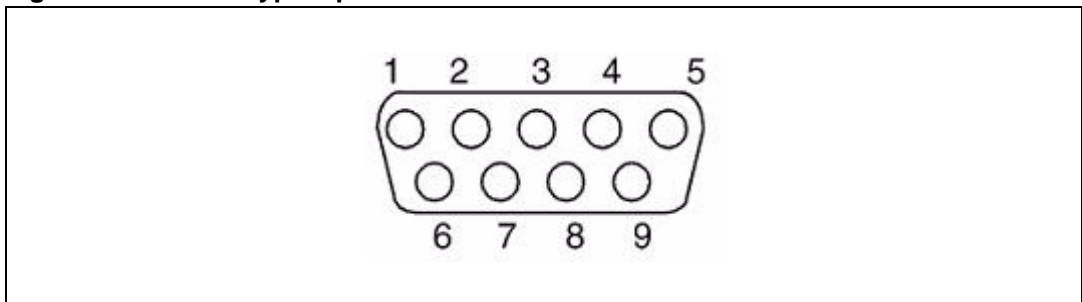

Table 17. CAN D-type 9-pin male connector CN3 and CN4

Pin number	Description	Pin number	Description
1,4,8,9	NC	7	CANH
2	CANL	3,5,6	GND

### 3.4 Ethernet RJ45 connector CN1

Figure 9. Ethernet RJ45 connector CN1 viewed from the front

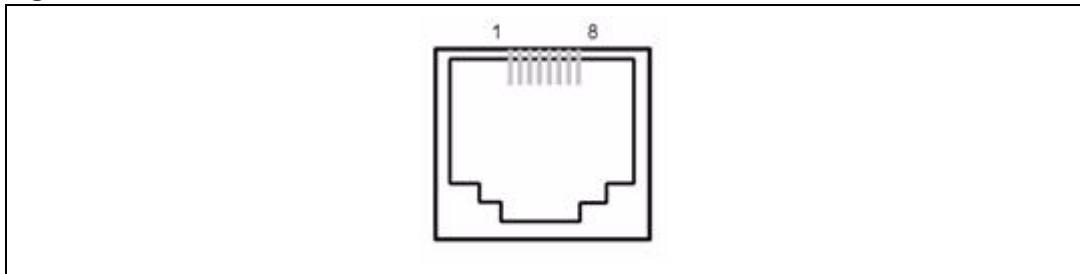

Table 18. RJ45 connector CN1

Pin number	Description	Pin number	Description
1	TxData+	2	TxData-
3	RxData+	4	Shield
5	Shield	6	RxData-
7	Shield	8	Shield

### 3.5 Trace debugging connector CN12

Figure 10. Trace debugging connector CN12 viewed from above the PCB

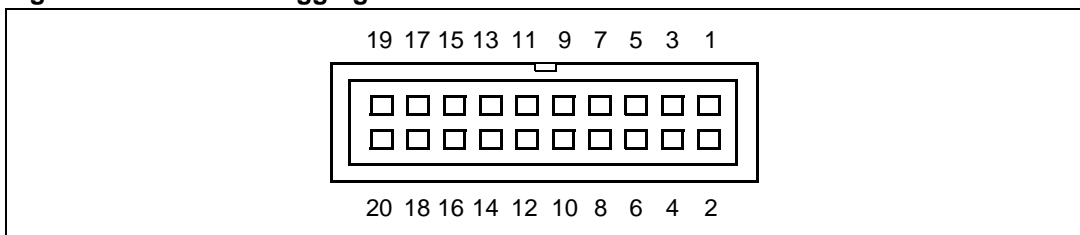

Table 19. Trace debugging connector CN12

Pin number	Description	Pin number	Description
1	3.3V power	2	TMS/PA13
3	GND	4	TCK/PA14
5	GND	6	TDO/PB3
7	KEY	8	TDI/PA15
9	GND	10	RESET#
11	GND	12	TraceCLK/PE2
13	GND	14	TraceD0/PE3 or SWO/PB3
15	GND	16	TraceD1/PE4 or nTRST/PB4
17	GND	18	TraceD2/PE5
19	GND	20	TraceD3/PE6

### 3.6 RS-232 connector CN6

Figure 11. RS-232 connector CN6 with ISP support viewed from the front

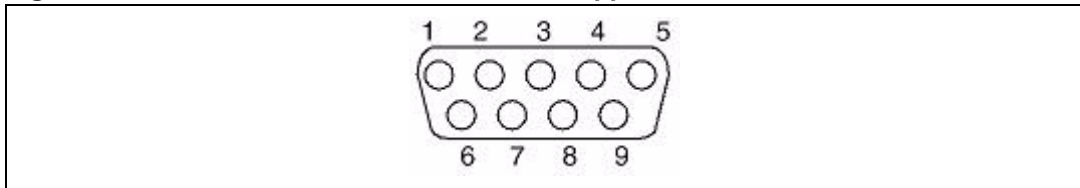

Table 20. RS-232 connector CN6 with ISP support

Pin number	Description	Pin number	Description
1	Bootloader_RESET	6	NC
2	RS232_RX (PD6)	7	NC
3	RS232_TX (PD5)	8	Bootloader_BOOT0
4	NC	9	NC
5	GND		

### 3.7 JTAG debugging connector CN13

Figure 12. JTAG debugging connector CN13 viewed from above the PCB

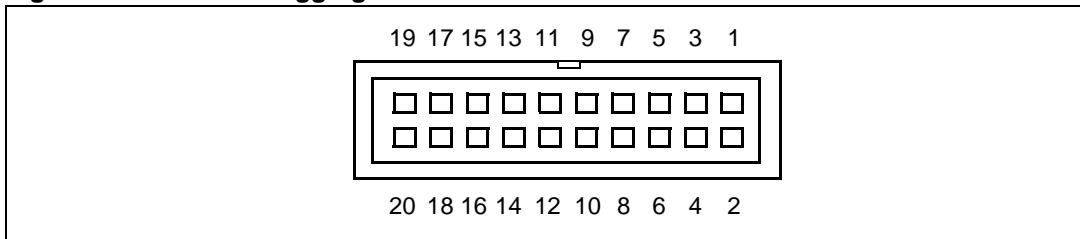

Table 21. JTAG debugging connector CN13

Pin number	Description	Pin number	Description
1	3.3V power	2	3.3V power
3	PB4	4	GND
5	PA15	6	GND
7	PA13	8	GND
9	PA14	10	GND
11	RTCK	12	GND
13	PB3	14	GND
15	RESET#	16	GND
17	DBGREQ	18	GND
19	DBGACK	20	GND

### 3.8 Daughterboard extension connector CN8 and CN9

Two 50-pin male headers CN8 and CN9 can be used to connect a daughterboard or standard wrapping board to the STM3210C-EVAL evaluation board. All 80 GPIOs are available on it.

The space between these two connectors and power position, GND and RESET pin are defined as a standard, which allows to develop common daughterboards for several evaluation boards.

The standard width between CN8 pin1 and CN9 pin1 is 2700 mils (68.58mm). This standard is implemented on the majority of evaluation boards.

Each pin on CN8 and CN9 can be used by a daughterboard after disconnecting it from the corresponding function block on the STM3210C-EVAL evaluation board. Please refer to [Table 22](#) and [Table 23](#) for details.

**Table 22. Daughterboard extension connector CN8**

Pin	Description	Alternative function	How to disconnect with function block on STM3210C-EVAL
1	GND	-	
3	PC7	MC	Disconnect STM3210C-EVAL board from motor power drive board
5	PC9	USB power switch On	Remove R36
7	PA9	USB VBUS	Remove R78
9	PA0	MC/Ethernet/WKUP	Keep JP14 open. Disconnect STM3210C-EVAL board from motor power drive board.
11	PC14 via SB1	32kHz oscillator	Remove R161, close SB1
13	PA12	USB_DP	Remove R43 or disconnect USB cable
15	PC15 via SB2	32kHz oscillator	Remove R59, close SB2
17	PC10	SPI1_CLK	
19	GND	-	
21	PC12	SPI1_MOSI	
23	PD1	CAN1_TX	
25	PD3	LD3	Remove R96
27	PD5	USART2_TX	
29	PD7	LD1	Remove R94
31			
33	PB3	TDO/SWO	
35	PB5	CAN2_RX	Remove R45
37	PB7	I2C1_SDA	Remove R132
39	GND	-	
41	PE2	Trace_CK	
43	PE4	Trace_D1	
45	PB8	MC	Disconnect STM3210C-EVAL board from motor power drive board



**Table 22. Daughterboard extension connector CN8 (continued)**

Pin	Description	Alternative function	How to disconnect with function block on STM3210C-EVAL
47	PE6	Trace_D3	
49	D5V		
2	PC6	I2S_MCK/MC	JP10 open
4	PC8	MC	Disconnect STM3210C-EVAL board from motor power drive board
6	PA8	MCO	JP4 open
8	PA10	USB_ID	Remove R38 or disconnect USB cable
10	GND		
12	PA11	USB_DM	Remove R42 or disconnect USB cable
14	PA13	TMS/SWDIO	
16	PA14	TCK/SWCLK	
18	PC11	SPI1_MISO	Remove R135 and LCD
20	PA15	TDI	
22	PD0	CAN1_RX	Remove R44
24	PD2	MC	Disconnect STM3210C-EVAL board from motor power drive board.
26	PD4	LD4	Remove R97
28	PD6	USART2_RX	Keep JP16 open
30	GND		
32			
34	PB4	TRST	Keep JP20 open
36	PB6	CAN2_TX/ I2C1_SCK	Keep JP9 open
38	PE0	MC/MicroSD card detection	Remove MicroSD card. Disconnect STM3210C-EVAL board from motor power drive board.
40	PE1	USB_Ove-current	Remove R35
42	PE3	Trace_D0	
44	PE5	Trace_D2	
46	PB9	User Button	Remove R104
48	3V3		
50	GND		

Table 23. daughterboard extension connector CN9

Pin	Description	Alternative Function	How to disconnect with component on STM3210C-EVAL board
1	GND	-	
3	PD14	MC	Keep JP22 open. Disconnect STM3210C-EVAL board from motor power drive board.
5	PD12	Ethernet	Remove RS2
7	PD10	Ethernet/Smartcard	Keep JP11 open
9	PC13 button B3	IDD_CNT_EN / Anti-tamper button B4	Keep JP1 open
11	RESET#	-	
13	PB15	I2S_DIN	
15	PB13	I2S_CK / Ethernet	Remove RS3
17	PB11	Ethernet	Remove RS3
19	D5V	-	
21	PE14	Smartcard_CMDVCC	Remove R166
23			
25	PE12	MC	Disconnect STM3210C-EVAL board from motor power drive board
27	PE10	MC	
29	PE8	MC	
31	PE7	Smartcard_OFF	Remove R69
33	PB1	MC	Remove R168
35	PC5	VBAT_voltage	Remove R154
37	PA7	MC	Remove R169
39	GND		
41	PA4	MicroSD card / Audio_DAC	Keep JP15 open
43	PA2	Ethernet	Remove R162
45	PC3	Ethernet	Remove RS1
47	PC1	Ethernet	
49	PC13	IDD_CNT_EN / Anti-tamper button B4	Keep JP1 open
2	PD15	MC	Disconnect STM3210C-EVAL board from motor power drive board
4	PD13	LD2	Remove R95
6	PD11	Ethernet	Remove RS1
8	PD9	Ethernet / Smartcard	Keep JP12 open
10	GND		
12	PD8	Ethernet / Smartcard	Keep JP13 open

**Table 23. daughterboard extension connector CN9 (continued)**

Pin	Description	Alternative Function	How to disconnect with component on STM3210C-EVAL board
14	PB14	IO_Expandor_INT	Remove R159
16	PB12	Ethernet / Audio	Remove RS3
18	PB10	Ethernet	Remove RS2
20	PE15	MC	Remove R139
22	PE13	MC	Disconnect STM3210C-EVAL board from motor power drive board
24			
26	PE11	MC	Disconnect STM3210C-EVAL board from motor power drive board
28	PE9	MC	
30	GND		
32	PB2	MC	Remove R168
34	PB0	MC	Remove R167
36	PC4	Potentiometer	Remove R103
38	PA6	IDD_Measurement	Remove R79
40	PA5	MC	Remove R84
42	PA3	MC / Ethernet	Keep JP10 open
44	PA1	Ethernet	Keep JP3 open
46	PC2	Ethernet	Remove RS1
48	PC0	MC / Smartcard	Remove R165
50	GND		

### 3.9 Audio jack CN7

A 3.5mm stereo audio jack CN7 connected to audio DAC is available on the STM3210C-EVAL board.

### 3.10 TFT LCD connector CN14

One 34-pin male header CN14 is available on the board to connect LCD module board MB785. Please refer to [Chapter 2.17](#) for detail.

### 3.11 MicroSD card connector CN16

Figure 13. MicroSD card connector CN16 viewed from the front

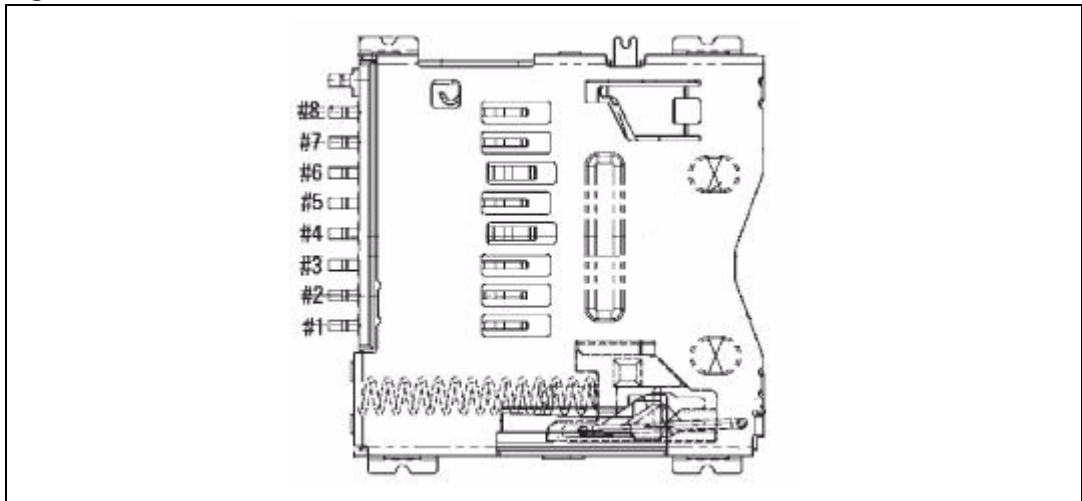

Table 24. MicroSD card connector CN16

Pin number	Description	Pin number	Description
1		5	MicroSDcard_CLK (PC10)
2	MicroSDcard_CS (PA4)	6	Vss/GND
3	MicroSDcard_DIN(PC12)	7	MicroSDcard_DOUT(PC11)
4	+3V3	8	
		9	MicroSDcard_detect (PE0)

### 3.12 USB MicroAB connector CN2

Figure 14. USB MicroAB connector CN2 viewed from the front

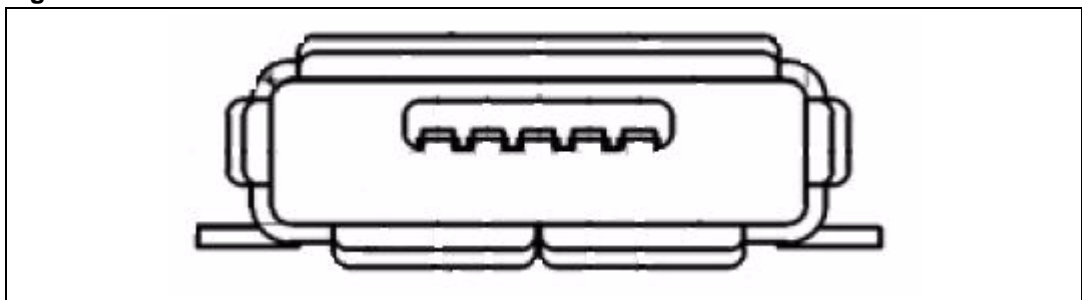

Table 25. USB MicroAB connector CN2

Pin number	Description	Pin number	Description
1	VBUS (PA9)	4	ID (PA10)
2	D- (PA11)	5	GND
3	D+ (PA12)		

### 3.13 Power connector CN18

Your STM3210C-EVAL evaluation board can be powered from a DC 5 V power supply via the external power supply jack (CN18) shown in [Figure 15](#). The central pin of CN18 must be positive.

**Figure 15. Power supply connector CN18 viewed from the front**

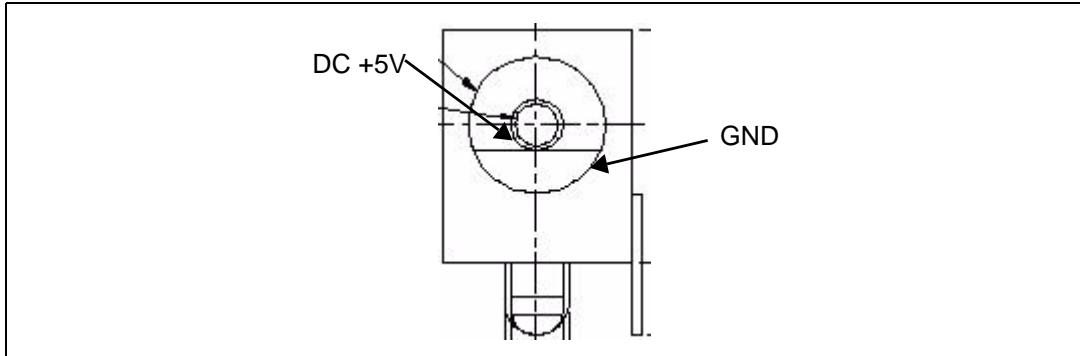

### 3.14 Smartcard connector CN5

**Figure 16. Smartcard connector CN5**

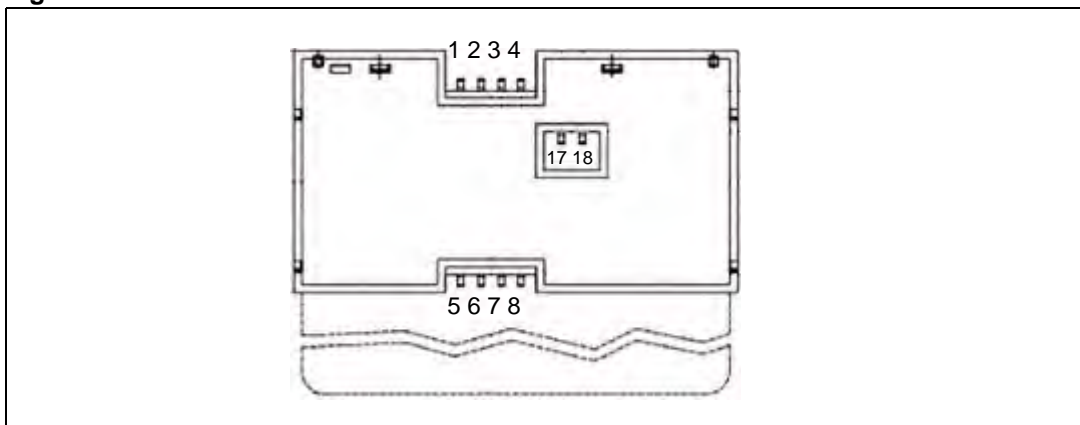

**Table 26. Smartcard connector CN5**

Pin number	Description	Pin number	Description
1	VCC	5	GND
2	RST	6	NC
3	CLK	7	I/O
4	NC	8	NC
17	Detection pin of card presence	18	Detection pin of card presence

# 4 Schematics

## 4.1 STM3210C

Figure 17. STM3210C

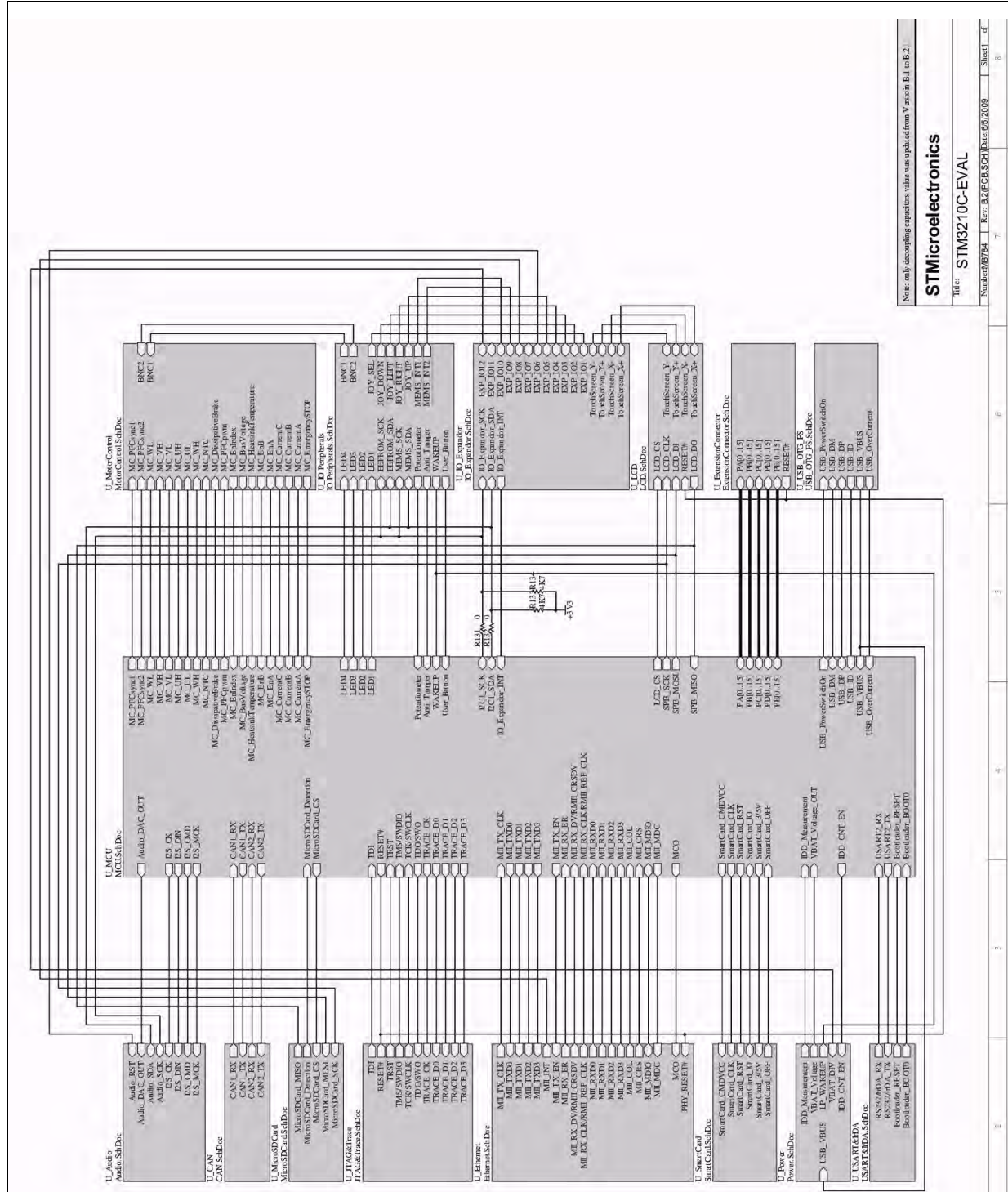

# 4.2 MCU

Figure 18. MCU

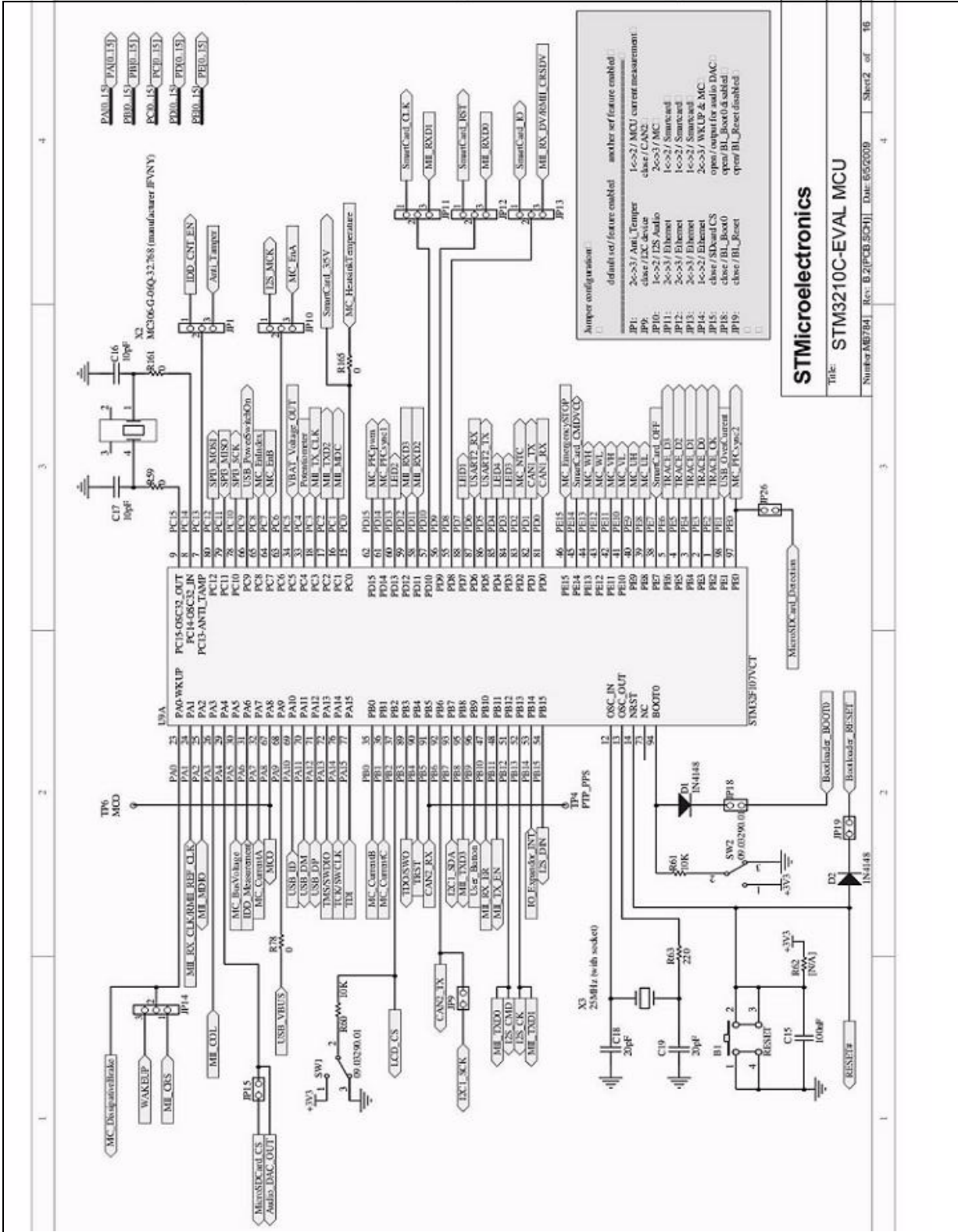

### 4.3 Ethernet

Figure 19. Ethernet

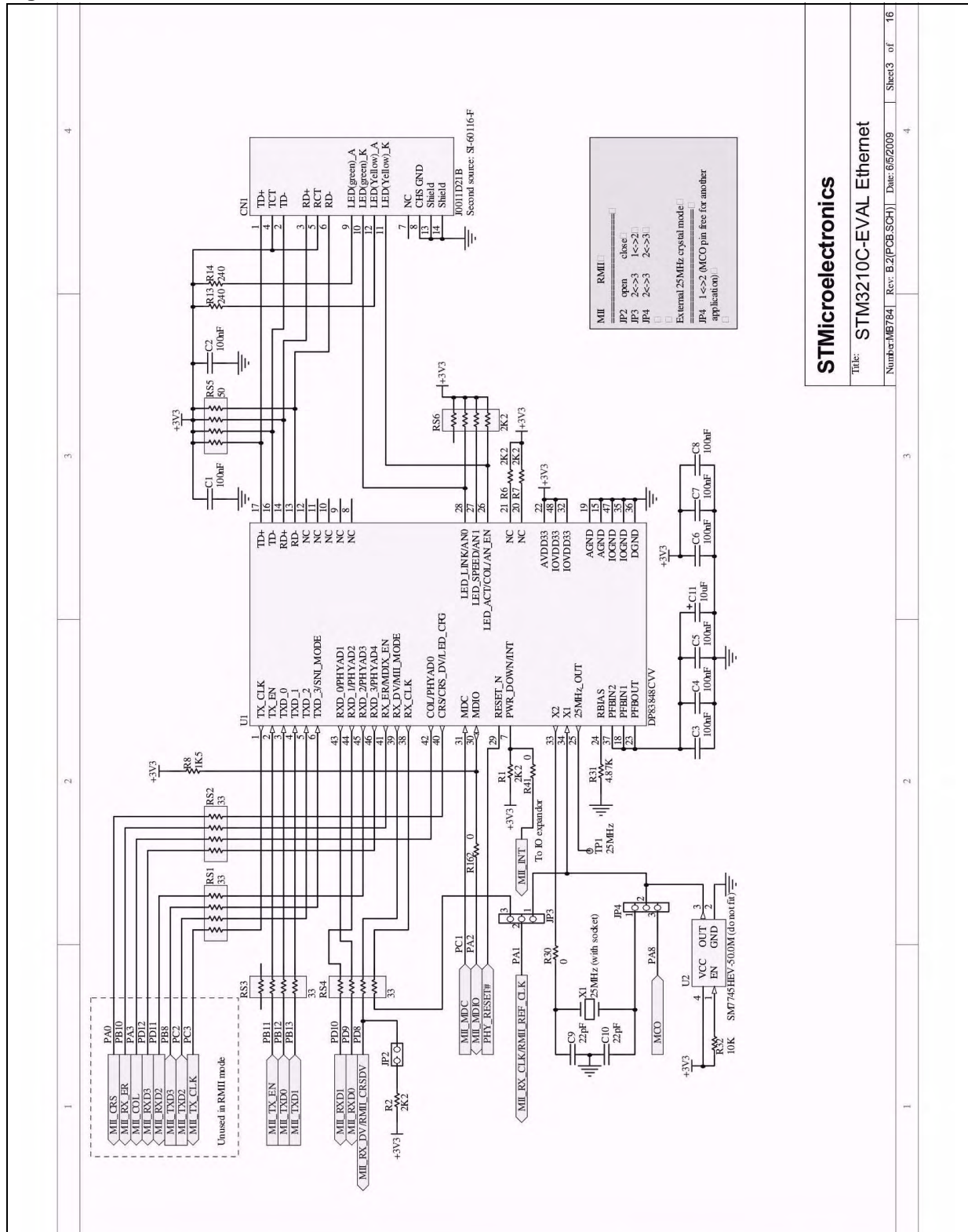

**STMicroelectronics**  
 Title: STM3210C-EVAL Ethernet  
 Number/MB764 Rev: B.2(PCB.SCH) Date: 6/5/2009 Sheet 3 of 16





### 4.4 Full speed USB-OTG

Figure 20. Full speed USB-OTG

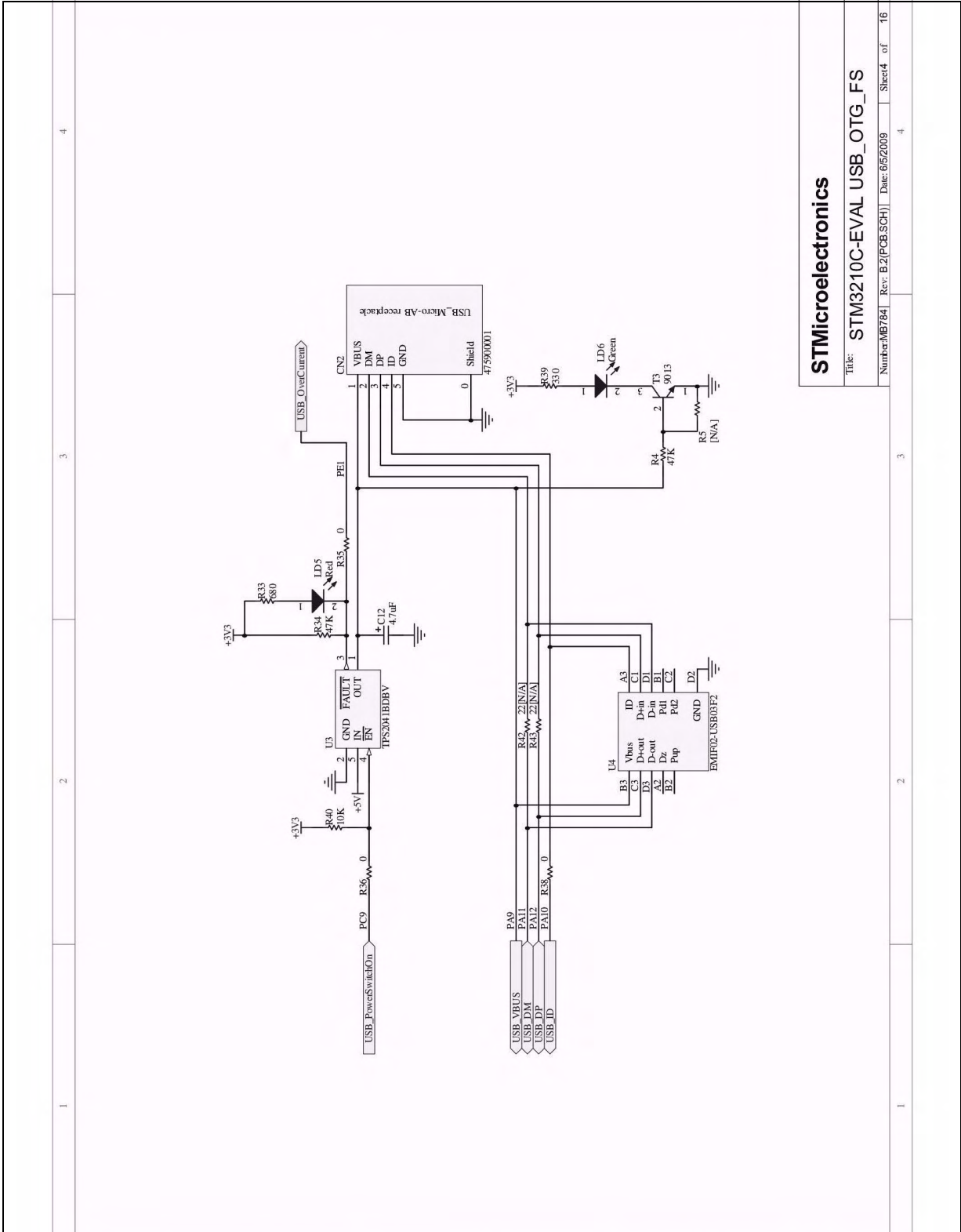

**STMicroelectronics**

Title: STM3210C-EVAL USB\_OTG\_FS

Number: MB784 Rev: B.2(PCB.SCH) Date: 6/5/2009 Sheet 4 of 16

# 4.5 Audio

Figure 21. Audio

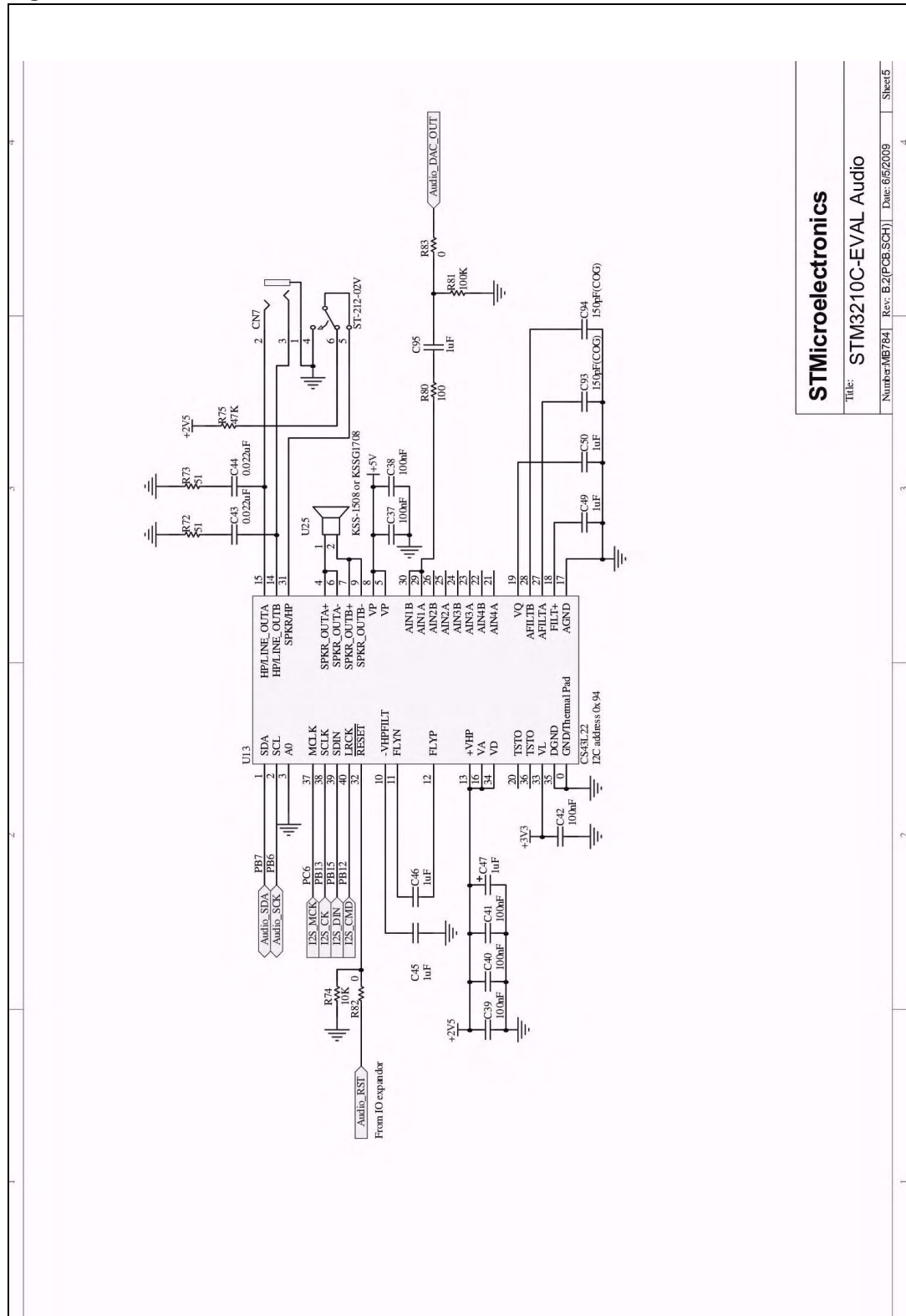

**STMicroelectronics**

Title: STM3210C-EVAL Audio

Number: MB784 | Rev: B.2 (PCB.SCH) | Date: 6/5/2009 | Sheet 5



# 4.6 LCD

Figure 22. LCD

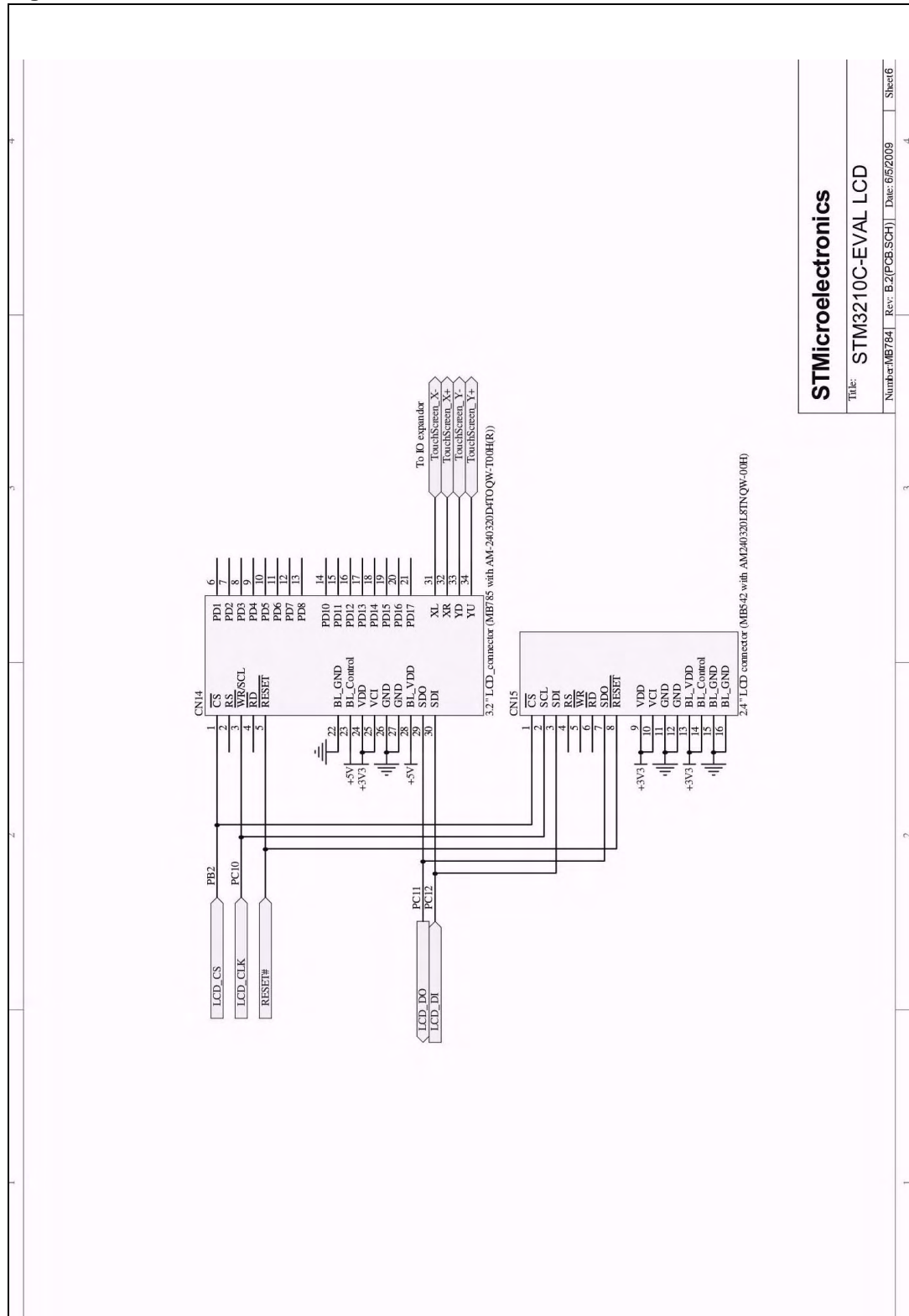

**STMicroelectronics**  
 Title: STM3210C-EVAL LCD  
 Number: MB784 Rev: B.2 (PCB SCH) Dwg: 6/52/09 Sheet 6

## 4.7 I/O expander

Figure 23. I/O expander

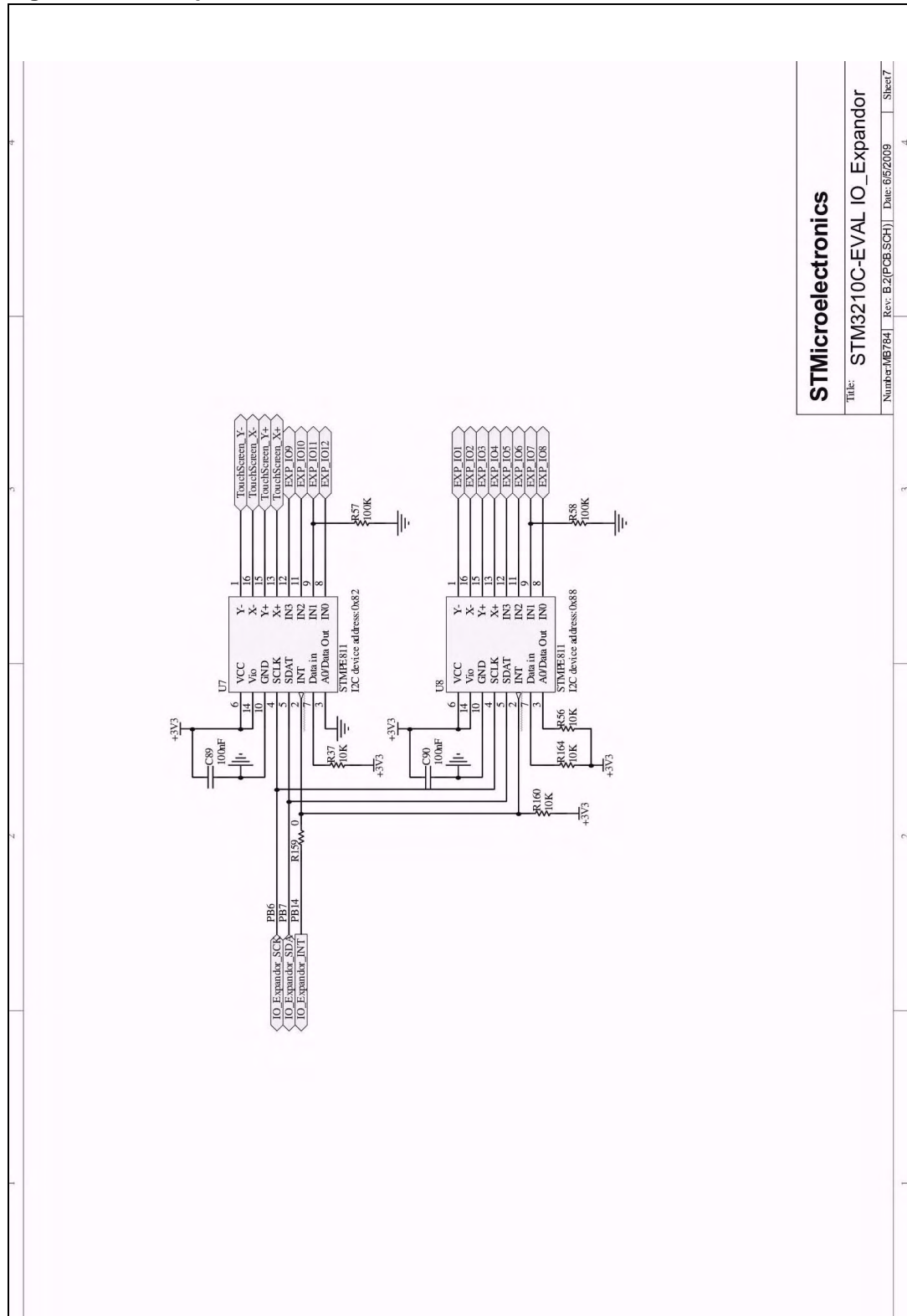

**STMicroelectronics**

Title: STM3210C-EVAL IO\_Expander

Number: MB784 | Rev: B.2 | PCB: SCH | Date: 6/5/2009 | Sheet 7

# 4.8 CAN

Figure 24. CAN

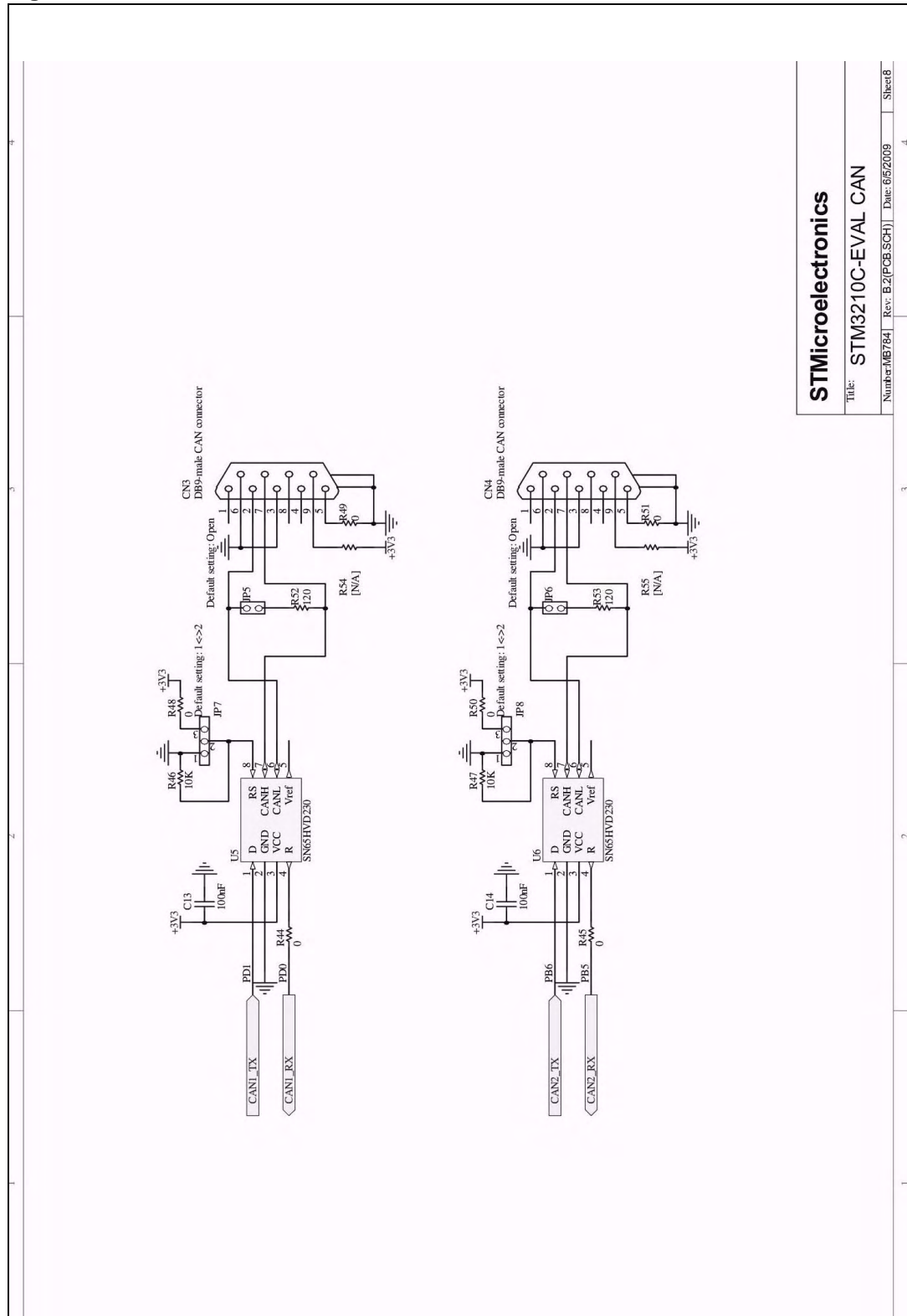

<b>STMicroelectronics</b>
Title: STM3210C-EVAL CAN
Number: MB784 Rev: B.2 (PCB.SCH) Date: 6/5/2009 Sheet 8

### 4.9 RS-232 and IrDA

Figure 25. RS-232 and IrDA

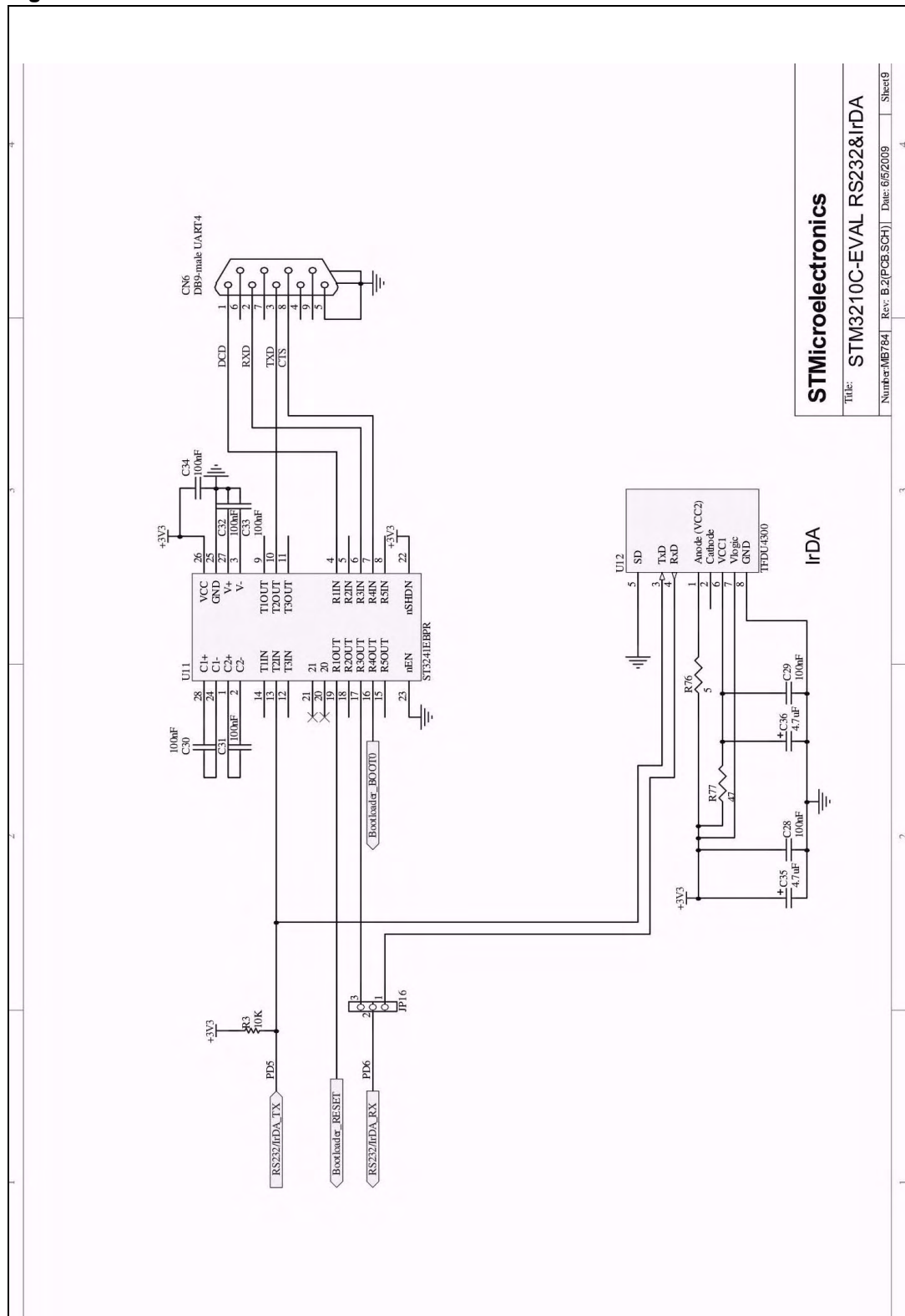

**STMicroelectronics**  
 Title: STM3210C-EVAL RS232&IrDA  
 Number: MB7841 Rev. B.2 (PCB.SCH) Date: 05/2009 Sheet 9



### 4.10 Smartcard

Figure 26. Smartcard

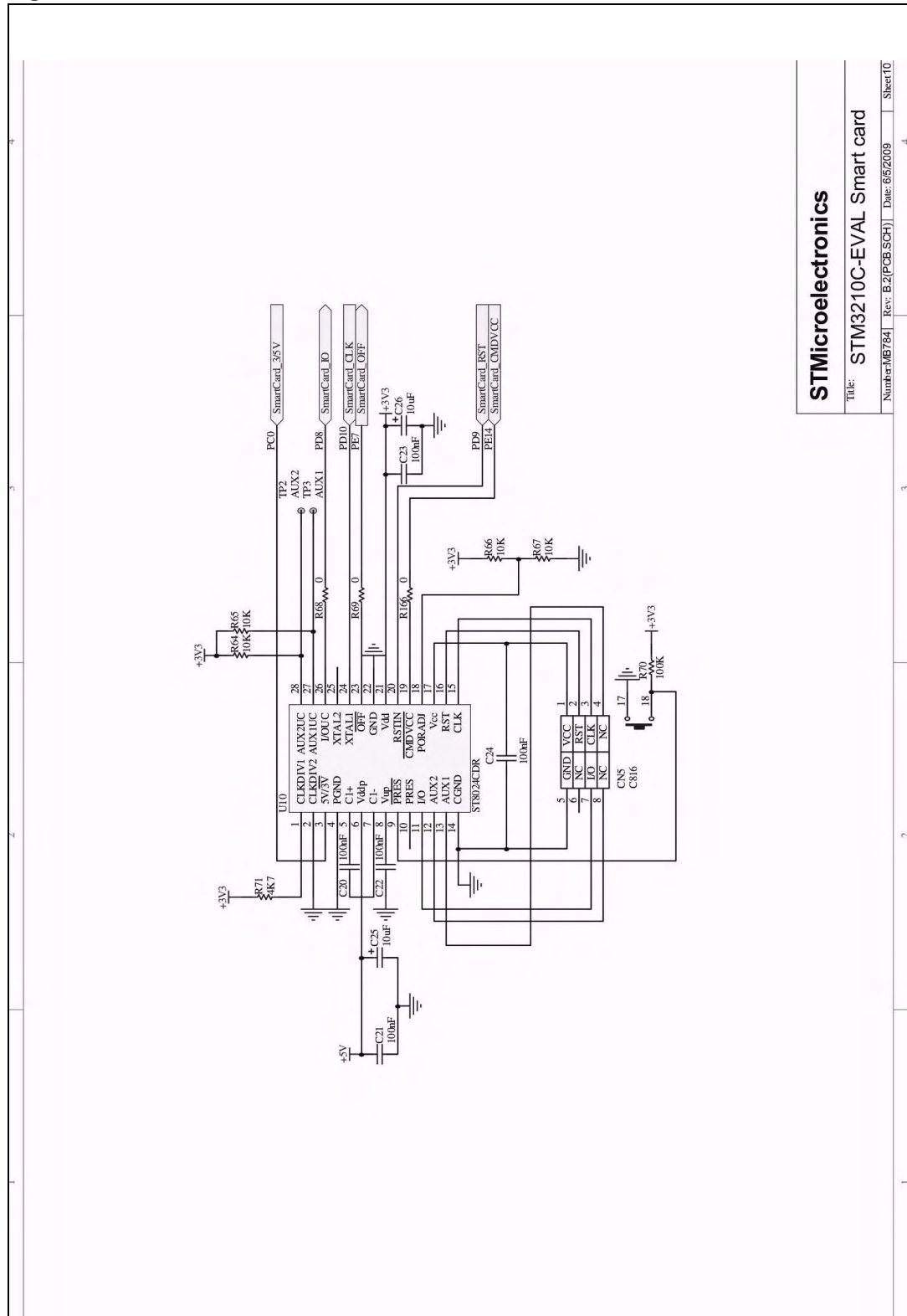

**STMicroelectronics**

Title: STM3210C-EVAL Smart card

Number: MB784 Rev: B.2(PCB.SCH) Dne: 6/5/2009 Sheet 10

# 4.11 Motor control

Figure 27. Motor control

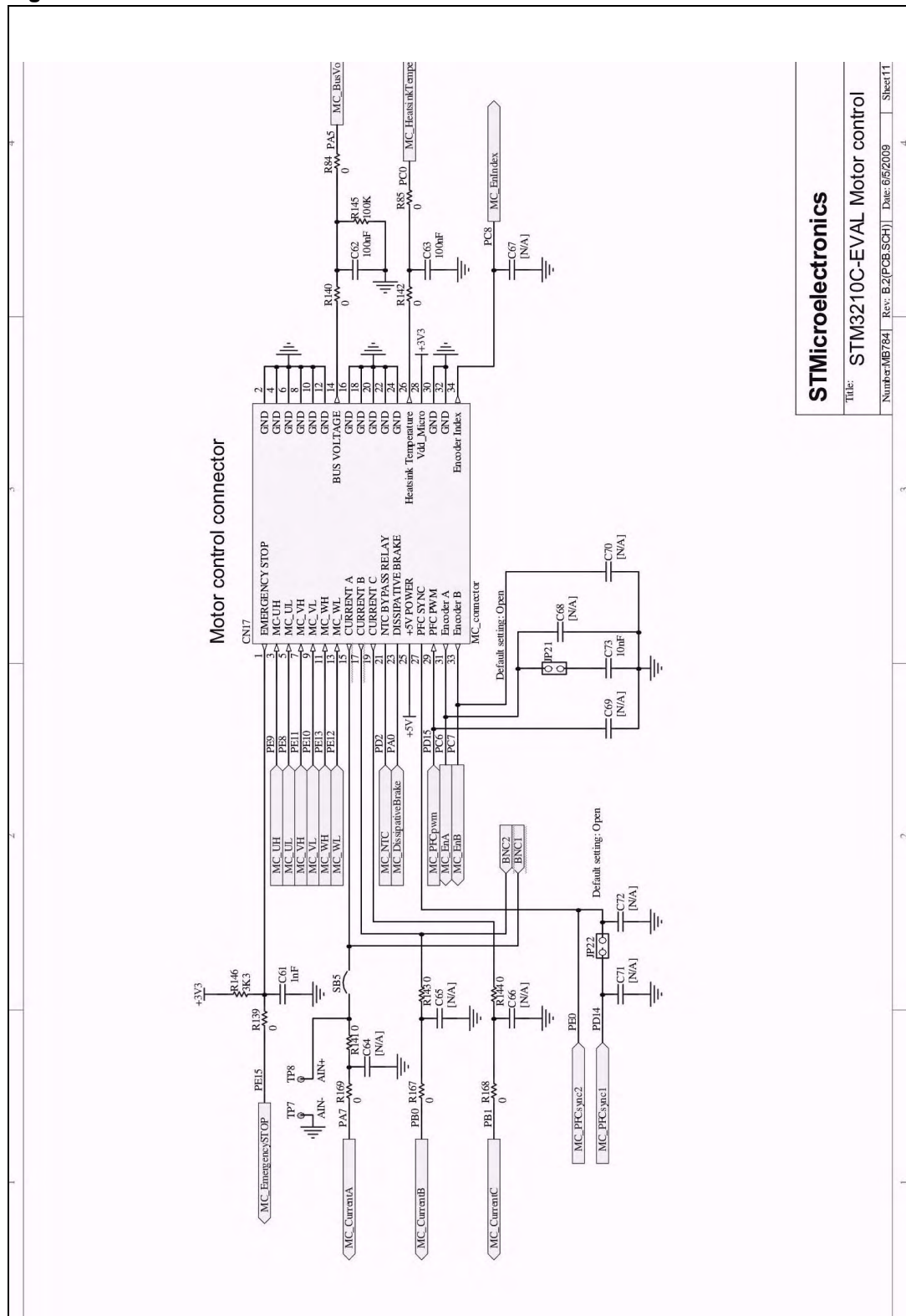

**STMicroelectronics**

Title: STM3210C-EVAL Motor control

Number: MB784 Rev: B.2 (PCB-SCH) Dni: 6/5/2009 Sheet 11





# 4.12 I/O peripherals

Figure 28. I/O Peripherals

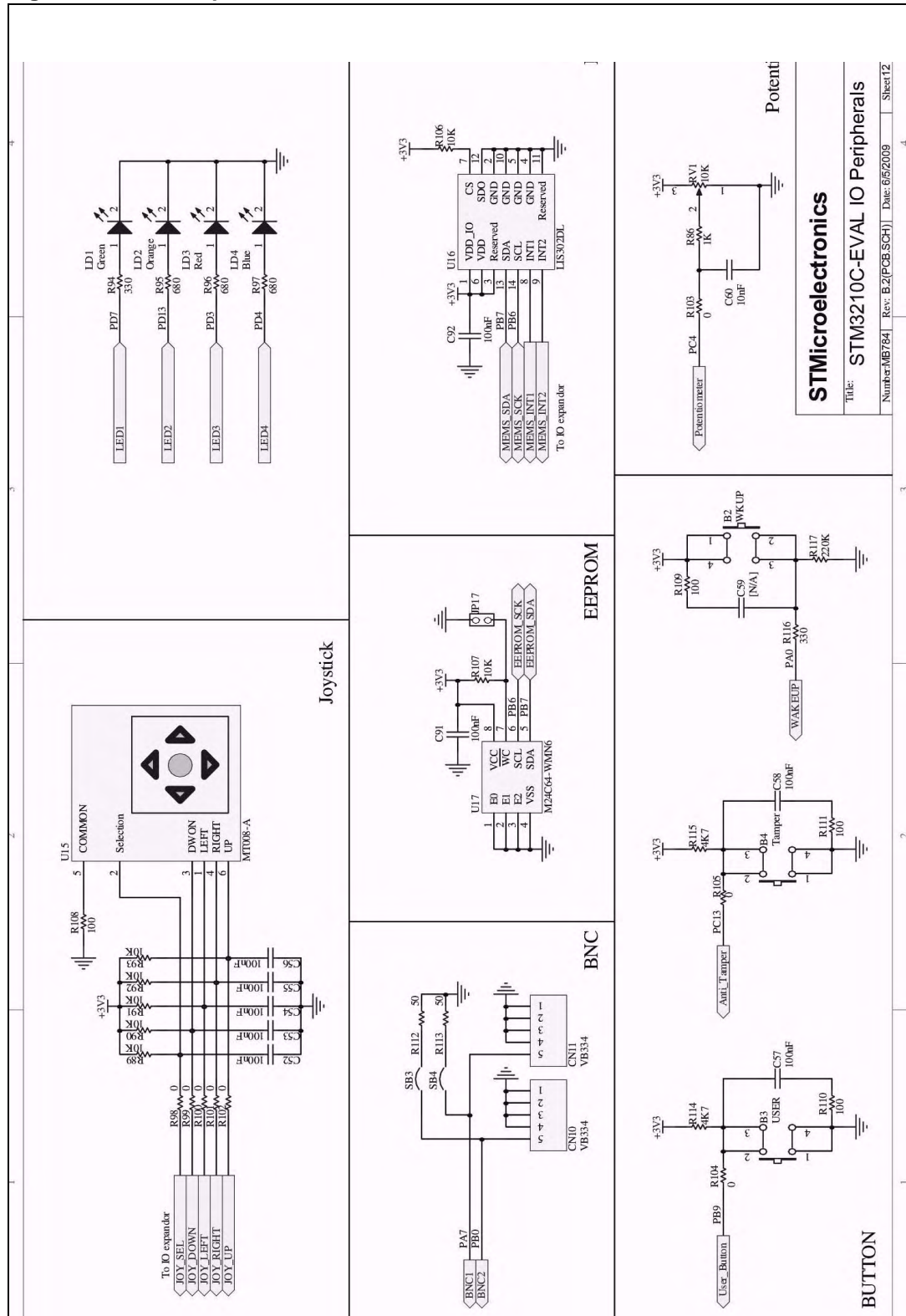

**STMicroelectronics**

Title: STM3210C-EVAL IO Peripherals  
 Number: MB784 | Rev: B.2(PCB.SCH) | Date: 6/5/2009 | Sheet 12



## 4.13 Extension connector

Figure 29. Extension connector

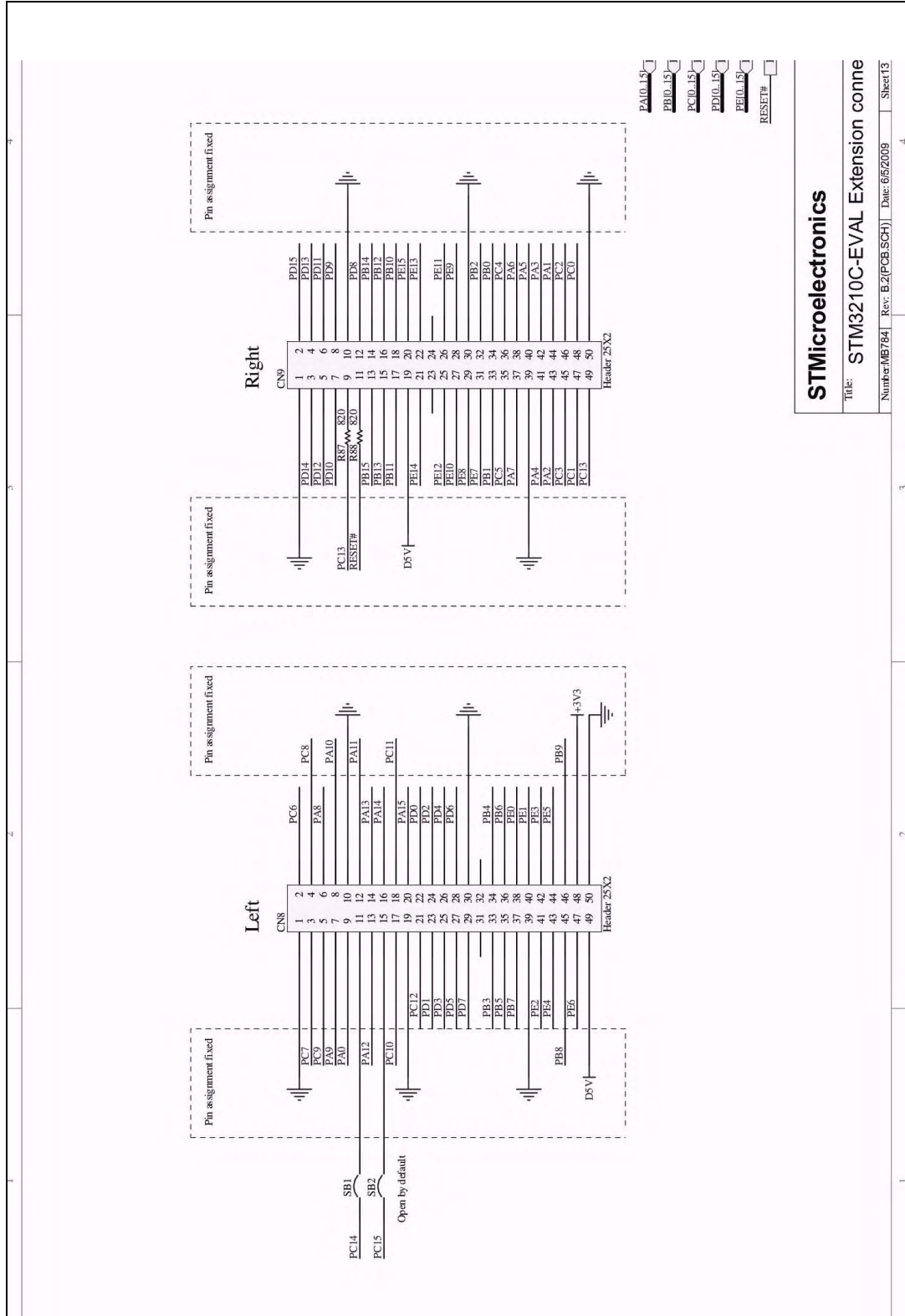

**STMicroelectronics**

Title: STM3210C-EVAL Extension conn  
 Number: MB7941 Rev.: B.2(PCB.SCH) Date: 6/5/2009 Sheet: 13



### 4.14 JTAG and trace

Figure 30. JTAG and trace

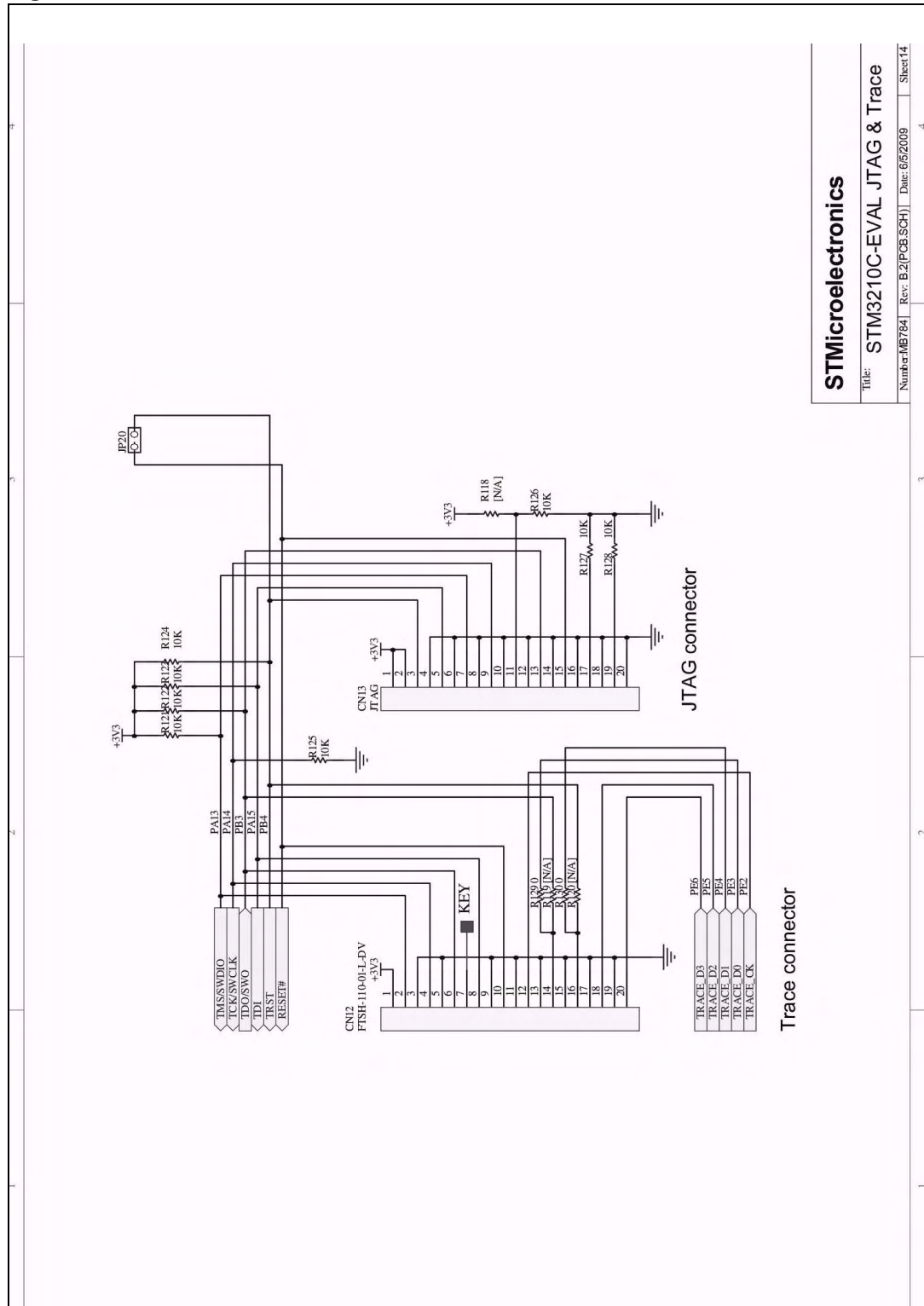

<b>STMicroelectronics</b>	
Title: STM3210C-EVAL JTAG & Trace	
Number: MB764	Rev: B2[PCB.SCH]
Date: 6/5/2009	Sheet 14

### 4.15 MicroSD card

Figure 31. MicroSD card

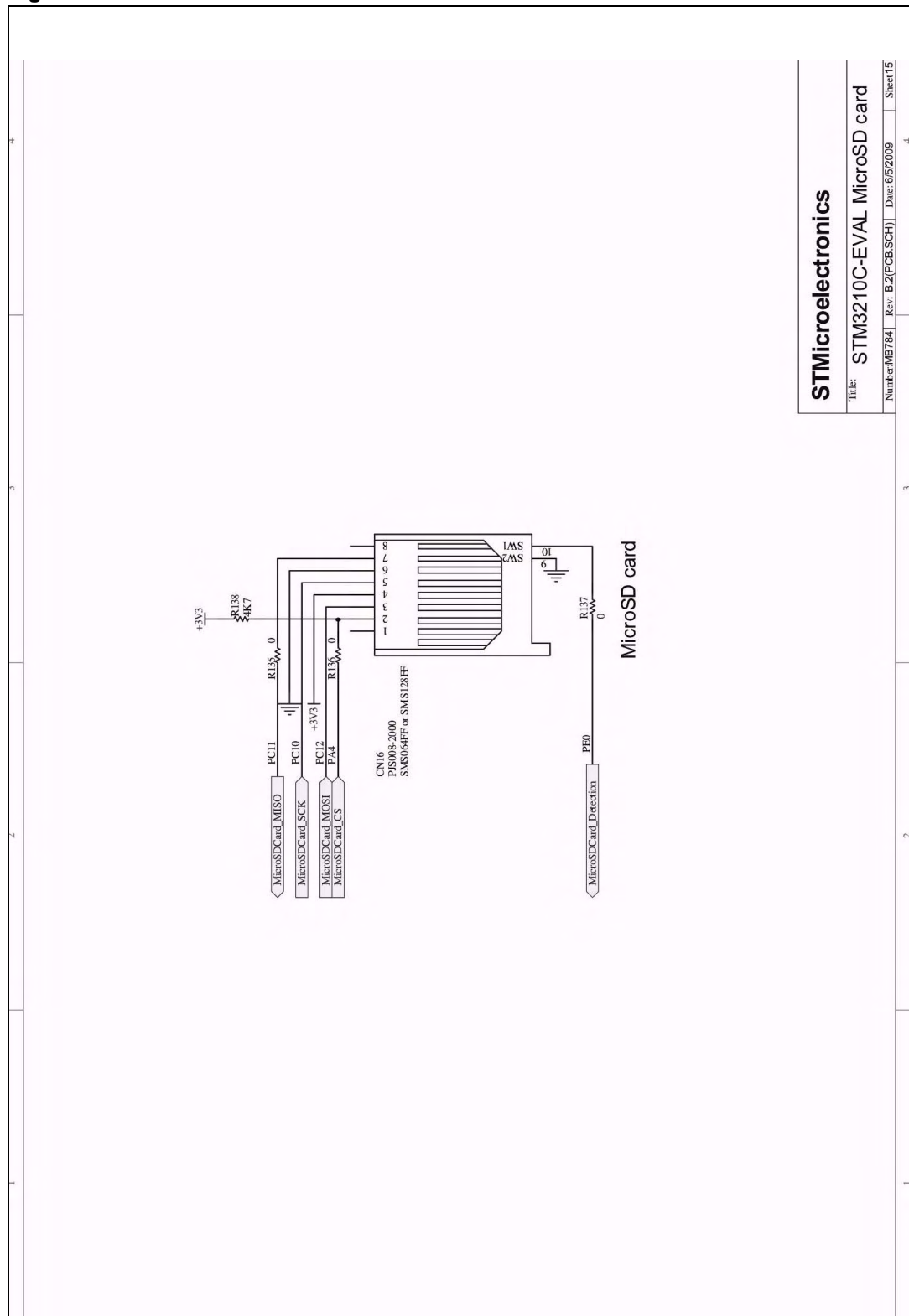

<b>STMicroelectronics</b>	
Title: STM3210C-EVAL MicroSD card	
Number: MB764	Rev: B2(PCB.SCH)
Date: 6/5/2009	Sheet 15

# 4.16 Power

Figure 32. Power

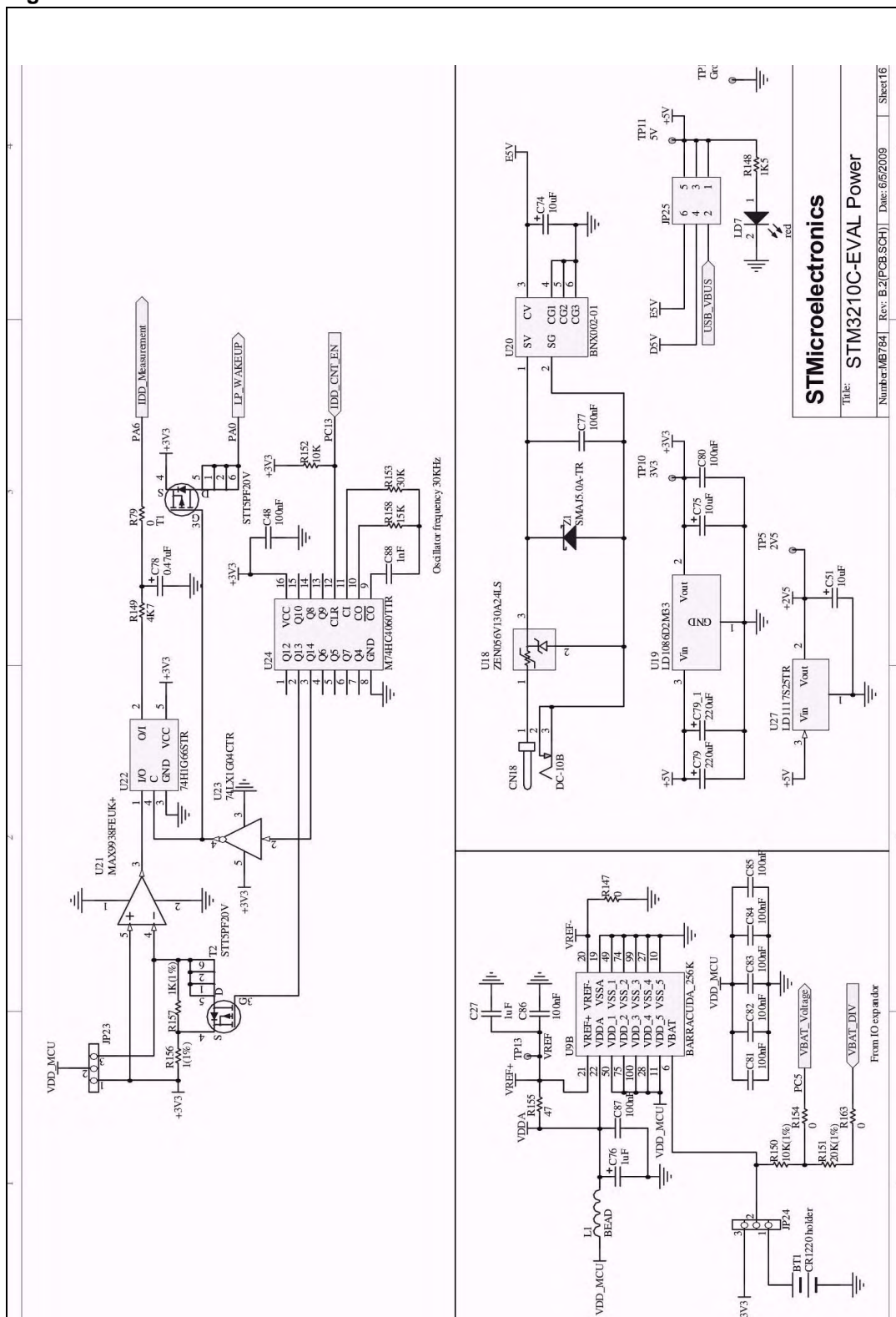

### 4.17 3.2" LCD module with SPI and 16-bit interface

Figure 33. 3.2" LCD module with SPI and 16-bit interface

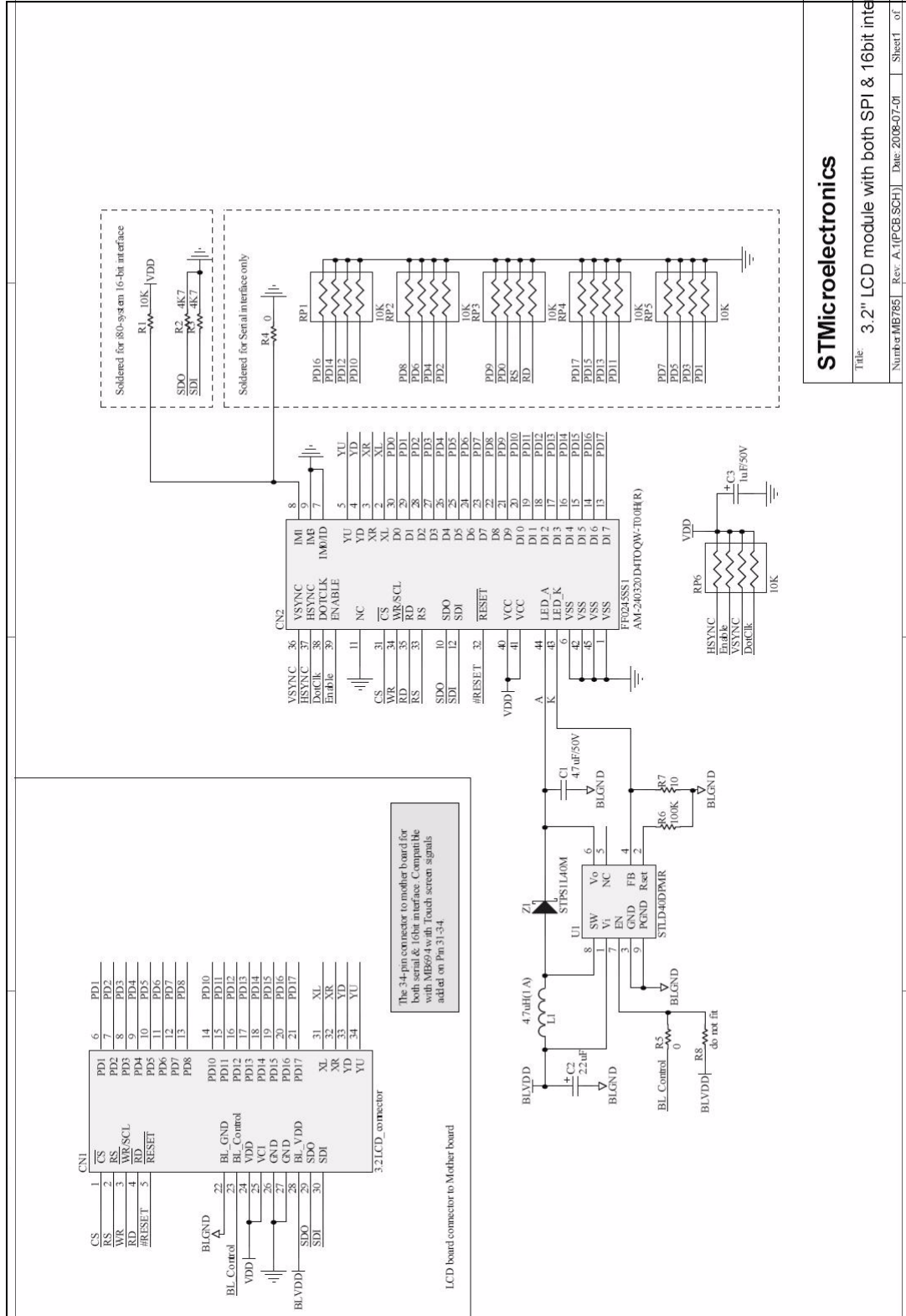

STMicroelectronics

Title: 3.2" LCD module with both SPI & 16bit inte  
Number MB785 | Rev. A.1(PCB.SCH) | Date: 2016-07-01 | Sheet 1 of



## Appendix A STM3210C-EVAL I/O assignment

**Table 27. STM3210C-EVAL I/O assignment**

Pin No.	Pin name	STM3210C-EVAL I/O assignment
1	PE2	Trace_CK
2	PE3	Trace_D0
3	PE4	Trace_D1
4	PE5	Trace_D2
5	PE6	Trace_D3
6	VBAT	Battery
7	PC13-ANTI_TAMP	Anti-tamper button / IDD_CNT_EN
8	PC14-OSC32_IN	32K OSC
9	PC15-OSC32_OUT	32K OSC
10	VSS_5	GND
11	VDD_5	+3V3
12	OSC_IN	25MHz OSC
13	OSC_OUT	25MHz OSC
14	NRST	RESET#
15	PC0	MC_ADC10 pin 26 (heatsinktemp) / SmartCard_3/5V
16	PC1	ETHER_MDC
17	PC2	ETHER_TXD2
18	PC3	ETHER_TX_CLK
19	VSSA	GND
20	VREF-	GND
21	VREF+	+3V3
22	VDDA	+3V3
23	PA0-WKUP	ETHER_CRS / IDD_WAKEUP / MC_TIM5_CH1 pin 23 (Dissip_brake)
24	PA1	ETHER_RX_CLK
25	PA2	ETHER_MDIO
26	PA3	ETHER_COL
27	VSS_4	GND
28	VDD_4	+3V3
29	PA4	MicroSD card CS / Audio_DAC
30	PA5	MC_ADC5 pin 14 (Bus voltage)
31	PA6	IDD_Measure
32	PA7	MC_ADC7 pin 15 (Current A)/BNC1

**Table 27. STM3210C-EVAL I/O assignment (continued)**

Pin No.	Pin name	STM3210C-EVAL I/O assignment
33	PC4	Potentiometer
34	PC5	VBAT_measure
35	PB0	MC_ADC8 pin 17(Current B)/BNC2
36	PB1	MC_ADC9 pin 19 (Current C)
37	PB2	Boot1/ LCD CS
38	PE7	SmartCard_OFF
39	PE8	MC_TIM1_CH1N pin 5 (UL)
40	PE9	MC_TIM1_CH1 pin 3 (UH)
41	PE10	MC_TIM1_CH2N pin 9 (VL) / CS_Sdcard
42	PE11	MC_TIM1_CH2 pin 7 (VH)
43	PE12	MC_TIM1_CH3N pin 13 (WL)
44	PE13	MC_TIM1_CH3 pin 11 (WH)
45	PE14	SmartCard_CMDVCC
46	PE15	MC_TIM1_BKIN pin 1 (STOP)
47	PB10	ETHER_RX_ER
48	PB11	ETHER_TX_EN
49	VSS_1	GND
50	VDD_1	+3V3
51	PB12	ETHER_TXD0 / Audio_WS
52	PB13	ETHER_TXD1 / Audio_CK
53	PB14	IO_EXP_INT
54	PB15	Audio_SD
55	PD8	ETHER_RX_DV / SmartCard_IO
56	PD9	ETHER_RXD0 / SmartCard_Reset
57	PD10	ETHER_RXD1 / SmartCard_CK
58	PD11	ETHER_RXD2
59	PD12	ETHER_RXD3
60	PD13	LED2
61	PD14	MC_TIM3_CH2 pin 27(PFCsync1)
62	PD15	MC_TIM3_CH3 pin 29 (PFCpwm)
63	PC6	MC_TIM4_CH3 pin 31 (EnA) / Audio MCK
64	PC7	MC_TIM4_CH4 pin 33 (EnB)
65	PC8	MC_TIM5_CH4 pin 34 (Index)
66	PC9	OTG_PPWR
67	PA8	MCO



Table 27. STM3210C-EVAL I/O assignment (continued)

Pin No.	Pin name	STM3210C-EVAL I/O assignment
68	PA9	OTG_VBUS
69	PA10	OTG_ID
70	PA11	OTG_DM
71	PA12	OTG_DP
72	PA13	Debug TMS
73	NC	
74	VSS_2	GND
75	VDD_2	+3V3
76	PA14	Debug TCK
77	PA15	Debug TDI
78	PC10	SCL_Sdcard_LCD
79	PC11	MISO_Sdcard_LCD
80	PC12	MOSI_Sdcard_LCD
81	PD0	CAN1 RX
82	PD1	CAN1 TX
83	PD2	MC_IO pin21(NTC)
84	PD3	LED3
85	PD4	LED4
86	PD5	UART2 TX / IrDA TX
87	PD6	UART2 RX / IrDA RX
88	PD7	LED1
89	PB3	Debug TDO
90	PB4	Debug TRST
91	PB5	ETHER_PPS_OUT / CAN2_RX
92	PB6	E2P_SCL / Audio_SCL / IO_SCL / MemS_SCL / CAN2_TX
93	PB7	E2P_SDA / Audio_SDA / IO_SCL / MemS_SDA
94	BOOT0	BOOT0
95	PB8	ETHER_TXD3
96	PB9	User Button
97	PE0	MC_TIM3_ETR pin 27 (PFC SYNC2) / microSD_Card_Detect
98	PE1	OTG_Overcurrent
99	VSS_3	GND
100	VDD_3	+3V3

## Revision history

**Table 28. Document revision history**

Date	Revision	Changes
26-Feb-2009	1	Initial release.
19-Jun-2009	2	Update for PCB rev.B

**Please Read Carefully:**

Information in this document is provided solely in connection with ST products. STMicroelectronics NV and its subsidiaries ("ST") reserve the right to make changes, corrections, modifications or improvements, to this document, and the products and services described herein at any time, without notice.

All ST products are sold pursuant to ST's terms and conditions of sale.

Purchasers are solely responsible for the choice, selection and use of the ST products and services described herein, and ST assumes no liability whatsoever relating to the choice, selection or use of the ST products and services described herein.

No license, express or implied, by estoppel or otherwise, to any intellectual property rights is granted under this document. If any part of this document refers to any third party products or services it shall not be deemed a license grant by ST for the use of such third party products or services, or any intellectual property contained therein or considered as a warranty covering the use in any manner whatsoever of such third party products or services or any intellectual property contained therein.

**UNLESS OTHERWISE SET FORTH IN ST'S TERMS AND CONDITIONS OF SALE ST DISCLAIMS ANY EXPRESS OR IMPLIED WARRANTY WITH RESPECT TO THE USE AND/OR SALE OF ST PRODUCTS INCLUDING WITHOUT LIMITATION IMPLIED WARRANTIES OF MERCHANTABILITY, FITNESS FOR A PARTICULAR PURPOSE (AND THEIR EQUIVALENTS UNDER THE LAWS OF ANY JURISDICTION), OR INFRINGEMENT OF ANY PATENT, COPYRIGHT OR OTHER INTELLECTUAL PROPERTY RIGHT.**

**UNLESS EXPRESSLY APPROVED IN WRITING BY AN AUTHORIZED ST REPRESENTATIVE, ST PRODUCTS ARE NOT RECOMMENDED, AUTHORIZED OR WARRANTED FOR USE IN MILITARY, AIR CRAFT, SPACE, LIFE SAVING, OR LIFE SUSTAINING APPLICATIONS, NOR IN PRODUCTS OR SYSTEMS WHERE FAILURE OR MALFUNCTION MAY RESULT IN PERSONAL INJURY, DEATH, OR SEVERE PROPERTY OR ENVIRONMENTAL DAMAGE. ST PRODUCTS WHICH ARE NOT SPECIFIED AS "AUTOMOTIVE GRADE" MAY ONLY BE USED IN AUTOMOTIVE APPLICATIONS AT USER'S OWN RISK.**

Resale of ST products with provisions different from the statements and/or technical features set forth in this document shall immediately void any warranty granted by ST for the ST product or service described herein and shall not create or extend in any manner whatsoever, any liability of ST.

ST and the ST logo are trademarks or registered trademarks of ST in various countries.

Information in this document supersedes and replaces all information previously supplied.

The ST logo is a registered trademark of STMicroelectronics. All other names are the property of their respective owners.

© 2009 STMicroelectronics - All rights reserved

STMicroelectronics group of companies

Australia - Belgium - Brazil - Canada - China - Czech Republic - Finland - France - Germany - Hong Kong - India - Israel - Italy - Japan - Malaysia - Malta - Morocco - Philippines - Singapore - Spain - Sweden - Switzerland - United Kingdom - United States of America

[www.st.com](http://www.st.com)