

# FDG901D

## Slew Rate Control Driver IC for P-Channel MOSFETs

### General Description

The FDG901D is specifically designed to control the turn on of a P-Channel MOSFET in order to limit the inrush current in battery switching applications with high capacitance loads. During turn-on the FDG901D drives the MOSFET's gate low with a regulated current source, thereby controlling the MOSFET's turn on. For turn-off, the IC pulls the MOSFET gate up quickly, for efficient turn off.

### Features

- Three Programmable slew rates
- Reduces inrush current
- Minimizes EMI
- Normal turn-off speed
- Low-Power CMOS operates over wide voltage range
- Compact industry standard SC70-5 surface mount package

### Applications

- Power management
- Battery Load switch

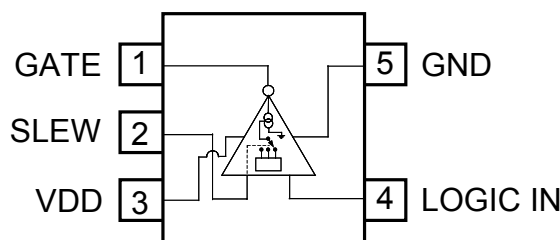
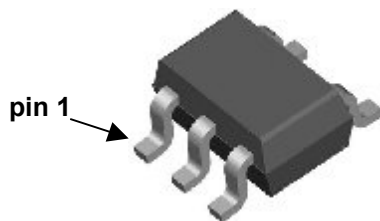

### Absolute Maximum Ratings T<sub>A</sub>=25°C unless otherwise noted

Symbol	Parameter	Ratings	Units
V <sub>DD</sub>	Supply Voltage	-0.5 to 10	V
V <sub>IN</sub>	DC Input Voltage (Logic Inputs)	-0.7 to 6	V
P <sub>D</sub>	Power Dissipation for Single Operation @ 85°C	150	mW
T <sub>J</sub> , T <sub>STG</sub>	Operating and Storage Junction Temperature Range	-65 to +150	°C

### Recommended Operating Range

V <sub>DD</sub>	Supply Voltage	2.7 to 6.0	V
T <sub>J</sub>	Operating Temperature	-40 to +125	°C

### Thermal Characteristics

R <sub>θJA</sub>	Thermal Resistance, Junction-to-Ambient (Note 1)	425	°C/W
------------------	--	-----	------

### Package Marking and Ordering Information

Device Marking	Device	Reel Size	Tape width	Quantity
91	FDG901D	7"	8mm	3000 units

### Electrical Characteristics

$T_A = 25^\circ\text{C}$  unless otherwise noted

Symbol	Parameter	Test Conditions	Min	Typ	Max	Units
<b>Logic Levels</b>						
$V_{IH}$	Logic HIGH Input Voltage	$V_{DD} = 2.70\text{V to } 6.0\text{ V}$	75% of $V_{DD}$			V
$V_{IL}$	Logic LOW Input Voltage	$V_{DD} = 2.70\text{V to } 6.0\text{ V}$			25% of $V_{DD}$	V
<b>OFF Characteristics</b>						
$BV_{IN}$	Logic Input Breakdown Voltage	$I_{IN} = 10\mu\text{A}, V_{SLEW} = 0\text{ V}$	9			V
$BV_{SLEW}$	Slew Input Breakdown Voltage	$I_{SLEW} = 10\mu\text{A}, V_{IN} = 0\text{ V}$	9			V
$BV_{DG}$	Supply Input Breakdown Voltage	$I_{DG} = 10\mu\text{A}, V_{IN} = 0\text{ V}, V_{SLEW} = 0\text{ V}$	9			V
$I_{RIN}$	LOGIC Input Leakage Current	$V_{IN} = 8\text{ V}, V_{SLEW} = 0\text{ V}$			100	nA
$I_{RSLEW}$	SLEW Input Leakage Current	$V_{SLEW} = 8\text{ V}, V_{IN} = 0\text{ V}$			100	nA
$I_{RDG}$	Supply Input Leakage Current	$V_{DG} = 8\text{ V}, V_{IN} = 0\text{ V}, V_{SLEW} = 0\text{ V}$			100	nA

### ON Characteristics

$I_G$	Gate Current	$V_{IN} = 6\text{ V}$ $V_{GATE} = 2\text{ V}$	SLEW = OPEN	90	120	$\mu\text{A}$
			SLEW = GND	1	10	$\mu\text{A}$
			SLEW = $V_{DD}$	10	50	nA

### Switching Characteristics

Symbol	Parameter	Test Conditions	Min	Typ	Max	Units
$t_{don}$	Output Turn-On Delay Time Slew Pin = OPEN	$V_{Supply} = 5.5\text{ V}, V_{DD} = 5.5\text{ V},$ Logic IN = 5.5 V, $C_{LOAD} = 510\text{ pF},$ Test Circuit		8.3		$\mu\text{s}$
$t_{don}$	Output Turn-On Delay Time Slew Pin = GROUND			0.6		ms
$t_{don}$	Output Turn-On Delay Time Slew Pin = VDD			2.2		ms
$t_{rise}$	Output Rise Time Slew Pin = OPEN	$V_{Supply} = 5.5\text{ V}, V_{DD} = 5.5\text{ V},$ Logic IN = 5.5 V, $C_{LOAD} = 510\text{ pF},$ Test Circuit		28		$\mu\text{s}$
$t_{rise}$	Output Rise Time Slew Pin = GROUND			1.8		ms
$t_{rise}$	Output Rise Time Slew Pin = VDD			11		ms
dv/dt	Output Slew Rate Slew Pin = OPEN	$V_{Supply} = 5.5\text{ V}, V_{DD} = 5.5\text{ V},$ Logic IN = 5.5 V, $C_{LOAD} = 510\text{ pF},$ Test Circuit		162		V/ms
dv/dt	Output Slew Rate Slew Pin = GROUND			2.6		V/ms
dv/dt	Output Slew Rate Slew Pin = VDD			0.3		V/ms

**Notes:**  $R_{\theta JA}$  is the sum of the junction-to-case and case-to-ambient thermal resistance where the case thermal reference is defined as the solder mounting surface of the drain pins.  $R_{\theta JC}$  is guaranteed by design while  $R_{\theta CA}$  is determined by the user's board design.

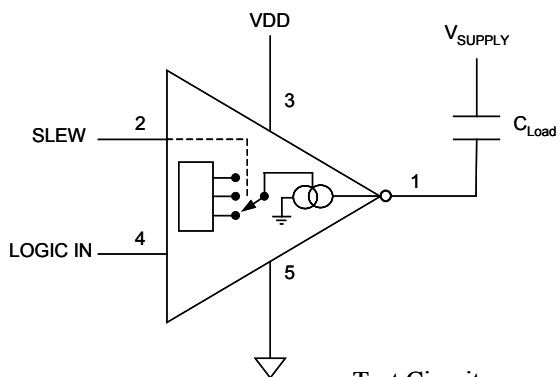

Test Circuit

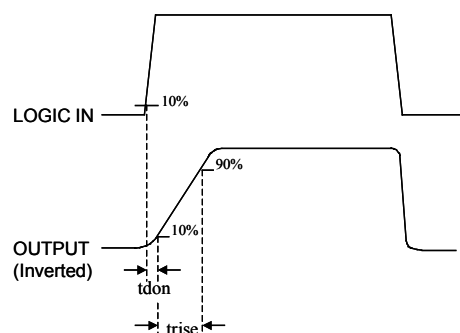

Switching Waveforms

## Typical Characteristics

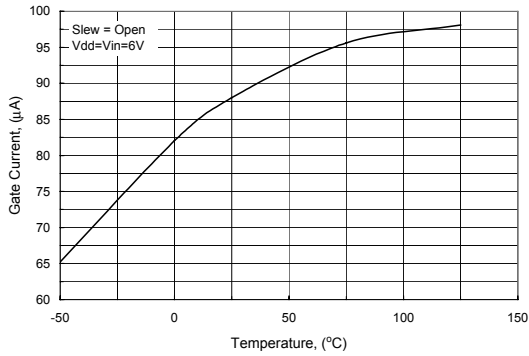

**Figure 1. GATE Output current vs. Temperature. SLEW = OPEN**

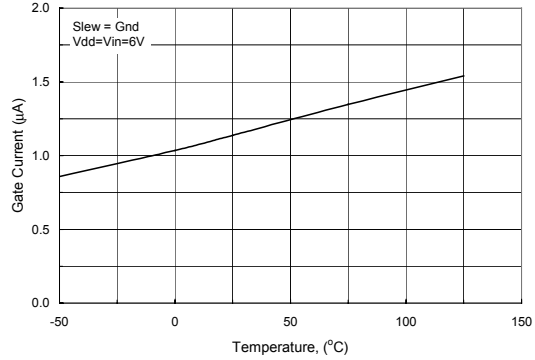

**Figure 2. GATE Output current vs. Temperature. SLEW = Ground**

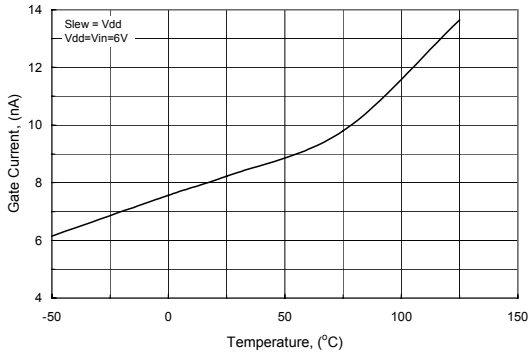

**Figure 3. GATE Output current vs. Temperature. SLEW = V<sub>DD</sub>**

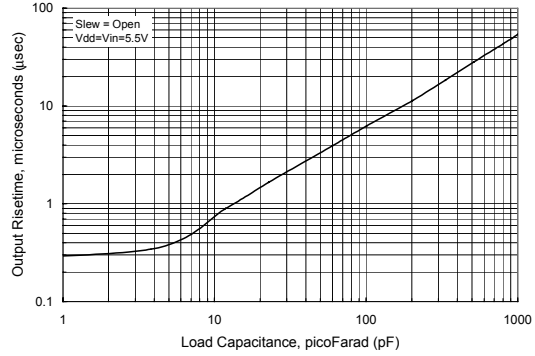

**Figure 4.  $t_{rise}$  vs. Load Capacitance. SLEW = OPEN**

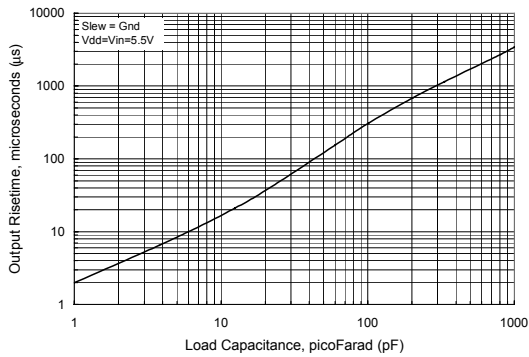

**Figure 5.  $t_{rise}$  vs. Load Capacitance. SLEW = GROUND**

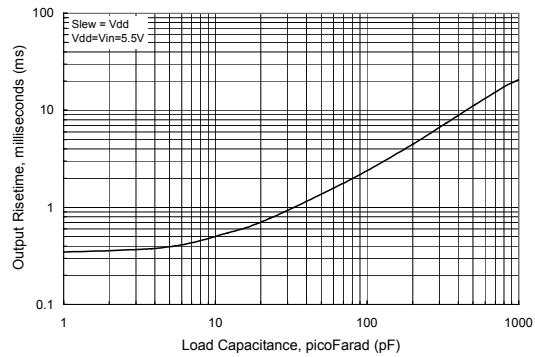

**Figure 6.  $t_{rise}$  vs. Load Capacitance. SLEW = V<sub>DD</sub>**

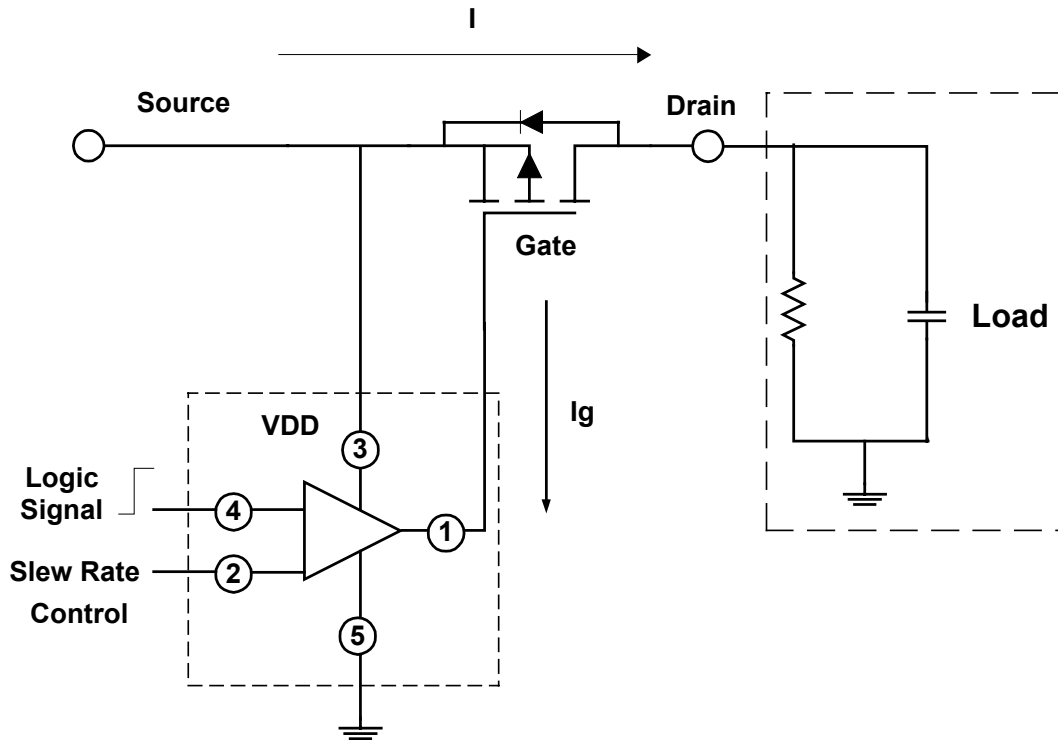

**Application Circuit**

### Typical Application

Battery powered systems make extensive usage of load switching, turning the power to subsystems off, in order to extend battery life. Power MOSFETs are used to accomplish this task. In PDA's and Cell phones, these MOSFETs are usually low threshold P-Channels. Since the loads typically include bypass capacitor components (high capacitive component), a high inrush current can occur when the load is switched on. This inrush current can cause transients on the main power supply disturbing circuitry supplied by it.

The simplest method of limiting the inrush current is to control the slew rate of the MOSFET switch. This can be done with external R/C circuits, but this approach can occupy significant PCB area, and involves other compromises in performance. The slew rate control driver IC FDG901D is specifically designed to interface low voltage digital circuitry with power MOSFETs and reduce the rapid inrush current in load switch applications. The IC limits inrush current by controlling the current, which drives the gate of the P-Channel MOSFET switch.

The control input is a CMOS compatible input with a minimum high input voltage of 2.55V with a power rail voltage of 6V. Therefore, it is compatible with any CMOS logic voltages between 2.55V and 5V and under these conditions there is no additional configuration required.

The Slew Rate Control Driver (FDG901D) is designed to give a programmed choice of one of three steady  $dv/dt$  states on the output during turn-on. To change the  $dv/dt$  value, the user needs to use the Slew Rate Control Pin (Pin 2). To utilize the smallest current setting ( $\approx 10$  nA) from the IC, a voltage equal to  $V_{DD}$  must be applied to the Slew Rate Control Pin 2. To use the next higher current setting ( $\approx 1$   $\mu$ A) a voltage equal to Ground must be applied to Pin 2. To achieve the highest current setting ( $\approx 80$   $\mu$ A) or obtain a faster switching speed, the Slew Rate Pin2 must be open (floating). A higher value of capacitance will result in a slower switching rate. To determine the switching times of each setting use the simple equation:

$$t = \frac{Q_g}{I_G}$$

where  $Q_g$  is the Gate charge in nC for a given MOSFET and  $I_G$  is the gate current controlled by the slew rate pin.

Below is a captured image from an oscilloscope depicting the device response. The FDG901D was connected to control an FDG258P P-Channel DMOS. The Slew Rate control pin was set to open (floating state).

Test Conditions:

$$V_{DD} = 5.5V$$

$$V_{IN} = 5.5V$$

$$R_{LOAD} = 1.5\Omega$$

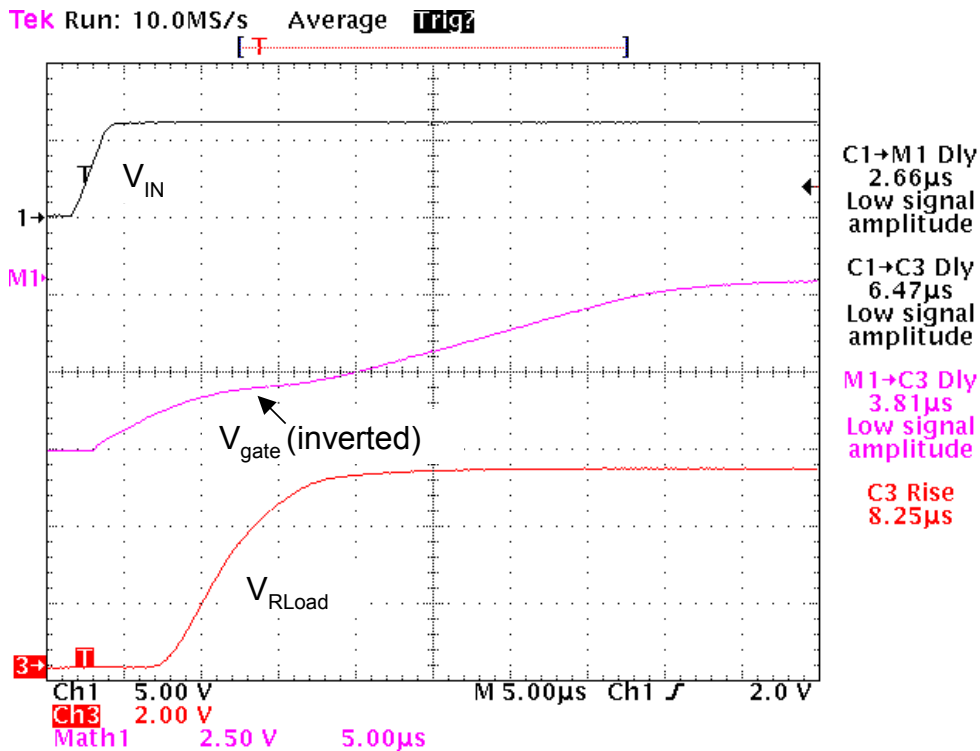

Circuit waveforms for an FDG901D controlling a P-Channel FDG258P MOSFET.

## TRADEMARKS

The following are registered and unregistered trademarks Fairchild Semiconductor owns or is authorized to use and is not intended to be an exhaustive list of all such trademarks.

ACE <sub>x</sub> <sup>™</sup>	FAST <sup>®</sup>	MICROWIRE <sup>™</sup>	SILENT SWITCHER <sup>®</sup>	UHC <sup>™</sup>
Bottomless <sup>™</sup>	FAST <sub>r</sub> <sup>™</sup>	OPTOLOGIC <sup>®</sup>	SMART START <sup>™</sup>	UltraFET <sup>®</sup>
CoolFET <sup>™</sup>	FRFET <sup>™</sup>	OPTOPLANAR <sup>™</sup>	SPM <sup>™</sup>	VCX <sup>™</sup>
CROSSVOLT <sup>™</sup>	GlobalOptoisolator <sup>™</sup>	PACMAN <sup>™</sup>	STAR*POWER <sup>™</sup>	
DenseTrench <sup>™</sup>	GTO <sup>™</sup>	POP <sup>™</sup>	Stealth <sup>™</sup>	
DOME <sup>™</sup>	HiSeC <sup>™</sup>	Power247 <sup>™</sup>	SuperSOT <sup>™</sup> -3	
EcoSPARK <sup>™</sup>	I <sup>2</sup> C <sup>™</sup>	PowerTrench <sup>®</sup>	SuperSOT <sup>™</sup> -6	
E <sup>2</sup> CMOS <sup>™</sup>	ISOPLANAR <sup>™</sup>	QFET <sup>™</sup>	SuperSOT <sup>™</sup> -8	
EnSigna <sup>™</sup>	LittleFET <sup>™</sup>	QS <sup>™</sup>	SyncFET <sup>™</sup>	
FACT <sup>™</sup>	MicroFET <sup>™</sup>	QT Optoelectronics <sup>™</sup>	TinyLogic <sup>™</sup>	
FACT Quiet Series <sup>™</sup>	MicroPak <sup>™</sup>	Quiet Series <sup>™</sup>	TruTranslation <sup>™</sup>	

STAR\*POWER is used under license

## DISCLAIMER

FAIRCHILD SEMICONDUCTOR RESERVES THE RIGHT TO MAKE CHANGES WITHOUT FURTHER NOTICE TO ANY PRODUCTS HEREIN TO IMPROVE RELIABILITY, FUNCTION OR DESIGN. FAIRCHILD DOES NOT ASSUME ANY LIABILITY ARISING OUT OF THE APPLICATION OR USE OF ANY PRODUCT OR CIRCUIT DESCRIBED HEREIN; NEITHER DOES IT CONVEY ANY LICENSE UNDER ITS PATENT RIGHTS, NOR THE RIGHTS OF OTHERS.

## LIFE SUPPORT POLICY

FAIRCHILD'S PRODUCTS ARE NOT AUTHORIZED FOR USE AS CRITICAL COMPONENTS IN LIFE SUPPORT DEVICES OR SYSTEMS WITHOUT THE EXPRESS WRITTEN APPROVAL OF FAIRCHILD SEMICONDUCTOR CORPORATION. As used herein:

1. Life support devices or systems are devices or systems which, (a) are intended for surgical implant into the body, or (b) support or sustain life, or (c) whose failure to perform when properly used in accordance with instructions for use provided in the labeling, can be reasonably expected to result in significant injury to the user.
2. A critical component is any component of a life support device or system whose failure to perform can be reasonably expected to cause the failure of the life support device or system, or to affect its safety or effectiveness.

## PRODUCT STATUS DEFINITIONS

### Definition of Terms

Datasheet Identification	Product Status	Definition
Advance Information	Formative or In Design	This datasheet contains the design specifications for product development. Specifications may change in any manner without notice.
Preliminary	First Production	This datasheet contains preliminary data, and supplementary data will be published at a later date. Fairchild Semiconductor reserves the right to make changes at any time without notice in order to improve design.
No Identification Needed	Full Production	This datasheet contains final specifications. Fairchild Semiconductor reserves the right to make changes at any time without notice in order to improve design.
Obsolete	Not In Production	This datasheet contains specifications on a product that has been discontinued by Fairchild semiconductor. The datasheet is printed for reference information only.