



# FGPF30N30

## 300V, 30A PDP IGBT

### Features

- High Current Capability
- Low saturation voltage:  $V_{CE(sat)} = 1.4V @ I_C = 20A$
- High Input Impedance
- Fast switching
- RoHS Compliant

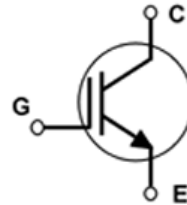
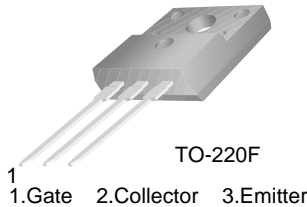


### General Description

Employing Unified IGBT Technology, Fairchild's PDP IGBTs provides low conduction and switching loss. FGPF30N30 offers the optimum solution for PDP applications where low-conduction loss is essential.

### Application

- PDP System



### Absolute Maximum Ratings

Symbol	Description	FGPF30N30	Units
$V_{CES}$	Collector-Emitter Voltage	300	V
$V_{GES}$	Gate-Emitter Voltage	$\pm 30$	V
$I_C$ pulse(1)	Pulsed Collector Current @ $T_C = 25^\circ C$	80	A
$P_D$	Maximum Power Dissipation @ $T_C = 25^\circ C$	46	W
	Maximum Power Dissipation @ $T_C = 100^\circ C$	18.5	W
$T_J$	Operating Junction Temperature	-55 to +150	$^\circ C$
$T_{stg}$	Storage Temperature Range	-55 to +150	$^\circ C$
$T_L$	Maximum Lead Temp. for soldering Purposes, 1/8" from case for 5 seconds	300	$^\circ C$

### Thermal Characteristics

Symbol	Parameter	Typ.	Max.	Units
$R_{\theta JC}$ (IGBT)	Thermal Resistance, Junction-to-Case	--	2.7	$^\circ C/W$
$R_{\theta JA}$	Thermal Resistance, Junction-to-Ambient	--	62.5	$^\circ C/W$

**Notes:**

(1) Repetitive test, pulse width = 100usec, Duty = 0.1

\*  $I_{c\_pulse}$  limited by max  $T_J$

### Package Marking and Ordering Information

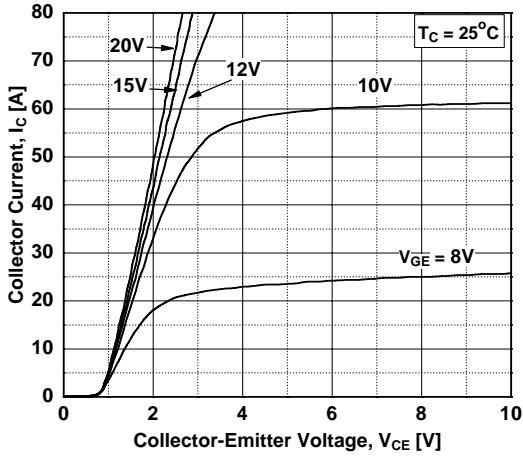
Device Marking	Device	Package	Packaging Type	Qty per Tube	Max Qty per Box
FGPF30N30	FGFP30N30TU	TO-220F	Rail / Tube	50ea	-

### Electrical Characteristics T<sub>C</sub> = 25°C unless otherwise noted

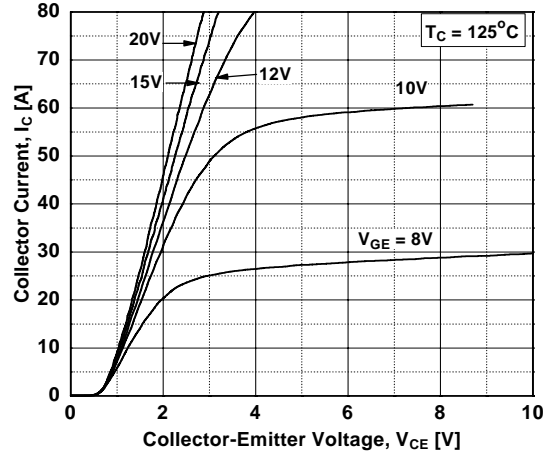
Symbol	Parameter	Test Conditions	Min.	Typ.	Max.	Units
<b>Off Characteristics</b>						
BV <sub>CES</sub>	Collector-Emitter Breakdown Voltage	V <sub>GE</sub> = 0V, I <sub>C</sub> = 250uA	300	--	--	V
$\frac{\Delta BV_{CES}}{\Delta T_J}$	Temperature Coefficient of Breakdown Voltage	V <sub>GE</sub> = 0V, I <sub>C</sub> = 250uA	--	0.6	--	V/°C
I <sub>CES</sub>	Collector Cut-Off Current	V <sub>CE</sub> = V <sub>CES</sub> , V <sub>GE</sub> = 0V	--	--	100	uA
I <sub>GES</sub>	G-E Leakage Current	V <sub>GE</sub> = V <sub>GES</sub> , V <sub>CE</sub> = 0V	--	--	± 250	nA
<b>On Characteristics</b>						
V <sub>GE(th)</sub>	G-E Threshold Voltage	I <sub>C</sub> = 250uA, V <sub>CE</sub> = V <sub>GE</sub>	2.5	4.0	5.0	V
V <sub>CE(sat)</sub>	Collector to Emitter Saturation Voltage	I <sub>C</sub> = 10A, V <sub>GE</sub> = 15V	--	1.2	1.5	V
		I <sub>C</sub> = 20A, V <sub>GE</sub> = 15V	--	1.4	--	V
		I <sub>C</sub> = 30A, V <sub>GE</sub> = 15V T <sub>C</sub> = 25°C	--	1.8	--	V
		I <sub>C</sub> = 30A, V <sub>GE</sub> = 15V T <sub>C</sub> = 125°C	--	1.9	--	V
<b>Dynamic Characteristics</b>						
C <sub>ies</sub>	Input Capacitance	V <sub>CE</sub> = 30V, V <sub>GE</sub> = 0V f = 1MHz	--	685	--	pF
C <sub>oes</sub>	Output Capacitance		--	95	--	pF
C <sub>res</sub>	Reverse Transfer Capacitance		--	30	--	pF
<b>Switching Characteristics</b>						
t <sub>d(on)</sub>	Turn-On Delay Time	V <sub>CC</sub> = 200 V, I <sub>C</sub> = 20A R <sub>G</sub> = 20Ω, V <sub>GE</sub> = 15V Resistive Load, T <sub>C</sub> = 25°C	--	10	--	ns
t <sub>r</sub>	Rise Time		--	44	--	ns
t <sub>d(off)</sub>	Turn-Off Delay Time		--	76	--	ns
t <sub>f</sub>	Fall Time		--	180	300	ns
t <sub>d(on)</sub>	Turn-On Delay Time	V <sub>CC</sub> = 200 V, I <sub>C</sub> = 20A R <sub>G</sub> = 20Ω, V <sub>GE</sub> = 15V Resistive Load, T <sub>C</sub> = 125°C	--	10	-	ns
t <sub>r</sub>	Rise Time		--	46	--	ns
t <sub>d(off)</sub>	Turn-Off Delay Time		--	82	--	ns
t <sub>f</sub>	Fall Time		--	270	--	ns
Q <sub>g</sub>	Total Gate Charge	V <sub>CE</sub> = 200 V, I <sub>C</sub> = 20A V <sub>GE</sub> = 15V	--	39	--	nC
Q <sub>ge</sub>	Gate-Emitter Charge		--	6	--	nC
Q <sub>gc</sub>	Gate-Collector Charge		--	16	--	nC

**Typical Performance Characteristics**

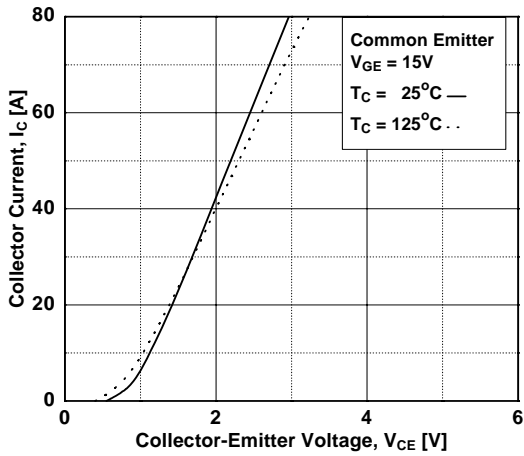
**Figure 1. Typical Output Characteristics**



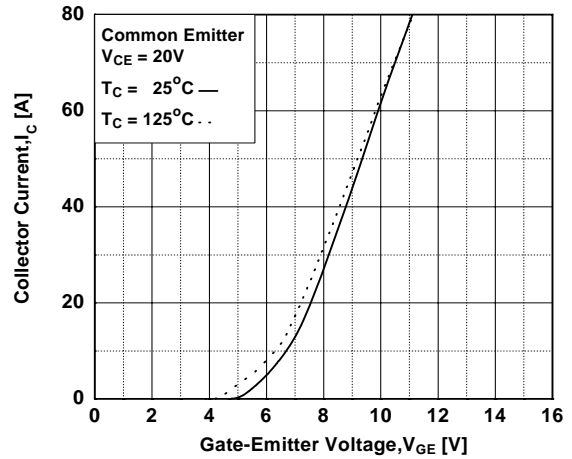
**Figure 2. Typical Output Characteristics**



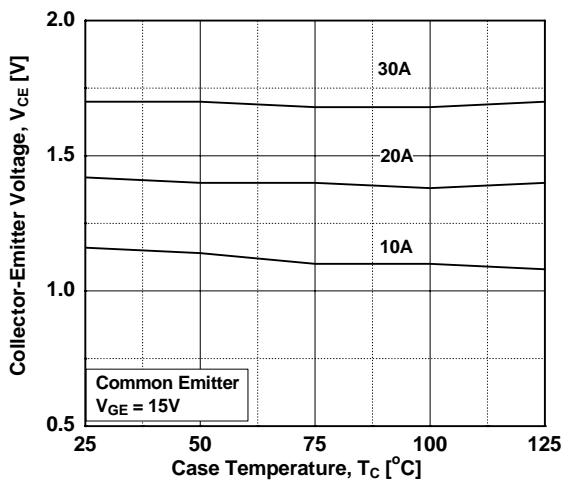
**Figure 3. Saturation Voltage**



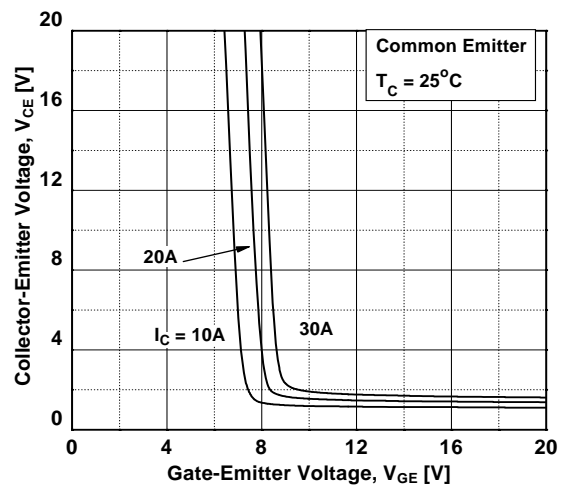
**Figure 4. Transfer Characteristics**



**Figure 5. Saturation Voltage vs. Case Temperature at Variant Current Level**

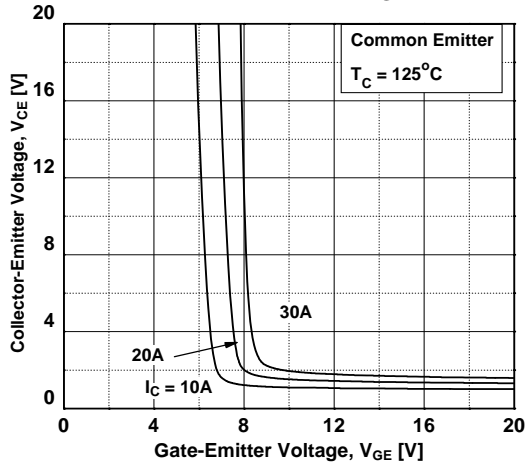


**Figure 6. Saturation Voltage vs.  $V_{GE}$**

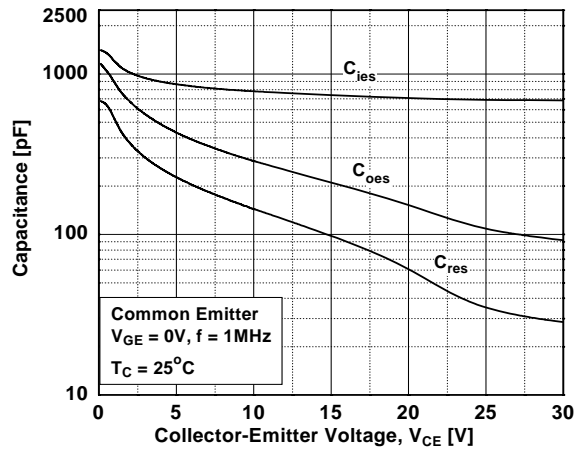


**Typical Performance Characteristics** (Continued)

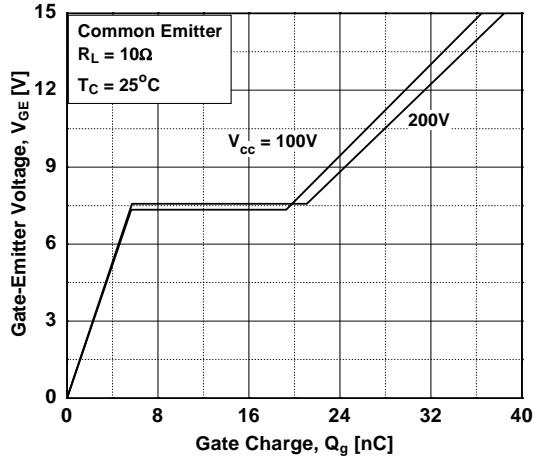
**Figure 7. Saturation Voltage vs.  $V_{GE}$**



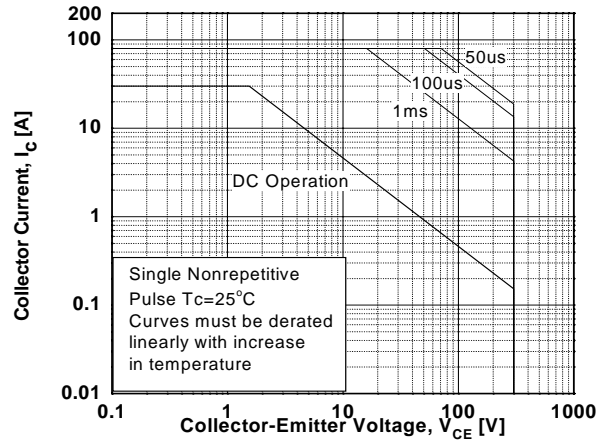
**Figure 8. Capacitance Characteristics**



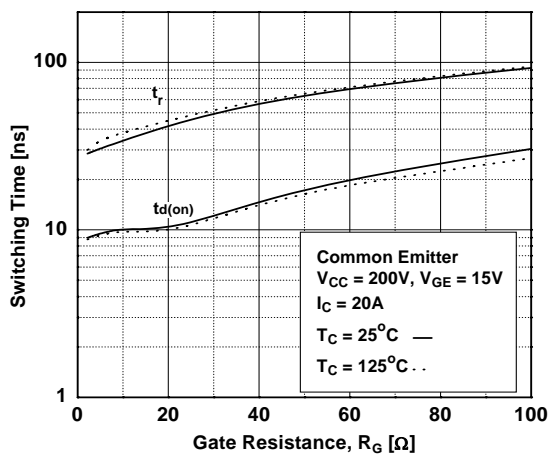
**Figure 9. Gate Charge Characteristics**



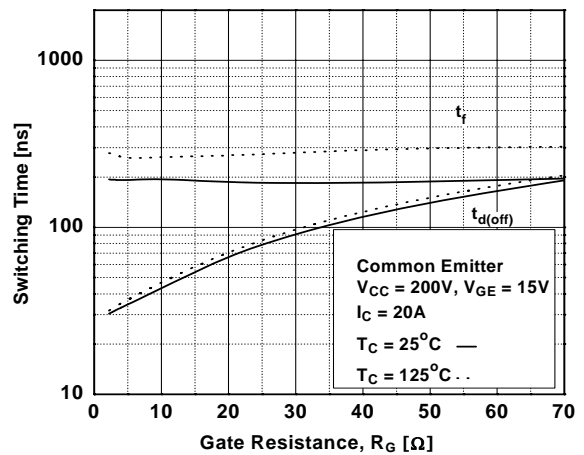
**Figure 10. SOA Characteristics**



**Figure 11. Turn-On Characteristics vs. Gate Resistance**

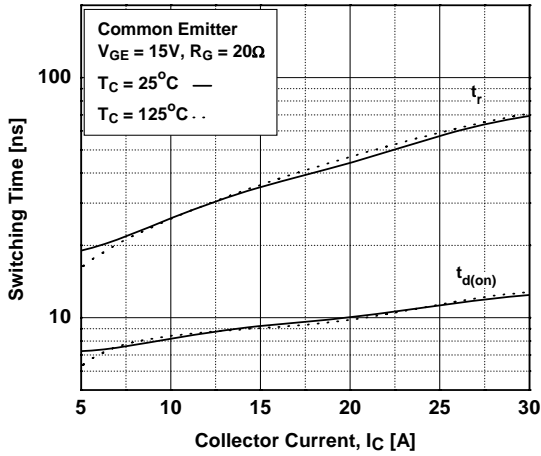


**Figure 12. Turn Off Characteristics vs. Gate Resistance**

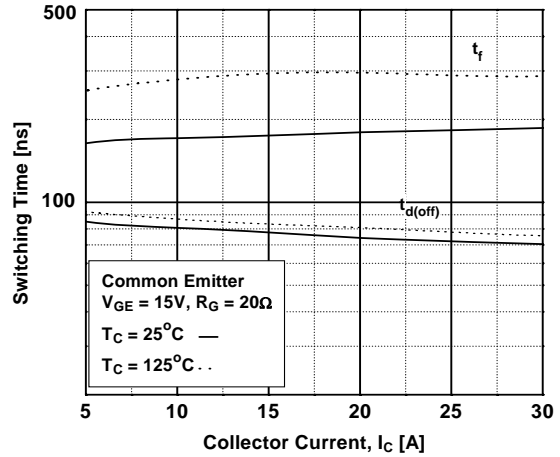


**Typical Performance Characteristics** (Continued)

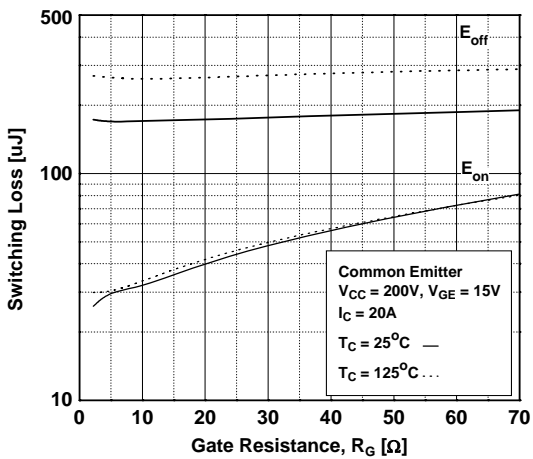
**Figure 13. Turn-On Characteristics vs. Collector Current**



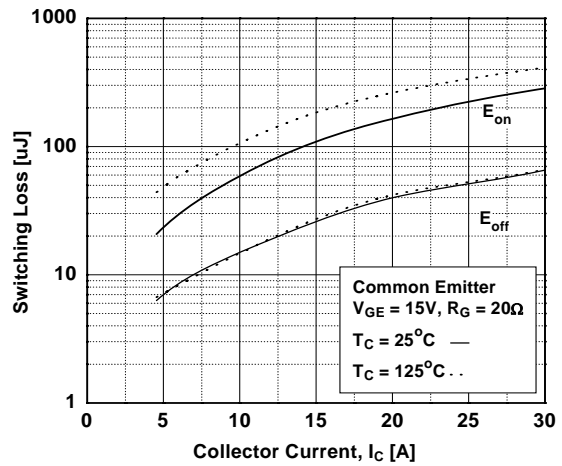
**Figure 14. Turn-Off Characteristics vs. Collector Current**



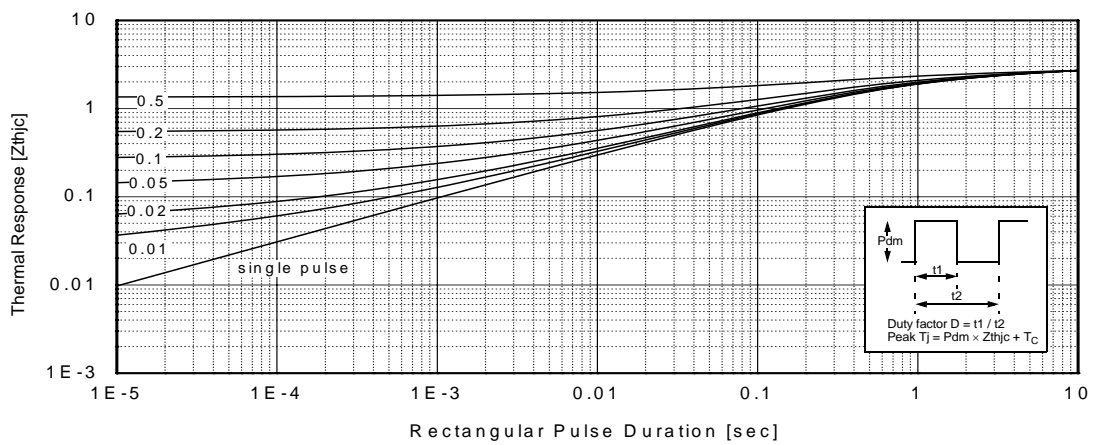
**Figure 15. Switching Loss vs Gate Resistance**



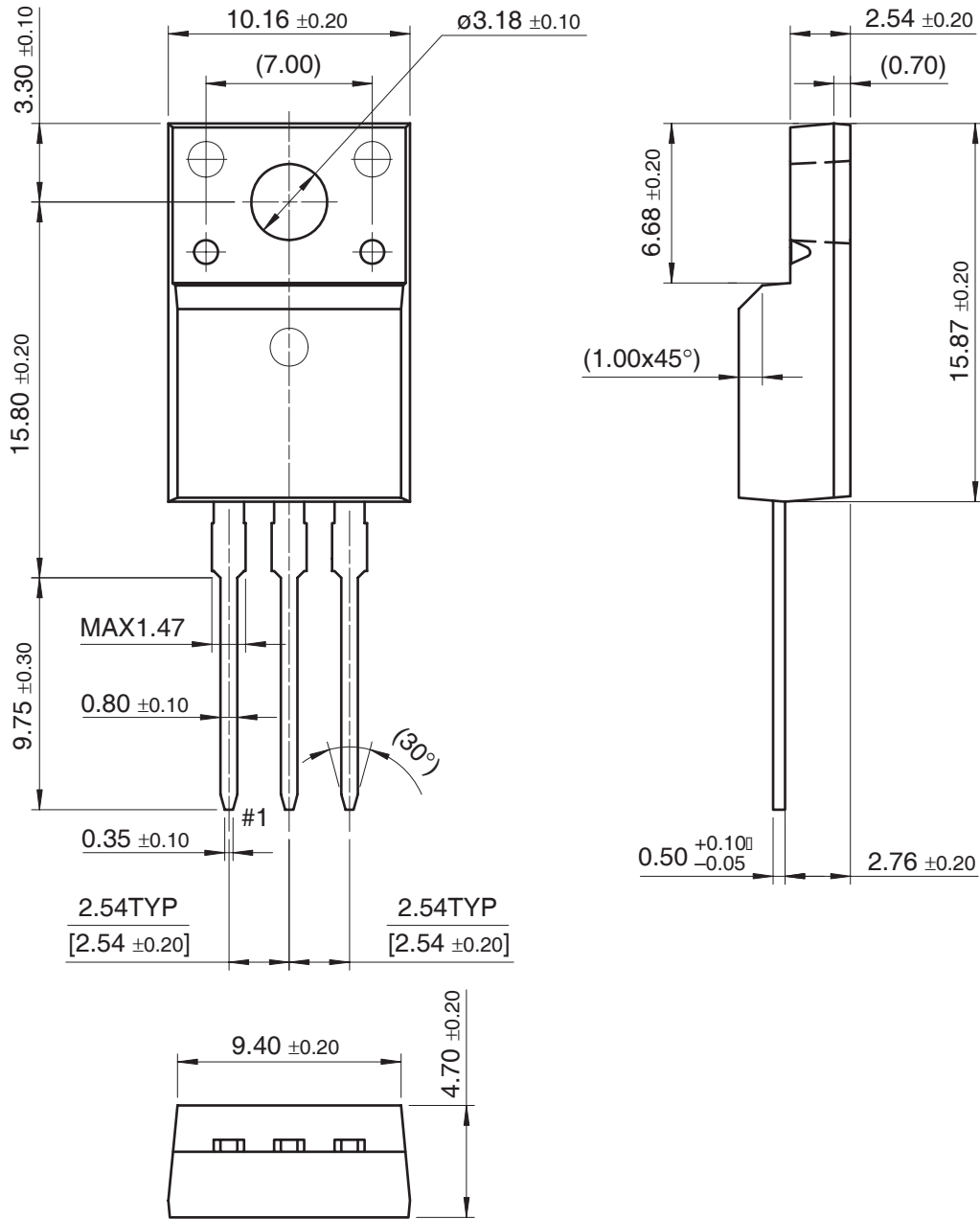
**Figure 16. Switching Loss vs Collector Current**



**Figure 17. Transient Thermal Impedance of IGBT**



TO-220F



**TRADEMARKS**

The following are registered and unregistered trademarks Fairchild Semiconductor owns or is authorized to use and is not intended to be an exhaustive list of all such trademarks.

ACE <sup>x</sup> <sup>TM</sup>	FACT Quiet Series <sup>TM</sup>	OCX <sup>TM</sup>	SILENT SWITCHER <sup>®</sup>	UniFET <sup>TM</sup>
ActiveArray <sup>TM</sup>	GlobalOptoisolator <sup>TM</sup>	OCXPro <sup>TM</sup>	SMART START <sup>TM</sup>	UltraFET <sup>®</sup>
Bottomless <sup>TM</sup>	GTO <sup>TM</sup>	OPTOLOGIC <sup>®</sup>	SPM <sup>TM</sup>	VCX <sup>TM</sup>
Build it Now <sup>TM</sup>	HiSeC <sup>TM</sup>	OPTOPLANAR <sup>TM</sup>	Stealth <sup>TM</sup>	Wire <sup>TM</sup>
CoolFET <sup>TM</sup>	I <sup>2</sup> C <sup>TM</sup>	PACMAN <sup>TM</sup>	SuperFET <sup>TM</sup>	
CROSSVOLT <sup>TM</sup>	i-Lo <sup>TM</sup>	POPT <sup>TM</sup>	SuperSOT <sup>TM</sup> -3	
DOMET <sup>TM</sup>	ImpliedDisconnect <sup>TM</sup>	Power247 <sup>TM</sup>	SuperSOT <sup>TM</sup> -6	
EcoSPARK <sup>TM</sup>	IntelliMAX <sup>TM</sup>	PowerEdge <sup>TM</sup>	SuperSOT <sup>TM</sup> -8	
E <sup>2</sup> CMOS <sup>TM</sup>	ISOPLANAR <sup>TM</sup>	PowerSaver <sup>TM</sup>	SyncFET <sup>TM</sup>	
EnSigna <sup>TM</sup>	LittleFET <sup>TM</sup>	PowerTrench <sup>®</sup>	TCM <sup>TM</sup>	
FACT <sup>TM</sup>	MICROCOUPLER <sup>TM</sup>	QFET <sup>®</sup>	TinyBoost <sup>TM</sup>	
FAST <sup>®</sup>	MicroFET <sup>TM</sup>	QS <sup>TM</sup>	TinyBuck <sup>TM</sup>	
FAST <sub>r</sub> <sup>TM</sup>	MicroPak <sup>TM</sup>	QT Optoelectronics <sup>TM</sup>	TinyPWM <sup>TM</sup>	
FPS <sup>TM</sup>	MICROWIRE <sup>TM</sup>	Quiet Series <sup>TM</sup>	TinyPower <sup>TM</sup>	
FRFET <sup>TM</sup>	MSX <sup>TM</sup>	RapidConfigure <sup>TM</sup>	TinyLogic <sup>®</sup>	
	MSXPro <sup>TM</sup>	RapidConnect <sup>TM</sup>	TINYOPTO <sup>TM</sup>	
Across the board. Around the world. <sup>TM</sup>		μSerDes <sup>TM</sup>	TruTranslation <sup>TM</sup>	
The Power Franchise <sup>®</sup>		ScalarPump <sup>TM</sup>	UHC <sup>TM</sup>	
Programmable Active Droop <sup>TM</sup>				

**DISCLAIMER**

FAIRCHILD SEMICONDUCTOR RESERVES THE RIGHT TO MAKE CHANGES WITHOUT FURTHER NOTICE TO ANY PRODUCTS HEREIN TO IMPROVE RELIABILITY, FUNCTION OR DESIGN. FAIRCHILD DOES NOT ASSUME ANY LIABILITY ARISING OUT OF THE APPLICATION OR USE OF ANY PRODUCT OR CIRCUIT DESCRIBED HEREIN; NEITHER DOES IT CONVEY ANY LICENSE UNDER ITS PATENT RIGHTS, NOR THE RIGHTS OF OTHERS. THESE SPECIFICATIONS DO NOT EXPAND THE TERMS OF FAIRCHILD'S WORLDWIDE TERMS AND CONDITIONS, SPECIFICALLY THE WARRANTY THEREIN, WHICH COVERS THESE PRODUCTS.

**LIFE SUPPORT POLICY**

FAIRCHILD'S PRODUCTS ARE NOT AUTHORIZED FOR USE AS CRITICAL COMPONENTS IN LIFE SUPPORT DEVICES OR SYSTEMS WITHOUT THE EXPRESS WRITTEN APPROVAL OF FAIRCHILD SEMICONDUCTOR CORPORATION.

As used herein:

1. Life support devices or systems are devices or systems which, (a) are intended for surgical implant into the body, or (b) support or sustain life, or (c) whose failure to perform when properly used in accordance with instructions for use provided in the labeling, can be reasonably expected to result in significant injury to the user.
2. A critical component is any component of a life support device or system whose failure to perform can be reasonably expected to cause the failure of the life support device or system, or to affect its safety or effectiveness.

**PRODUCT STATUS DEFINITIONS**

**Definition of Terms**

Datasheet Identification	Product Status	Definition
Advance Information	Formative or In Design	This datasheet contains the design specifications for product development. Specifications may change in any manner without notice.
Preliminary	First Production	This datasheet contains preliminary data, and supplementary data will be published at a later date. Fairchild Semiconductor reserves the right to make changes at any time without notice in order to improve design.
No Identification Needed	Full Production	This datasheet contains final specifications. Fairchild Semiconductor reserves the right to make changes at any time without notice in order to improve design.
Obsolete	Not In Production	This datasheet contains specifications on a product that has been discontinued by Fairchild semiconductor. The datasheet is printed for reference information only.

Rev. I20