

Data sheet

Commercial Art.No.: 25.380.3353.0

PCB connector 8413 B / 3 OB

PCB female connector with screw connection with rising cage clamp system, 3 poles, max. cross section: 2.5 mm², pitch: 7.62 mm, type of packing: carton, color: grey

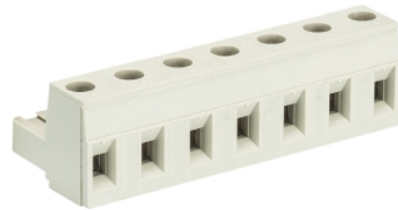

Commercial Art.No.	25.380.3353.0
EAN	4015573198548
Order Unit	100

Certificates / Approvals



Technical data

General

Modular spacing	7.62 mm
Connection type	screw connection
Soldering process	None
Packaging	Carton
Number of poles	3
Marking	No
Fastening	None
Mating direction towards connector	180°

Technical data

Nominal cross section	2.5 mm ²
Rated current	12 A
Overvoltage Category I	1000 V
Overvoltage Category II	690 V
Overvoltage Category III	400 V
Rated impulse voltage	4 kV
Wire strip length	6 mm

Connection Data

Minimum cross section solid	0.14 mm ²
Maximum cross section solid	2.5 mm ²
Minimum cross section fine stranded	0.14 mm ²
Maximum cross section fine stranded	2.5 mm ²
Wire strip length	6 mm

Technical Data UL/CSA

Cross section UL	22-12 AWG
Voltage UL	300 V
Current field wiring	15 A

Current factory wiring	15 A
Cross section CSA	22-12 AWG
Voltage CSA	300 V
Current CSA	15 A

Other

Type of insulation material	Thermoplastic
Color	Grey
Height	15 mm
Length	20.74 mm
Depth	18.2 mm
Material attachment screw	CuSn/Steel
Material contact base	CuSn
Material contact surface	Sn

Classification

ECLASS 11	
ECLASS 8.1	27440402
ETIM 7.0	EC002637
ETIM 6.0	EC002637
ETIM 5.0	EC002637
ETIM 4.0	EC002637

Product compliance

ROHS conformity status	Compliant/Exempted
ROHS exceptions	III-6(c)
REACH-SVHC conformity status	Duty-To-Declare
REACH-SVHC substances	Lead
REACH-SVHC CAS numbers	7439-92-1

Fits with

Commercial Art.No.:	Article-type description:	Description:
25.390.3353.0	PCB pin header 8413 S / 3 G OB	PCB pin header with pin header, connection method depends on used socket part , 3 poles, pitch: 7.62 mm, type of packing: carton, color: grey
25.392.3353.0	PCB pin header 8413 S / 3 W OB	PCB pin header with pin header, connection method depends on used socket part , 3 poles, pitch: 7.62 mm, type of packing: carton, color: grey

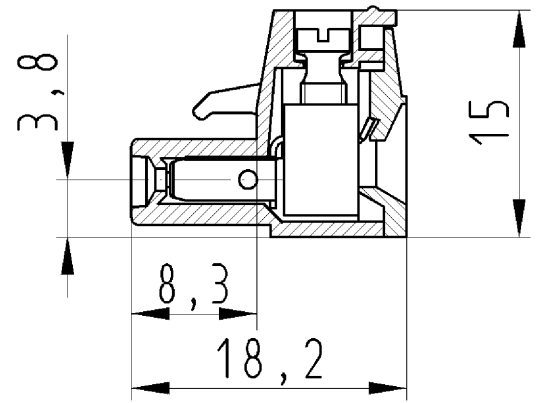
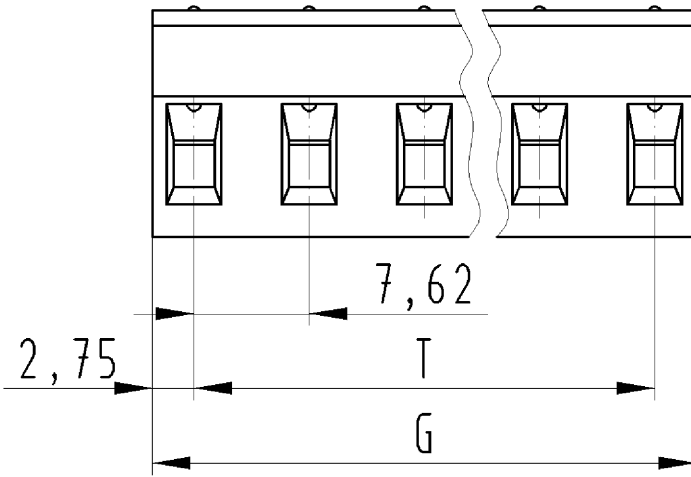

für folgende Tabellen-Zchnng.:
25.380.4253.F 8413 B/... OB

LP.KLEMME
25.380.3253.0 10W
30.10.2007 DÜT
M 2:1