



Is Now Part of



**ON Semiconductor®**

To learn more about ON Semiconductor, please visit our website at  
[www.onsemi.com](http://www.onsemi.com)

Please note: As part of the Fairchild Semiconductor integration, some of the Fairchild orderable part numbers will need to change in order to meet ON Semiconductor's system requirements. Since the ON Semiconductor product management systems do not have the ability to manage part nomenclature that utilizes an underscore (\_), the underscore (\_) in the Fairchild part numbers will be changed to a dash (-). This document may contain device numbers with an underscore (\_). Please check the ON Semiconductor website to verify the updated device numbers. The most current and up-to-date ordering information can be found at [www.onsemi.com](http://www.onsemi.com). Please email any questions regarding the system integration to [Fairchild\\_questions@onsemi.com](mailto:Fairchild_questions@onsemi.com).

ON Semiconductor and the ON Semiconductor logo are trademarks of Semiconductor Components Industries, LLC dba ON Semiconductor or its subsidiaries in the United States and/or other countries. ON Semiconductor owns the rights to a number of patents, trademarks, copyrights, trade secrets, and other intellectual property. A listing of ON Semiconductor's product/patent coverage may be accessed at [www.onsemi.com/site/pdf/Patent-Marking.pdf](http://www.onsemi.com/site/pdf/Patent-Marking.pdf). ON Semiconductor reserves the right to make changes without further notice to any products herein. ON Semiconductor makes no warranty, representation or guarantee regarding the suitability of its products for any particular purpose, nor does ON Semiconductor assume any liability arising out of the application or use of any product or circuit, and specifically disclaims any and all liability, including without limitation special, consequential or incidental damages. Buyer is responsible for its products and applications using ON Semiconductor products, including compliance with all laws, regulations and safety requirements or standards, regardless of any support or applications information provided by ON Semiconductor. "Typical" parameters which may be provided in ON Semiconductor data sheets and/or specifications can and do vary in different applications and actual performance may vary over time. All operating parameters, including "Typicals" must be validated for each customer application by customer's technical experts. ON Semiconductor does not convey any license under its patent rights nor the rights of others. ON Semiconductor products are not designed, intended, or authorized for use as a critical component in life support systems or any FDA Class 3 medical devices or medical devices with a same or similar classification in a foreign jurisdiction or any devices intended for implantation in the human body. Should Buyer purchase or use ON Semiconductor products for any such unintended or unauthorized application, Buyer shall indemnify and hold ON Semiconductor and its officers, employees, subsidiaries, affiliates, and distributors harmless against all claims, costs, damages, and expenses, and reasonable attorney fees arising out of, directly or indirectly, any claim of personal injury or death associated with such unintended or unauthorized use, even if such claim alleges that ON Semiconductor was negligent regarding the design or manufacture of the part. ON Semiconductor is an Equal Opportunity/Affirmative Action Employer. This literature is subject to all applicable copyright laws and is not for resale in any manner.



# FPF2193 / FPF2194 / FPF2195 Full-Function Load Switch with Adjustable Current Limit

## Features

- <1.8 to 5.5 V Input Voltage Range
- Controlled Turn-On
- 0.1 to 1.5 A Adjustable Current Limit
- Under-Voltage Lockout
- Thermal Shutdown
- <2  $\mu$ A Shutdown Current
- Auto Restart
- Fast Current Limit Response Time
- 5  $\mu$ s to Moderate Over Currents
- 30 ns to Hard Shorts
- Fault Blanking
- Reverse Current Blocking

## Applications

- PDAs
- Cell Phones
- Handheld GPS Devices
- Portable Enterprise / Industrial Devices
- Digital Cameras
- Peripheral Ports and Accessories
- Portable Medical Equipment
- Hot Swap Supplies

## Description

The FPF2193, FPF2194, and FPF2195 form a series of load switches that provides full protection to systems and loads that may encounter large current conditions. These devices contain a 55 m $\Omega$  current-limited P-channel MOSFET that can operate over an input voltage range of 1.8 to 5.5 V. Internally, current is prevented from flowing when the MOSFET is off and the output voltage is higher than the input voltage. Switch control is by a logic input (ON) capable of interfacing directly with low-voltage control signals. Each part contains thermal shutdown protection that shuts off the switch to prevent damage to the part when a continuous over-current condition causes excessive heating.

When the switch current reaches the current limit, the parts operate in a constant-current mode to prohibit excessive currents from causing damage. For the FPF2193 and FPF2194, if the constant current condition still persists after 30 ms, the parts shut off the switch and pull the fault signal pin (FLAGB) LOW. The FPF2193 has an auto-restart feature that turns the switch on again after 450 ms if the ON pin is still active. The FPF2194 does not have this auto-restart feature, so the switch remains off until the ON pin is cycled. The FPF2195 does not turn off after a current limit fault, but remains in the constant-current mode indefinitely. The minimum current limit can be set as low as 45 mA.

These parts are available in a space-saving six ball advanced 0.98 x 1.48 mm WLCSP package.

## Ordering Information

| Part Number | Current Limit [mA] | Current Limit Blanking Time [ms] | Auto-Restart Time [ms] | ON Pin Activity | Top Mark |
|-------------|--------------------|----------------------------------|------------------------|-----------------|----------|
| FPF2193     | 100-1500           | 15/30/60                         | 225/450/900            | Active HIGH     | S6       |
| FPF2194     |                    | 15/30/60                         | NA                     |                 | S7       |
| FPF2195     |                    | 0                                | NA                     |                 | S9       |
| FPF2195BUCX | 45-1500            | 0                                | NA                     |                 | SY       |

### Application Diagram

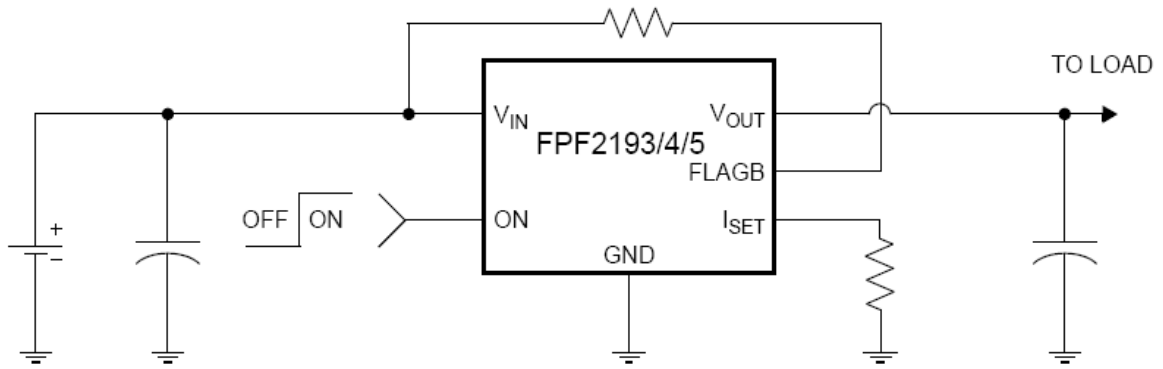

Figure 1. Typical Application

### Block Diagram

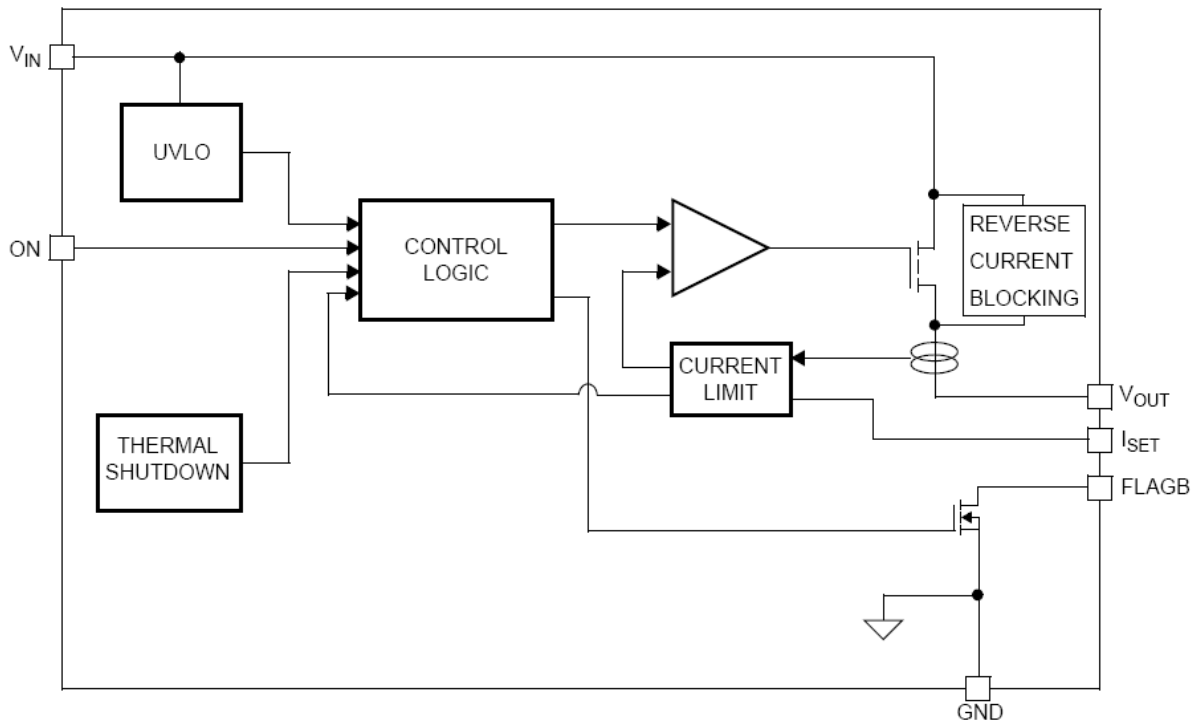

Figure 2. Functional Block Diagram

### Pin Configuration

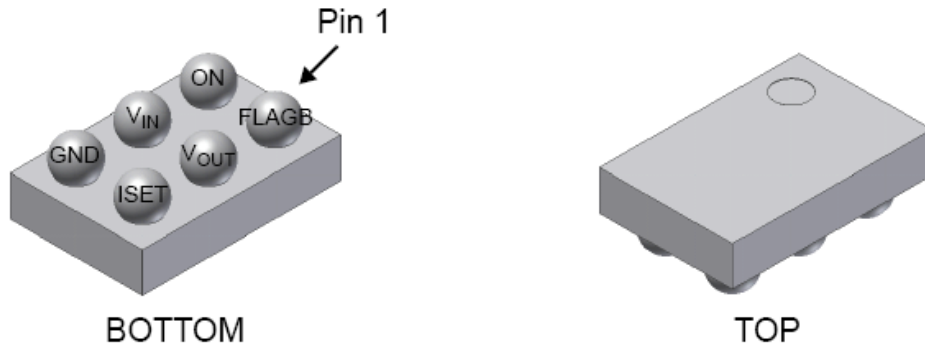

Figure 3. 1.0 x 1.5 mm Chip-Scale Package

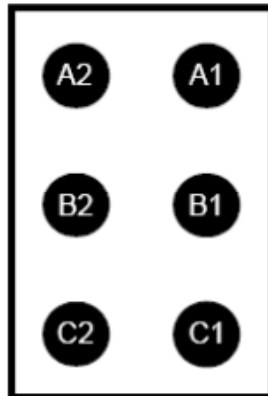

Figure 4. Pin Configuration (Bottom View)

### Pin Definitions

| Pin # | Name             | Description  |
|-------|------------------|--|
| C1    | I <sub>SET</sub> | Current Limit Set Input. A resistor from I <sub>SET</sub> to ground sets the current limit for the switch.                   |
| B2    | V <sub>IN</sub>  | Supply Input. Input to the power switch and the supply voltage for the IC.   |
| B1    | V <sub>OUT</sub> | Switch Output. Output of the power switch.   |
| A1    | FLAGB            | Fault Output. Active LOW, open-drain output that indicates an over-current supply, under-voltage, or over-temperature state. |
| C2    | GND              | Ground.  |
| A2    | ON               | ON control input, active HIGH.   |

## Absolute Maximum Ratings

Stresses exceeding the absolute maximum ratings may damage the device. The device may not function or be operable above the recommended operating conditions and stressing the parts to these levels is not recommended. In addition, extended exposure to stresses above the recommended operating conditions may affect device reliability. The absolute maximum ratings are stress ratings only.

| Symbol        | Parameter   | Min.                          | Max. | Unit               |
|---------------|---|-------------------------------|------|--------------------|
|               | $V_{IN}$ , $V_{OUT}$ , ON, FLAGB, ISET to GND       | -0.3                          | 6.0  | V                  |
| $P_D$         | Power Dissipation at $T_A = 25^\circ\text{C}^{(1)}$ |                               | 1.2  | W                  |
| $T_J$         | Operating Temperature Range                         | -40                           | +125 | $^\circ\text{C}$   |
| $T_{STG}$     | Storage Temperature                                 | -65                           | +150 | $^\circ\text{C}$   |
| $\Theta_{JA}$ | Thermal Resistance, Junction to Ambient             |                               | 85   | $^\circ\text{C/W}$ |
| ESD           | Electrostatic Discharge Capability                  | Human Body Model, JESD22-A114 | 8000 | V                  |
|               |   | Machine Model, JESD22-A115    | 400  |                    |

**Note:**

1. Package power dissipation on one-square inch pad, two-ounce copper board.

## Recommended Operating Conditions

The Recommended Operating Conditions table defines the conditions for actual device operation. Recommended operating conditions are specified to ensure optimal performance to the datasheet specifications. Fairchild does not recommend exceeding them or designing to Absolute Maximum Ratings.

| Symbol   | Parameter                     | Min. | Max. | Unit             |
|----------|-------------------------------|------|------|------------------|
| $V_{IN}$ | Input Voltage                 | 1.8  | 5.5  | V                |
| $T_A$    | Ambient Operating Temperature | -40  | +85  | $^\circ\text{C}$ |

## Electrical Characteristics

$V_{IN} = 1.8$  to  $5.5$  V,  $T_A = -40$  to  $+85^\circ\text{C}$  unless otherwise noted. Typical values are at  $V_{IN} = 3.3$  V and  $T_A = 25^\circ\text{C}$ .

| Symbol                 | Parameter                               | Conditions  | Min.           | Typ. | Max. | Units            |
|------------------------|---|---|----------------|------|------|------------------|
| <b>Basic Operation</b> |   |   |                |      |      |                  |
| $V_{IN}$               | Operating Voltage                       |   | 1.8            |      | 5.5  | V                |
| $I_Q$                  | Quiescent Current                       | $I_{OUT}=0$ mA, $V_{ON}=V_{IN}$                             | $V_{IN}=1.8$ V | 70   |      | $\mu\text{A}$    |
|                        |   |   | $V_{IN}=3.3$ V | 75   |      |                  |
|                        |   |   | $V_{IN}=5.5$ V | 80   |      |                  |
| $R_{ON}$               | On Resistance                           | $T_A=25^\circ\text{C}$ , $I_{OUT}=200$ mA                   |                | 55   | 80   | $\text{m}\Omega$ |
|                        |   | $T_A=-40$ to $85^\circ\text{C}$ , $I_{OUT}=200$ mA          |                |      | 135  |                  |
| $V_{IH}$               | On Input Logic High Voltage ON          | $V_{IN}=1.8$ V  | 0.8            |      |      | V                |
|                        |   | $V_{IN}=5.5$ V  | 1.4            |      |      |                  |
| $V_{IL}$               | On Input Logic Low Voltage              | $V_{IN}=1.8$ V  |                |      | 0.5  | V                |
|                        |   | $V_{IN}=5.5$ V  |                |      | 1.0  |                  |
| $I_{IN}$               | On Input Leakage                        | $V_{ON}=V_{IN}$ or GND                                      | -1             | 0    | 1    | $\mu\text{A}$    |
| $V_{IN\_SD}$           | $V_{IN}$ Shutdown Current               | $V_{ON}=0$ V, $V_{IN}=5.5$ V, $V_{OUT}=\text{Short to GND}$ | -2             |      | 2    | $\mu\text{A}$    |
| $V_{FLB\_L}$           | FLAGB Output Logic Low Voltage          | $V_{IN}=5$ V, $I_{SINK}=10$ mA                              |                | 0.05 | 0.20 | V                |
|                        |   | $V_{IN}=1.8$ V, $I_{SINK}=10$ mA                            |                | 0.12 | 0.30 |                  |
| $I_{FLB\_H}$           | FLAGB Output Logic High Leakage Current | $V_{IN}=5$ V, Switch ON                                     |                |      | 1    | $\mu\text{A}$    |
| <b>Reverse Block</b>   |   |   |                |      |      |                  |
| $I_{SDT}$              | $V_{OUT}$ Shutdown Current              | $V_{ON}=0$ V, $V_{OUT}=5.5$ V, $V_{IN}=\text{Short-to-GND}$ | -2             |      | 2    | $\mu\text{A}$    |
| $V_{breakdown}$        | Reverse Breakdown Voltage               | $V_{IN}=V_{ON}=0$ V, $I_{OUT}=200$ $\mu\text{A}$            |                | 9    |      | V                |
| <b>Protections</b>     |   |   |                |      |      |                  |
| $I_{LIM}$              | Current Limit                           | $V_{IN}=3.3$ V, $V_{OUT}=3.0$ V, $R_{SET}=690$ $\Omega$     | 600            | 800  | 1000 | mA               |
|                        | Current Limit for FPF2195BUCX           | $V_{IN}=4.5$ V, $V_{OUT}=4.2$ V, $R_{SET}=15.8$ K $\Omega$  | 35             | 45   | 60   | mA               |
| $I_{LIM(MIN)}$         | Minimum Current Limit                   | $V_{IN}=3.3$ V, $V_{OUT}=3.0$ V, $R_{SET}=5516$ $\Omega$    |                | 100  |      | ma               |
| $T_{SD}$               | Thermal Shutdown                        | Shutdown Threshold  |                | 140  |      | $^\circ\text{C}$ |
|                        |   | Return from Shutdown  |                | 130  |      |                  |
|                        |   | Hysteresis  |                | 10   |      |                  |
| $V_{UVLO}$             | Under-Voltage Lockout                   | $V_{IN}$ Increasing   | 1.55           | 1.65 | 1.75 | V                |
| $V_{UVLO\_HYST}$       | Under-Voltage Lockout Hysteresis        |   |                | 50   |      | mV               |
| <b>Dynamic</b>         |   |   |                |      |      |                  |
| $t_{dON}$              | Delay On Time                           | $R_L=500$ $\Omega$ , $C_L=0.1$ $\mu\text{F}$                |                | 20   |      | $\mu\text{s}$    |
| $t_R$                  | $V_{OUT}$ Rise Time                     | $R_L=500$ $\Omega$ , $C_L=0.1$ $\mu\text{F}$                |                | 20   |      | $\mu\text{s}$    |
| $t_{ON}$               | Turn-On Time                            | $R_L=500$ $\Omega$ , $C_L=0.1$ $\mu\text{F}$                |                | 40   |      | $\mu\text{s}$    |
| $t_{dOFF}$             | Delay Off Time                          | $R_L=500$ $\Omega$ , $C_L=0.1$ $\mu\text{F}$                |                | 15   |      | $\mu\text{s}$    |
| $t_F$                  | $V_{OUT}$ Fall Time                     | $R_L=500$ $\Omega$ , $C_L=0.1$ $\mu\text{F}$                |                | 110  |      | $\mu\text{s}$    |
| $t_{OFF}$              | Turn-Off Time                           | $R_L=500$ $\Omega$ , $C_L=0.1$ $\mu\text{F}$                |                | 125  |      | $\mu\text{s}$    |
| $t_{BLANK}$            | Over-Current Blanking Time              | FPF2193, FPF2194  | 15             | 30   | 60   | ms               |
| $t_{RSTRT}$            | Auto-Restart                            | FPF2193 Only  | 225            | 450  | 900  | ms               |
| $t_{SC}$               | Short-Circuit Response Time             | $V_{IN}=V_{OUT}=3.3$ V, Moderate Over-Current Condition     |                | 5    |      | $\mu\text{s}$    |
|                        |   | $V_{IN}=V_{OUT}=3.3$ V, Hard Short                          |                | 30   |      | ns               |

## Typical Performance Characteristics

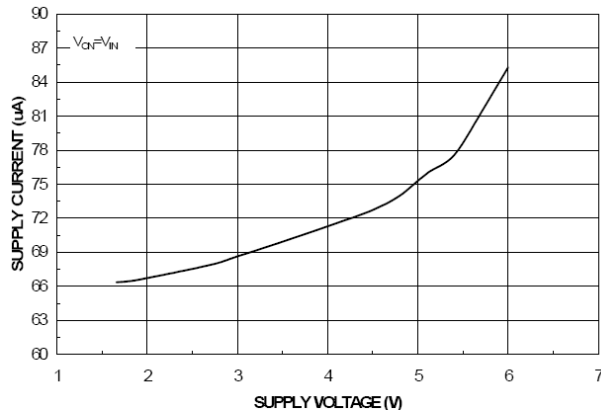

Figure 5. Quiescent Current vs. Input Voltage

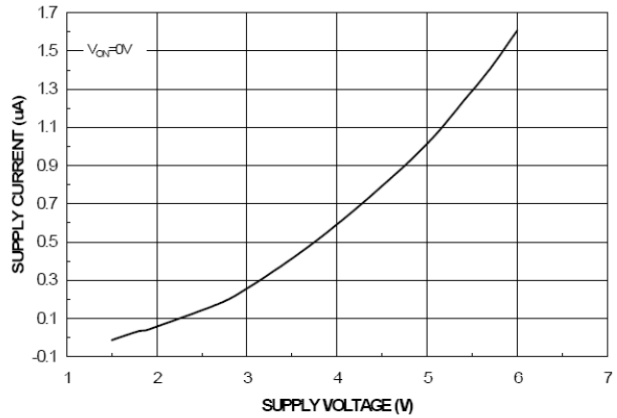

Figure 6. Quiescent Current vs. Input Voltage

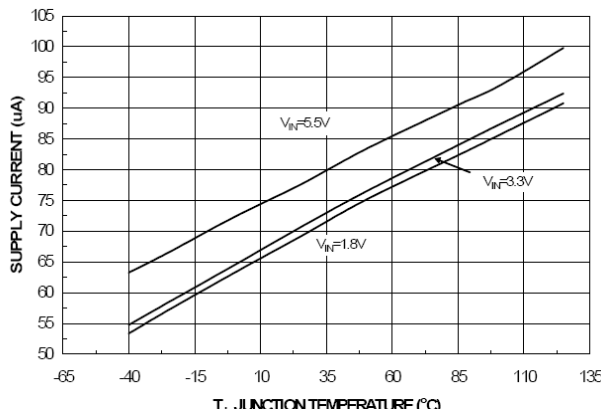

Figure 7. Quiescent Current vs. Temperature

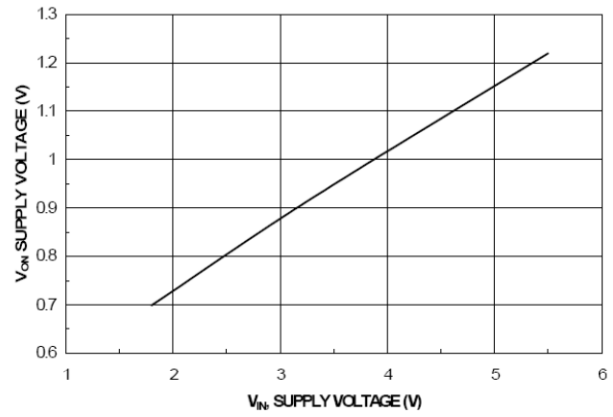

Figure 8.  $V_{ON}$  High Voltage vs. Input Voltage

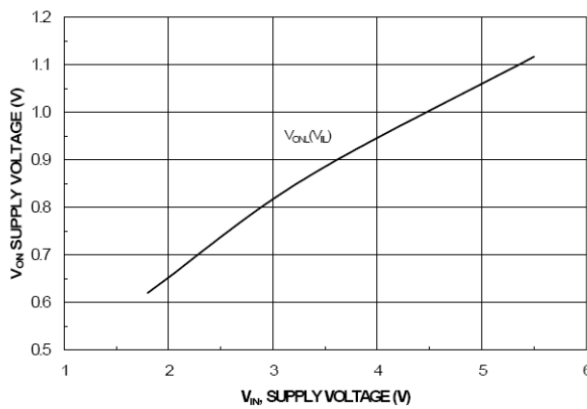

Figure 9.  $V_{ON}$  Low Voltage vs. Input Voltage

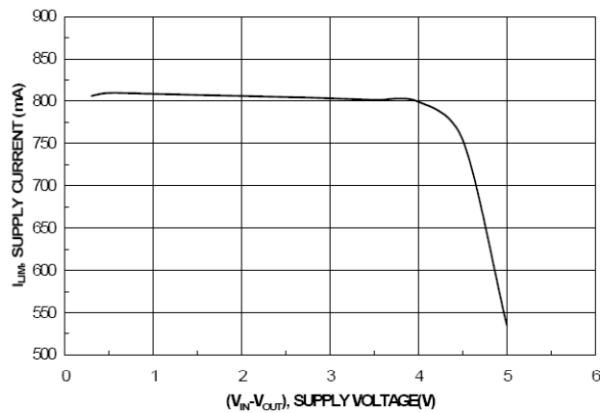

Figure 10. Current Limit vs. Output Voltage

Typical Performance Characteristics (Continued)

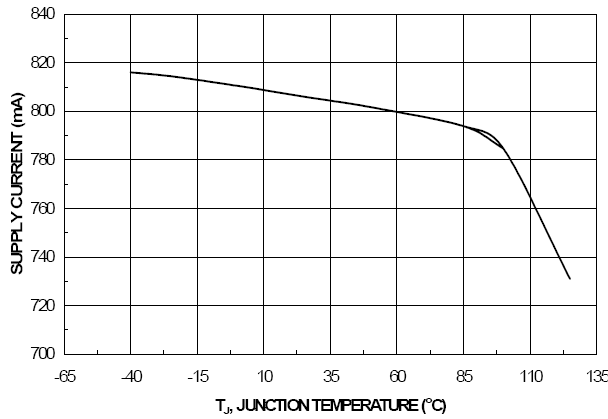

Figure 11. Current Limit vs. Temperature

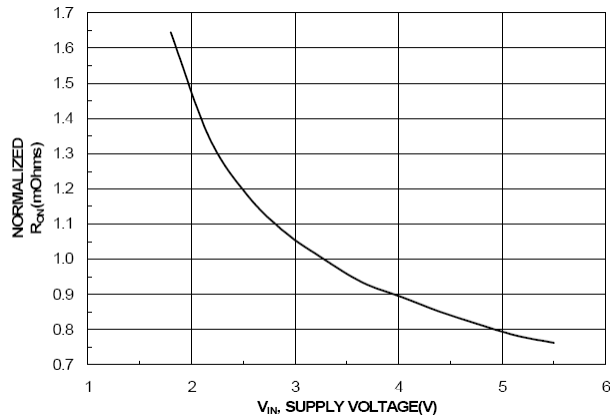

Figure 12. RON vs. VIN

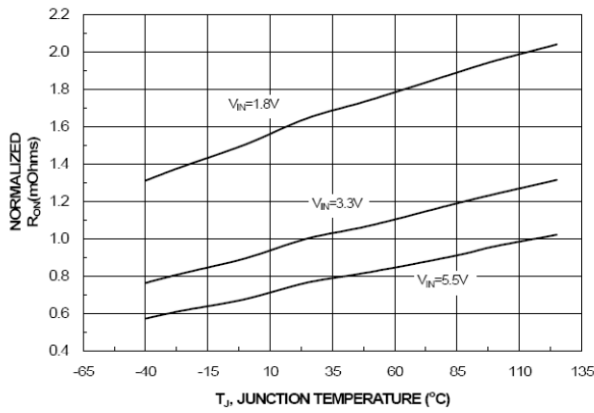

Figure 13. RON vs. Temperature

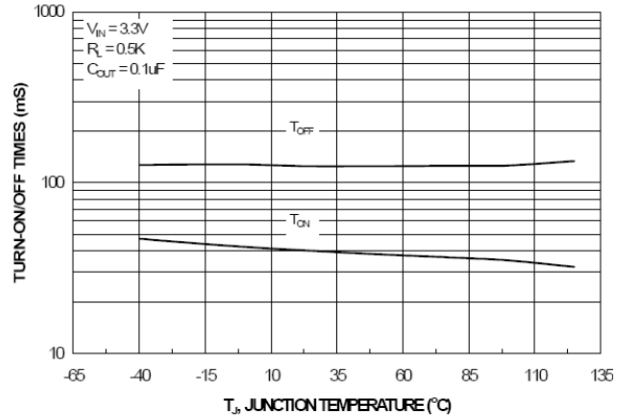

Figure 14. ton / toff vs. Temperature

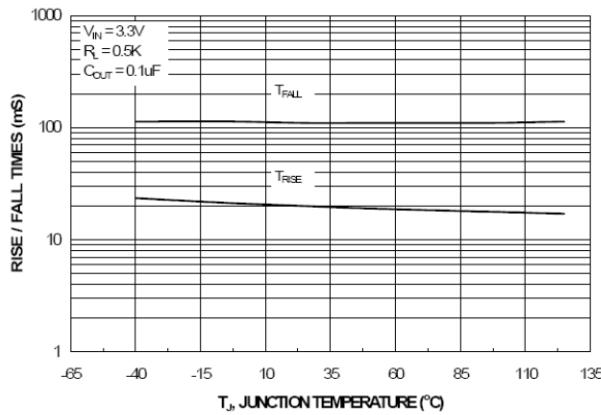

Figure 15. trise / tfall vs. Temperature

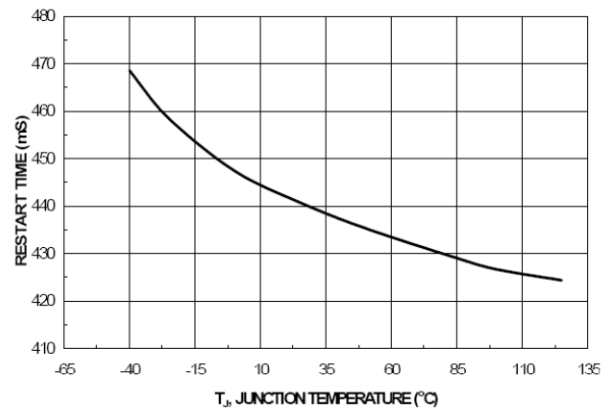

Figure 16. trst vs. Temperature



Typical Performance Characteristics (Continued)

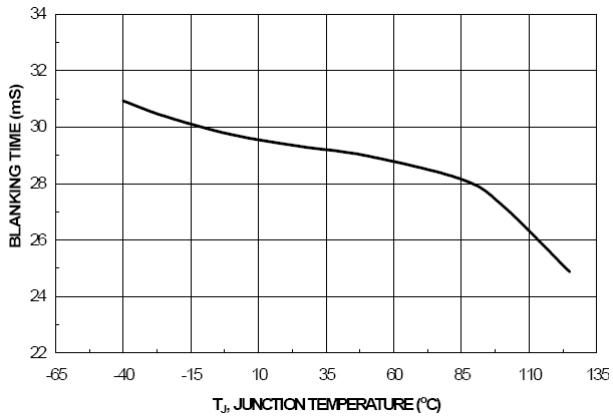

Figure 17.  $t_{BLANK}$  vs. Temperature

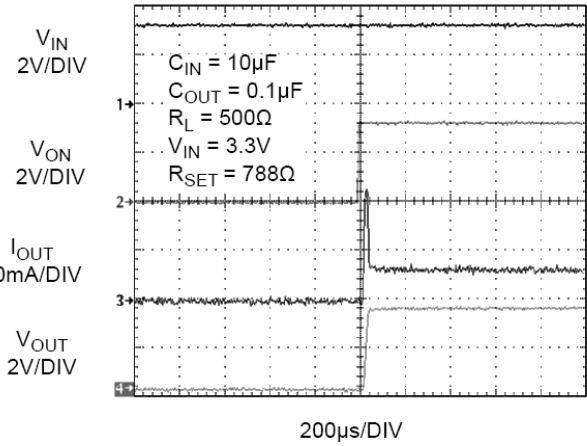

Figure 18.  $t_{ON}$  Response

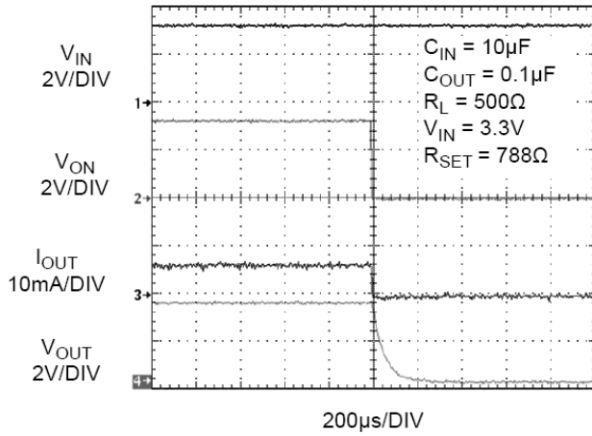

Figure 19.  $t_{OFF}$  Response

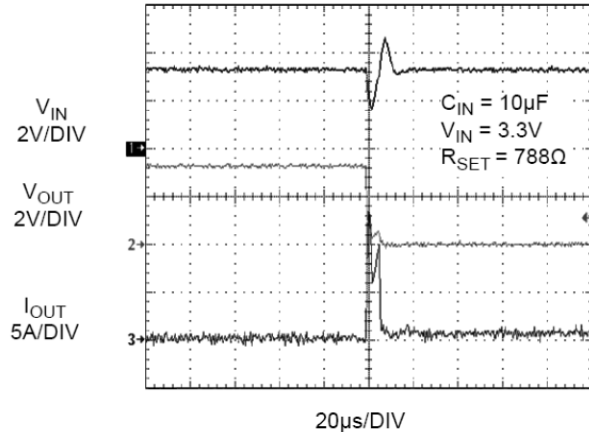

Figure 20. Short-Circuit Response Time (Output Shorted to GND)

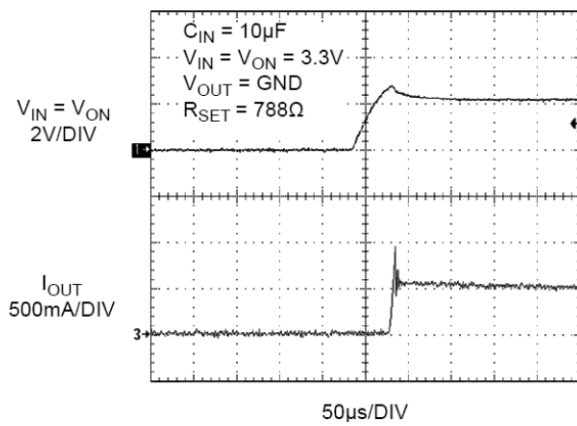

Figure 21. Current Limit Response Time (Switch is Powered into a Short)

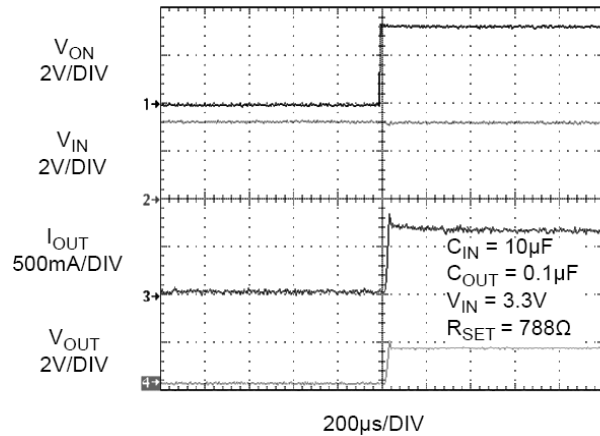

Figure 22. Current Limit Response Time (Output is Loaded by 2.2  $\Omega$ ,  $C_{OUT}=0.1 \mu F$ )

Typical Performance Characteristics (Continued)

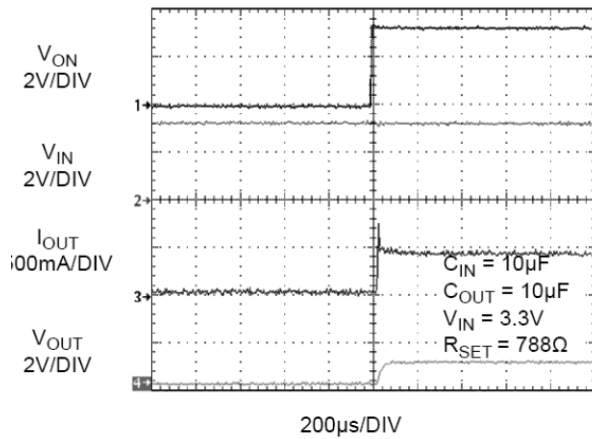

Figure 23. Current Limit Response Time (Output is Loaded by 2.2 Ω, C<sub>OUT</sub>=10 µF)

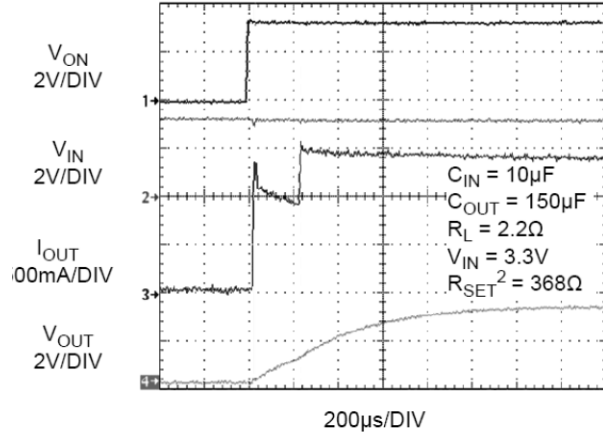

Figure 24. Short-Circuit Detection Function<sup>(2)</sup>

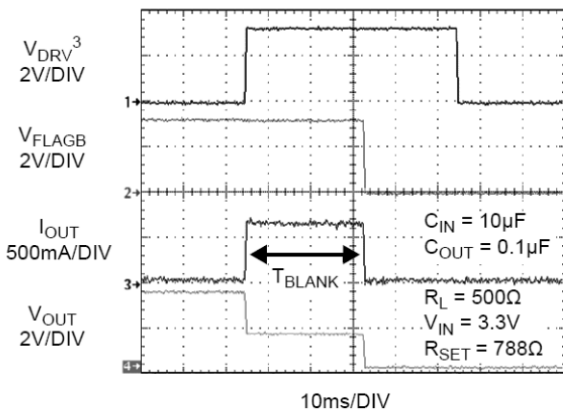

Figure 25. t<sub>BLANK</sub> vs. Response<sup>(3)</sup>

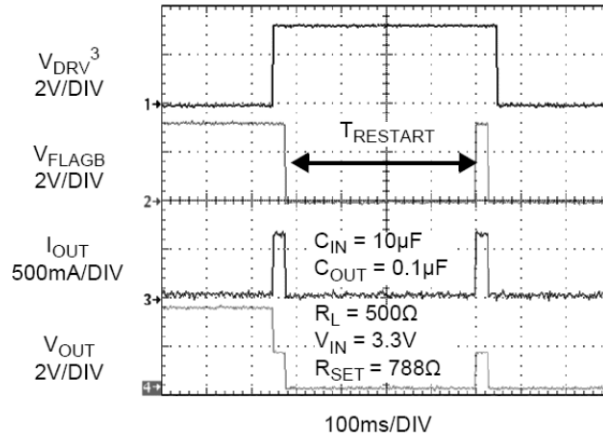

Figure 26. t<sub>RESTART</sub> vs. Response<sup>(3)</sup>

Notes:

2. When the output voltage is below V<sub>SCTH</sub>=1.1 V, the current limit value is set at 62.5% of the current limit value.
3. V<sub>DRV</sub> signal forces the device to go into over-current condition by loading.

## Functional Description

The FPF2193, FPF2194, and FPF2195 are current-limited switches that protect systems and loads that can be damaged or disrupted by the application of high currents. The core of each device is a 55 mΩ P-channel MOSFET and a controller capable of functioning over the wide input operating range of 1.8- 5.5 V. The controller protects against system malfunctions through current limiting, under-voltage lockout, and thermal shutdown. The current limit is adjustable from 100 mA (45 mA for FPF2195BUCX) to 1.5 A through the selection of an external resistor.

### On/Off Control

The ON pin controls the state of the switch. When ON is HIGH, the switch is in ON state. Activating ON continuously holds the switch in the ON state so long as there is no fault. For all versions, an under-voltage on VIN or a junction temperature in excess of 140°C overrides the ON control to turn off the switch. In addition, excessive currents cause the switch to turn off in the FPF2193 and FPF2194. The FPF2193 has an auto-restart feature that automatically turns the switch on again after 450 ms. For the FPF2194, the ON pin must be toggled to turn the switch on again. The FPF2195 does not turn off in response to an over-current condition, but remains operating in constant-current mode as long as ON is active and the thermal shutdown or under-voltage lockout have not activated.

### Fault Reporting

Upon the detection of an over-current, input under-voltage, or over-temperature condition, FLAGB signals the fault mode by activating LOW. For the FPF2193 and FPF2194, the FLAGB goes LOW at the end of the blanking time, while FLAGB goes LOW immediately for the FPF2195. FLAGB remains LOW through the auto-restart time for the FPF2195. For the FPF2194, FLAGB is latched LOW and ON must be toggled to release it. With the FPF2195, FLAGB is LOW during the faults and immediately returns HIGH at the end of the fault condition. FLAGB is an open-drain MOSFET that requires a pull-up resistor between VIN and FLAGB. During shutdown, the pull-down on FLAGB is disabled to reduce current draw from the supply.

### Current Limiting

The current limit ensures that the current through the switch doesn't exceed a maximum value, while not limiting at less than a minimum value. The current at which the parts limit is adjustable through the selection of an external resistor connected to ISET. Information for selecting the resistor is found in the Application Information section. The FPF2193 and FPF2194 have a blanking time of 30 ms, nominally, during which the switch acts as a constant current source. At the end of the blanking time, the switch is turned off. The FPF2195 has no current limit blanking period, so it remains in a constant current state until the ON pin is deactivated or the thermal shutdown turns off the switch.

For preventing the switch from large power dissipation during heavy load, a short-circuit detection feature is introduced. Short-circuit condition is detected by, observing the output voltage. The switch is put into short-circuit current-limiting mode if the switch is loaded with a

heavy load. When the output voltage drops below  $V_{SCTH}$ , the short-circuit detection threshold voltage, the current limit value is re-conditioned and the short-circuit current-limit value is decreased to 62.5% of the current limit value. This keeps the power dissipation of the part below a certain limit even at dead-short conditions at 5.5 V input voltage. The  $V_{SCTH}$  value is set to be 1 V. At around 1.1 V of output voltage, the switch is removed from short-circuit current-limiting mode and the current limit is set to the current limit value.

### Under-Voltage Lockout (UVLO)

The under-voltage lockout turns the switch off if the input voltage drops below the under-voltage lockout threshold. With the ON pin active, the input voltage rising above the under-voltage lockout threshold causes a controlled turn-on of the switch, which limits current over shoot.

### Thermal Shutdown

The thermal shutdown protects the die from internally or externally generated excessive temperatures. During an over-temperature condition, FLAGB is activated and the switch is turned off. The switch automatically turns on again if temperature of the die drops below the threshold temperature.

### Reverse-Current Blocking

The entire FPF2193/94/95 family has a reverse current blocking feature that protects the input source against current flow from output to input. For a standard USB power design, this is an important feature to protect the USB host from being damaged due to reverse current flow on  $V_{BUS}$ .

When the load switch is OFF, no current flows from the output to the input. If the switch is turned on and the output voltage is greater than input voltage, this feature is activated and turns off the switch. This prevents any current flow from output to input. The reverse-current blocking feature is deactivated if the  $V_{OUT} - V_{IN}$  is smaller than a typically 50 mV threshold. During this time, some current ( $50 \text{ mV}/R_{ON}$ ) flows from the output to input until input voltage becomes greater than output voltage. FLAGB operation is independent of the reverse-current blocking and does not report a fault condition if this feature is activated.

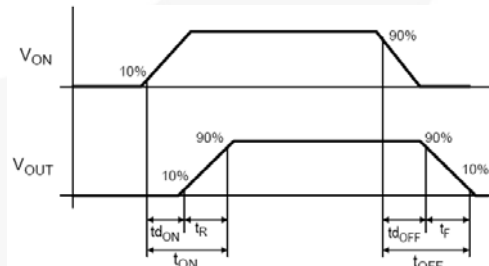

Figure 27. Timing Diagram

where:

- $t_{d\_ON}$  = Delay On Time
- $t_r$  =  $V_{OUT}$  Rise Time
- $t_{ON}$  = Turn-On Time
- $t_{d\_OFF}$  = Delay Off Time
- $t_f$  =  $V_{OUT}$  Fall Time
- $t_{OFF}$  = Turn-Off Time

## Application Information

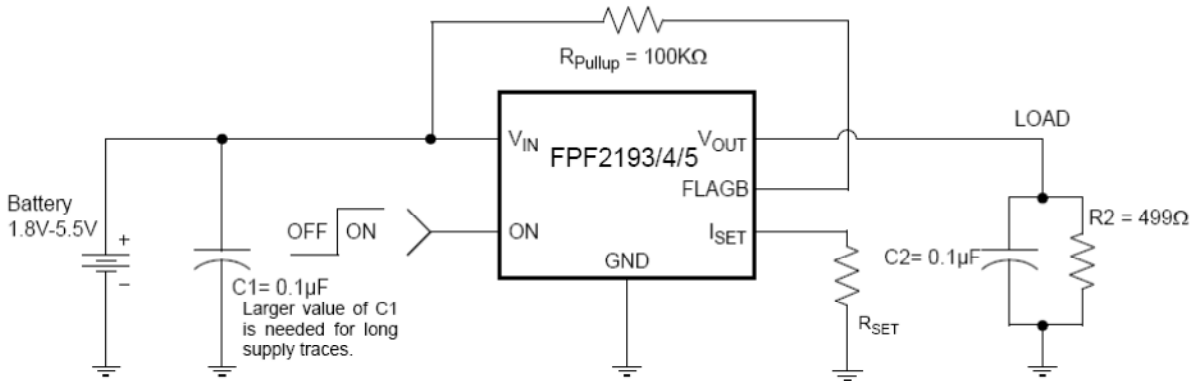

Figure 28. Typical Application

### Setting Current Limit

The FPF2193, FPF2194, and FPF2195 current limit is set with an external resistor connected between ISET and GND. This resistor is selected using the following equation:

$$R_{SET} = \frac{551.6}{I_{LIM}} \quad (1)$$

RSET is in Ω and ISET is in Amps.

Table 1 can also be used to select RSET. A typical application would be the 500 mA current required by a single USB port. Using Table 1, an appropriate selection for the RSET resistor would be 788 Ω. This ensures that the port load could draw 525 mA, but not more than 875 mA. Likewise for a dual-port system; an RSET of 368 Ω always delivers at least 1125 mA and never more than 1875 mA.

Table 1. Current Limit Various RSET Values

| RSET(Ω)              | Min. Current Limit (mA) | Typ. Current Limit (mA) | Max. Current Limit (mA) |
|----------------------|-------------------------|-------------------------|-------------------------|
| 368                  | 1125                    | 1500                    | 1875                    |
| 441                  | 928                     | 1250                    | 1562                    |
| 552                  | 750                     | 1000                    | 1250                    |
| 613                  | 675                     | 900                     | 1125                    |
| 690                  | 600                     | 800                     | 1000                    |
| 788                  | 525                     | 700                     | 875                     |
| 919                  | 450                     | 600                     | 750                     |
| 1103                 | 375                     | 500                     | 625                     |
| 1226                 | 338                     | 450                     | 563                     |
| 1379                 | 300                     | 400                     | 500                     |
| 1576                 | 263                     | 350                     | 438                     |
| 1839                 | 225                     | 300                     | 375                     |
| 2206                 | 188                     | 250                     | 313                     |
| 2758                 | 150                     | 200                     | 250                     |
| 3677                 | 113                     | 150                     | 188                     |
| 5516                 | 75                      | 100                     | 125                     |
| 15800 <sup>(4)</sup> | 35                      | 45                      | 60                      |

**Note:**

4. FPF2195BUCX only.

### Input Capacitor

To limit the voltage drop on the input supply caused by transient inrush currents when the switch is turned on into a discharged load capacitor or a short-circuit, a capacitor needs to be placed between VIN and GND. A 0.1 µF ceramic capacitor, CIN, placed close to the pins is usually sufficient. Higher values of CIN can be used to further reduce the voltage drop.

### Output Capacitor

A 0.1 µF capacitor, COUT, should be placed between VOUT and GND. This capacitor prevents parasitic board inductances from forcing VOUT below GND when the switch turns off. For the FPF2193 and FPF2194, the total output capacitance needs to be kept below a maximum value, COUT(max), to prevent the part from registering an over-current condition and turning off the switch. The maximum output capacitance can be determined from the following formula:

$$C_{OUT(max)} = \frac{I_{LIM(max)} \times t_{BLANK(min)}}{V_{IN}} \quad (2)$$

### Power Dissipation

During normal operation as a switch, the power dissipated depends upon the level at which the current limit is set. The maximum allowed setting for the current limit is 1.5 A and results in a power dissipation of:

$$P = (I_{LIM})^2 \times R_{ON} = (1.5)^2 \times 0.055 = 123.75mW \quad (3)$$

If the part goes into current limit, the maximum power dissipation occurs when the output is shorted to ground. For the FPF2193, the power dissipation scales by the auto-restart time, tRSTRT, and the over-current blanking time, tBLANK, so that the maximum power dissipated is:

$$P(max) = \frac{t_{BLANK}}{t_{BLANK} + t_{RSTRT}} \times V_{IN(max)} \times I_{LIM(max)} \quad (4)$$

$$= \frac{30}{30 + 450} \times 5.5 \times 1.5 = 515.6mW$$

This is more power than the package can dissipate, but the thermal shutdown of the part activates to protect the part from damage due to excessive heating. When using the FPF2194, attention must be given to the manual resetting of the part. The junction temperature is only able to increase to the thermal shutdown threshold. Once this temperature has been reached, toggling ON does not turn the switch on until the junction temperature drops. For the FPF2195, a short on the output causes the part to operate in a constant-current state, dissipating a worst-case power of:

$$\begin{aligned} P(\max) &= V_{IN}(\max) \times I_{LIM}(\max) \\ &= 5.5 \times 1.5 = 8.25W \end{aligned} \quad (5)$$

This large amount of power activates the thermal shutdown and the part cycles in and out of thermal shutdown as long as the ON pin is active and the short is present.

### Board Layout

For best performance, all traces should be as short as possible. To be most effective, the input and output capacitors should be placed close to the device to minimize the effects that parasitic trace inductances may have on normal and short-circuit operation. Using wide traces for  $V_{IN}$ ,  $V_{OUT}$ , and GND help to minimize parasitic electrical effects along with minimizing the case-to-ambient thermal impedance.

### Physical Dimensions

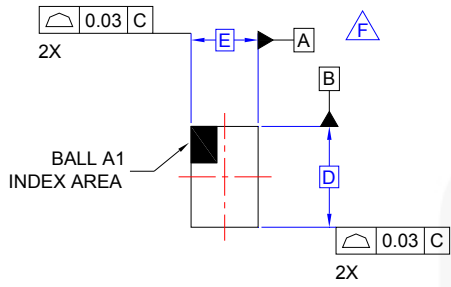

TOP VIEW

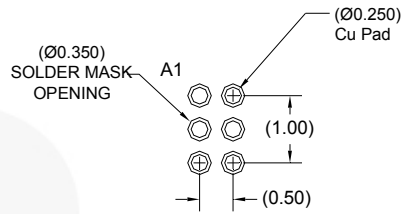

RECOMMENDED LAND PATTERN (NSMD PAD TYPE)

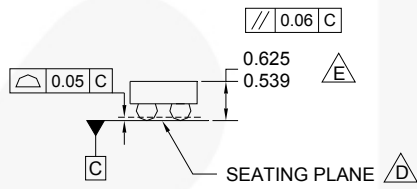

SIDE VIEWS

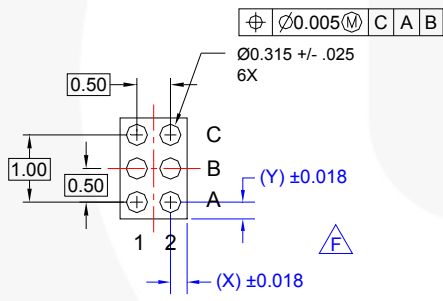
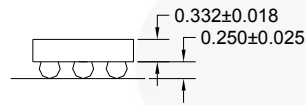

BOTTOM VIEW

#### NOTES:

- A. NO JEDEC REGISTRATION APPLIES.
- B. DIMENSIONS ARE IN MILLIMETERS.
- C. DIMENSIONS AND TOLERANCE PER ASMEY14.5M, 1994.
- D. DATUM C IS DEFINED BY THE SPHERICAL CROWNS OF THE BALLS.
- E. PACKAGE NOMINAL HEIGHT IS 582 MICRONS ±43 MICRONS (539-625 MICRONS).
- F. FOR DIMENSIONS D, E, X, AND Y SEE PRODUCT DATASHEET.
- G. DRAWING FILNAME: MKT-UC006AFrev2.





Figure 29. 6-Ball, Wafer-Level Chip-Scale Package (WLCSP)

| D           | E           | X     | Y     |
|-------------|-------------|-------|-------|
| 1.480±0.030 | 0.980±0.030 | 0.240 | 0.240 |



**TRADEMARKS**

The following includes registered and unregistered trademarks and service marks, owned by Fairchild Semiconductor and/or its global subsidiaries, and is not intended to be an exhaustive list of all such trademarks.

- |   |  |   |   |
|---|--|---|---|
| AccuPower™  | F-PFS™   |  |  |
| Awinda®   | FRFET®   | PowerTrench®  | TinyBoost®  |
| AX-CAP®*  | Global Power Resource™                         | PowerXS™  | TinyBuck®   |
| BitSiC™   | GreenBridge™                                   | Programmable Active Droop™  | TinyCalc™   |
| Build it Now™   | Green FPS™                                     | QFET®   | TinyLogic™  |
| CorePLUS™   | Green FPS™ e-Series™                           | QS™   | TINYOPTO™   |
| CorePOWER™  | Gmax™  | Quiet Series™   | TinyPower™  |
| CROSSVOLT™  | GTO™   | RapidConfigure™   | TinyPWM™  |
| CTL™  | IntelliMAX™                                    |  | TinyWire™   |
| Current Transfer Logic™   | ISOPLANAR™                                     | Saving our world, 1mW/W/kW at a time™   | TranSiC™  |
| DEUXPEED®   | Making Small Speakers Sound Louder and Better™ | SignalWise™   | TriFault Detect™  |
| Dual Cool™  | MegaBuck™                                      | SmartMax™   | TRUECURRENT®*   |
| EcoSPARK®   | MICROCOUPLER™                                  | SMART START™  | µSerDes™  |
| EfficientMax™   | MicroFET™                                      | Solutions for Your Success™   |  |
| ESBC™   | MicroPak™                                      | SPM®  | UHC®  |
|  | MicroPak2™                                     | STEALTH™  | Ultra FRFET™  |
| Fairchild®  | MillerDrive™                                   | SuperFET®   | UniFET™   |
| Fairchild Semiconductor®  | MotionMax™                                     | SuperSOT™-3   | VCX™  |
| FACT Quiet Series™  | MotionGrid®                                    | SuperSOT™-6   | VisualMax™  |
| FACT®   | MTi®   | SuperSOT™-8   | VoltagePlus™  |
| FAST®   | MTX®   | SupreMOS®   | XS™   |
| FastvCore™  | MVN®   | SyncFET™  | Xsens™  |
| FETBench™   | mWSaver®                                       | Sync-Lock™  | 仙童™   |
| FPS™  | OptoHiT™                                       |   |   |

\* Trademarks of System General Corporation, used under license by Fairchild Semiconductor.

**DISCLAIMER**

FAIRCHILD SEMICONDUCTOR RESERVES THE RIGHT TO MAKE CHANGES WITHOUT FURTHER NOTICE TO ANY PRODUCTS HEREIN TO IMPROVE RELIABILITY, FUNCTION, OR DESIGN. TO OBTAIN THE LATEST, MOST UP-TO-DATE DATASHEET AND PRODUCT INFORMATION, VISIT OUR WEBSITE AT <http://www.fairchildsemi.com>. FAIRCHILD DOES NOT ASSUME ANY LIABILITY ARISING OUT OF THE APPLICATION OR USE OF ANY PRODUCT OR CIRCUIT DESCRIBED HEREIN; NEITHER DOES IT CONVEY ANY LICENSE UNDER ITS PATENT RIGHTS, NOR THE RIGHTS OF OTHERS. THESE SPECIFICATIONS DO NOT EXPAND THE TERMS OF FAIRCHILD'S WORLDWIDE TERMS AND CONDITIONS, SPECIFICALLY THE WARRANTY THEREIN, WHICH COVERS THESE PRODUCTS.

**LIFE SUPPORT POLICY**

FAIRCHILD'S PRODUCTS ARE NOT AUTHORIZED FOR USE AS CRITICAL COMPONENTS IN LIFE SUPPORT DEVICES OR SYSTEMS WITHOUT THE EXPRESS WRITTEN APPROVAL OF FAIRCHILD SEMICONDUCTOR CORPORATION.

As used herein:

1. Life support devices or systems are devices or systems which, (a) are intended for surgical implant into the body or (b) support or sustain life, and (c) whose failure to perform when properly used in accordance with instructions for use provided in the labeling, can be reasonably expected to result in a significant injury of the user.
2. A critical component in any component of a life support, device, or system whose failure to perform can be reasonably expected to cause the failure of the life support device or system, or to affect its safety or effectiveness.

**ANTI-COUNTERFEITING POLICY**

Fairchild Semiconductor Corporation's Anti-Counterfeiting Policy. Fairchild's Anti-Counterfeiting Policy is also stated on our external website, [www.fairchildsemi.com](http://www.fairchildsemi.com), under Sales Support.

Counterfeiting of semiconductor parts is a growing problem in the industry. All manufacturers of semiconductor products are experiencing counterfeiting of their parts. Customers who inadvertently purchase counterfeit parts experience many problems such as loss of brand reputation, substandard performance, failed applications, and increased cost of production and manufacturing delays. Fairchild is taking strong measures to protect ourselves and our customers from the proliferation of counterfeit parts. Fairchild strongly encourages customers to purchase Fairchild parts either directly from Fairchild or from Authorized Fairchild Distributors who are listed by country on our web page cited above. Products customers buy either from Fairchild directly or from Authorized Fairchild Distributors are genuine parts, have full traceability, meet Fairchild's quality standards for handling and storage and provide access to Fairchild's full range of up-to-date technical and product information. Fairchild and our Authorized Distributors will stand behind all warranties and will appropriately address any warranty issues that may arise. Fairchild will not provide any warranty coverage or other assistance for parts bought from Unauthorized Sources. Fairchild is committed to combat this global problem and encourage our customers to do their part in stopping this practice by buying direct or from authorized distributors.

**PRODUCT STATUS DEFINITIONS**

**Definition of Terms**

| Datasheet Identification | Product Status        | Definition  |
|--------------------------|-----------------------|---|
| Advance Information      | Formative / In Design | Datasheet contains the design specifications for product development. Specifications may change in any manner without notice.   |
| Preliminary              | First Production      | Datasheet contains preliminary data; supplementary data will be published at a later date. Fairchild Semiconductor reserves the right to make changes at any time without notice to improve design. |
| No Identification Needed | Full Production       | Datasheet contains final specifications. Fairchild Semiconductor reserves the right to make changes at any time without notice to improve the design.   |
| Obsolete                 | Not In Production     | Datasheet contains specifications on a product that is discontinued by Fairchild Semiconductor. The datasheet is for reference information only.  |

Rev. I71

ON Semiconductor and  are trademarks of Semiconductor Components Industries, LLC dba ON Semiconductor or its subsidiaries in the United States and/or other countries. ON Semiconductor owns the rights to a number of patents, trademarks, copyrights, trade secrets, and other intellectual property. A listing of ON Semiconductor's product/patent coverage may be accessed at [www.onsemi.com/site/pdf/Patent-Marking.pdf](http://www.onsemi.com/site/pdf/Patent-Marking.pdf). ON Semiconductor reserves the right to make changes without further notice to any products herein. ON Semiconductor makes no warranty, representation or guarantee regarding the suitability of its products for any particular purpose, nor does ON Semiconductor assume any liability arising out of the application or use of any product or circuit, and specifically disclaims any and all liability, including without limitation special, consequential or incidental damages. Buyer is responsible for its products and applications using ON Semiconductor products, including compliance with all laws, regulations and safety requirements or standards, regardless of any support or applications information provided by ON Semiconductor. "Typical" parameters which may be provided in ON Semiconductor data sheets and/or specifications can and do vary in different applications and actual performance may vary over time. All operating parameters, including "Typicals" must be validated for each customer application by customer's technical experts. ON Semiconductor does not convey any license under its patent rights nor the rights of others. ON Semiconductor products are not designed, intended, or authorized for use as a critical component in life support systems or any FDA Class 3 medical devices or medical devices with a same or similar classification in a foreign jurisdiction or any devices intended for implantation in the human body. Should Buyer purchase or use ON Semiconductor products for any such unintended or unauthorized application, Buyer shall indemnify and hold ON Semiconductor and its officers, employees, subsidiaries, affiliates, and distributors harmless against all claims, costs, damages, and expenses, and reasonable attorney fees arising out of, directly or indirectly, any claim of personal injury or death associated with such unintended or unauthorized use, even if such claim alleges that ON Semiconductor was negligent regarding the design or manufacture of the part. ON Semiconductor is an Equal Opportunity/Affirmative Action Employer. This literature is subject to all applicable copyright laws and is not for resale in any manner.

## PUBLICATION ORDERING INFORMATION

### LITERATURE FULFILLMENT:

Literature Distribution Center for ON Semiconductor  
19521 E. 32nd Pkwy, Aurora, Colorado 80011 USA  
**Phone:** 303-675-2175 or 800-344-3860 Toll Free USA/Canada  
**Fax:** 303-675-2176 or 800-344-3867 Toll Free USA/Canada  
**Email:** [orderlit@onsemi.com](mailto:orderlit@onsemi.com)

**N. American Technical Support:** 800-282-9855 Toll Free  
USA/Canada  
**Europe, Middle East and Africa Technical Support:**  
Phone: 421 33 790 2910  
**Japan Customer Focus Center**  
Phone: 81-3-5817-1050

**ON Semiconductor Website:** [www.onsemi.com](http://www.onsemi.com)  
**Order Literature:** <http://www.onsemi.com/orderlit>  
For additional information, please contact your local  
Sales Representative