

FEATURES

- **1.6V to 5.5V Input Voltage Range**
- **Internal Soft-Start**
- **Low Ripple Burst Mode® Operation**
 Output Ripple: <math><20\text{mV}_{\text{p-p}}</math>
 I_{Q} : 50 μA
- **2.25MHz Constant-Frequency Operation**
- High Efficiency: Up to 93%
- 250mA Output Current ($V_{\text{IN}} = 1.8\text{V}$, $V_{\text{OUT}} = 1.2\text{V}$)
- 450mA Peak Inductor Current
- No Schottky Diode Required
- Low Dropout Operation: 100% Duty Cycle
- 0.611V Reference Voltage
- Stable with Ceramic Capacitors
- Shutdown Mode Draws <math><1\mu\text{A}</math> Supply Current
- Current Mode Operation for Excellent Line and Load Transient Response
- Overtemperature Protection
- Available in a Low Profile (0.75mm) 6-Lead (2mm x 3mm) DFN Package

APPLICATIONS

- 2 AA-Cell Applications
- Cellular Phones
- Digital Cameras
- MP3 Players

DESCRIPTION

The LTC®3549 is a high efficiency, monolithic synchronous buck regulator using a constant-frequency, current mode architecture. The output voltage is adjusted via an external resistor divider.

A fixed switching frequency of 2.25MHz is supported. This switching frequency allows the use of small surface mount inductors and capacitors, including ceramics.

Supply current during Burst Mode operation is only 50 μA dropping to <math><1\mu\text{A}</math> in shutdown. The 1.6V to 5.5V input voltage range makes the LTC3549 ideally suited for single cell Li-Ion, Li-Metal and 2-cell alkaline, NiCd or NiMH battery-powered applications. 100% duty cycle capability provides low dropout operation, extending battery life in portable systems. Burst Mode operation can be user-enabled, increasing efficiency at light loads, further extending battery life.

The internal synchronous switch increases efficiency and eliminates the need for an external Schottky diode. Internal soft-start offers controlled output voltage rise time at start-up without the need for external components.

LT, LT, LTC and LTM are registered trademarks of Linear Technology Corporation. Burst Mode is a registered trademark of Linear Technology Corporation. All other trademarks are the property of their respective owners. Protected by U.S. Patents, including 5481178, 6580258, 6304066, 6127815, 6498466, 6611131.

TYPICAL APPLICATION

High Efficiency Step-Down Converter

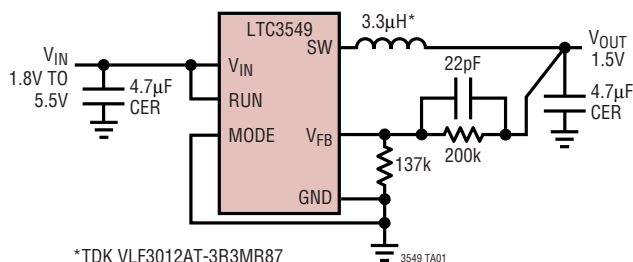

Burst Mode Efficiency, $V_{\text{OUT}} = 1.5\text{V}$

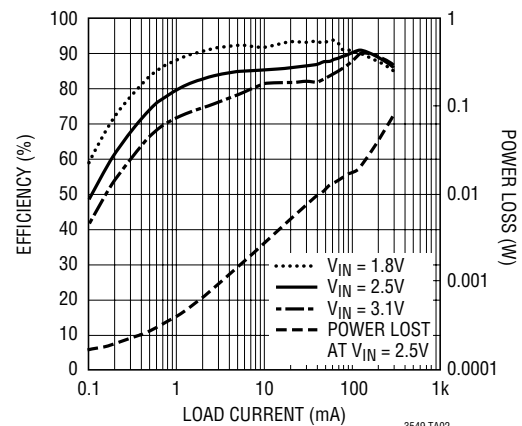

ABSOLUTE MAXIMUM RATINGS

(Note 1)

Input Supply Voltage.....	-0.3V to 6V
RUN, V _{FB} , MODE Voltages	-0.3V to (V _{IN} + 0.3V)
SW Voltage < 100ns Pulse.....	-0.3V to (V _{IN} + 0.3V)
Operating Temperature Range (Note 2) ...	-40°C to 85°C
Junction Temperature (Note 3)	125°C
Storage Temperature Range.....	-65°C to 125°C

PACKAGE/ORDER INFORMATION

TOP VIEW

V_{FB} RUN MODE

6 5 4

7

V_{IN} GND SW

DCB PACKAGE
6-LEAD (2mm × 3mm) PLASTIC DFN

T_{JMAX} = 125°C, θ_{JA} = 64°C/W
EXPOSED PAD (PIN 7) IS GND
MUST BE SOLDERED TO PCB

ORDER PART NUMBER	DCB PART MARKING
LTC3549EDCB	LBZR

Order Options Tape and Reel: Add #TR
Lead Free: Add #PBF Lead Free Tape and Reel: Add #TRPBF
Lead Free Part Marking: <http://www.linear.com/leadfree/>

Consult LTC Marketing for parts specified with wider operating temperature ranges.

ELECTRICAL CHARACTERISTICS

The ● denotes the specifications which apply over the full operating temperature range, otherwise specifications are at T_A = 25°C, V_{IN} = 2.2V.

SYMBOL	PARAMETER	CONDITIONS	MIN	TYP	MAX	UNITS	
V _{IN}	Input Voltage Range	●	1.6		5.5	V	
V _{RUN}	RUN Threshold	●	0.3	0.7	1.1	V	
I _{RUN}	RUN Leakage Current	V _{RUN} = 0 or 2.2V		0.01	1	μA	
V _{MODE}	MODE Threshold	●	0.3	0.65	1.1	V	
I _{MODE}	MODE Leakage Current	V _{MODE} = 0 or 2.2V		0.01	1	μA	
V _{FB}	Regulated Feedback Voltage	T _A = 25°C (Note 4) 0°C ≤ T _A ≤ 85°C (Note 4) -40°C ≤ T _A ≤ 85°C (Note 4)	●	0.599 0.597 0.596	0.611 0.611 0.611	0.623 0.623 0.626	V V V
I _{VFB}	Feedback Current	●			±30	nA	
ΔV _{OVL}	ΔV _{FBOVL} Overvoltage Lockout	ΔV _{OVL} = ΔV _{FBOVL} - V _{FB} (Note 6)		40	60	80	mV
ΔV _{FB}	Reference Voltage Line Regulation	1.6V < V _{IN} < 5.5V (Note 4)	●		0.04	0.4	%/V
ΔV _{OUT}	Output Voltage Line Regulation	I _{OUT} = 100mA, 1.6V < V _{IN} < 5.5V (Note 7)			0.04	0.4	%/V
I _{PK}	Peak Inductor Current	V _{FB} = 0.5V or V _{OUT} = 90%		0.3	0.45	0.6	A
V _{LOADREG}	Output Voltage Load Regulation	Pulse Skip Mode, V _{OUT} = 1.2V, 50mA < I _{LOAD} < 250mA (Note 7)			0.5		%

ELECTRICAL CHARACTERISTICS

The ● denotes the specifications which apply over the full operating temperature range, otherwise specifications are at $T_A = 25^\circ\text{C}$, $V_{IN} = 2.2\text{V}$.

SYMBOL	PARAMETER	CONDITIONS	MIN	TYP	MAX	UNITS
I_S	Input DC Bias Current	(Note 5)				
	Active Mode	$V_{OUT} = 90\%$, $I_{LOAD} = 0\text{A}$		300	475	μA
	Sleep Mode	$V_{OUT} = 103\%$, $I_{LOAD} = 0\text{A}$		50	95	μA
	Shutdown	$V_{RUN} = 0\text{V}$, $V_{IN} = 5.5\text{V}$		0.1	5	μA
f_{OSC}	Nominal Oscillator Frequency		● 1.8	2.25	2.7	MHz
t_{SS}	Soft-Start Period	RUN↑		1		ms
R_{PFET}	$R_{DS(ON)}$ of P-Channel FET	$I_{SW} = 100\text{mA}$, Wafer Level		0.5		Ω
		$I_{SW} = 100\text{mA}$, DD Package (Note 7)		0.56		Ω
R_{NFET}	$R_{DS(ON)}$ of N-Channel FET	$I_{SW} = 100\text{mA}$, Wafer Level		0.35		Ω
		$I_{SW} = 100\text{mA}$, DD Package (Note 7)		0.4		Ω
I_{LSW}	SW Leakage	$V_{RUN} = 0\text{V}$, $V_{SW} = 0\text{V}$ or 5.5V , $V_{IN} = 5.5\text{V}$		± 0.1	± 1	μA

Note 1: Stresses beyond those listed under Absolute Maximum Ratings may cause permanent damage to the device. Exposure to any Absolute Maximum Rating condition for extended periods may affect device reliability and lifetime. Voltage on any pin may not exceed 6V.

Note 2: The LTC3549E is guaranteed to meet performance specifications from 0°C to 85°C . Specifications over the -40°C to 85°C operating temperature range are assured by design, characterization and correlation with statistical process controls.

Note 3: T_J is calculated from the ambient temperature T_A and power dissipation P_D according to the following formula:

$$\text{LTC3549: } T_J = T_A + (P_D)(64^\circ\text{C/W})$$

This IC includes overtemperature protection that is intended to protect the device during momentary overload conditions. Overtemperature protection

becomes active at a junction temperature greater than the maximum operating junction temperature. Continuous operation above the specified maximum operating junction temperature may impair device reliability.

Note 4: The LTC3549 is tested in a proprietary test mode that connects V_{FB} to the output of the error amplifier.

Note 5: Dynamic supply current is higher due to the gate charge being delivered at the switching frequency.

Note 6: ΔV_{OVL} is the amount V_{FB} must exceed the regulated feedback voltage.

Note 7: Determined by design, not production tested.

TYPICAL PERFORMANCE CHARACTERISTICS

(From Typical Application on the front page, except for the resistive divider resistor values)

Efficiency/Power Loss vs Load Current, $V_{OUT} = 1.5V$, Burst Mode

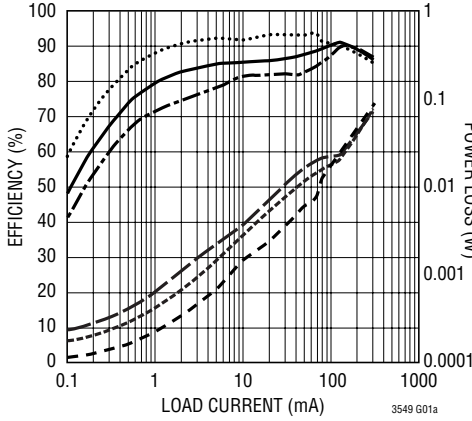

EFFICIENCY
 $V_{IN} = 1.8V$
 ——— $V_{IN} = 2.5V$
 - - - $V_{IN} = 3.1V$

POWER LOSS
 $V_{IN} = 1.8V$
 - - - $V_{IN} = 2.5V$
 - - - $V_{IN} = 3.1V$

Efficiency/Power Loss vs Load Current, $V_{OUT} = 1.5V$, Pulse Skip

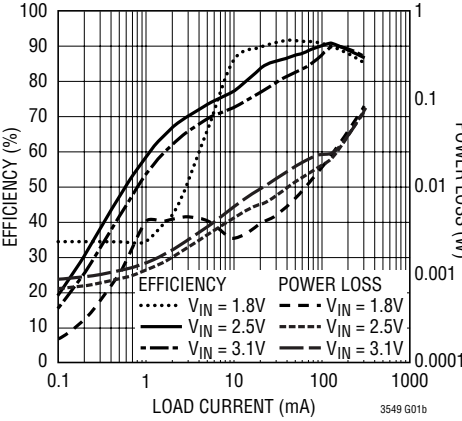

EFFICIENCY
 $V_{IN} = 1.8V$
 ——— $V_{IN} = 2.5V$
 - - - $V_{IN} = 3.1V$

POWER LOSS
 $V_{IN} = 1.8V$
 - - - $V_{IN} = 2.5V$
 - - - $V_{IN} = 3.1V$

Efficiency vs Input Voltage, $V_{OUT} = 1.2V$, Burst Mode Operation

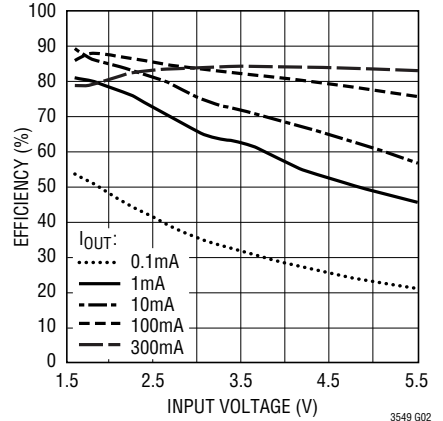

EFFICIENCY
 $I_{OUT} = 0.1mA$
 ——— $I_{OUT} = 1mA$
 - - - $I_{OUT} = 10mA$
 - - - $I_{OUT} = 100mA$
 - - - $I_{OUT} = 300mA$

Efficiency vs Input Voltage, $V_{OUT} = 1.2V$, Pulse Skip

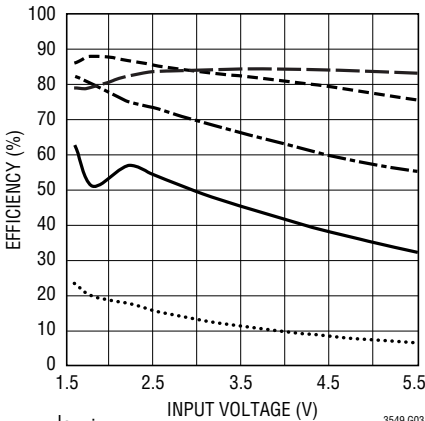

EFFICIENCY
 $I_{OUT} = 0.1mA$
 ——— $I_{OUT} = 1mA$
 - - - $I_{OUT} = 10mA$
 - - - $I_{OUT} = 300mA$

Efficiency vs Load Current, $V_{OUT} = 1.8V$, Burst Mode

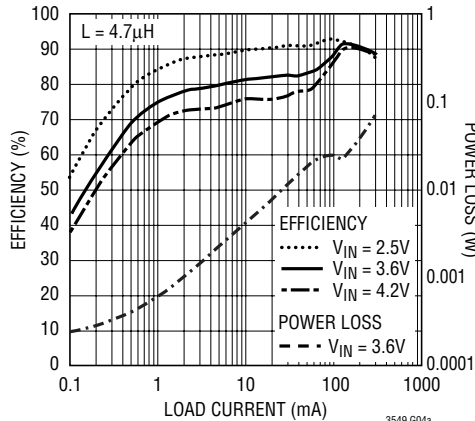

EFFICIENCY
 $V_{IN} = 2.5V$
 ——— $V_{IN} = 3.6V$
 - - - $V_{IN} = 4.2V$

POWER LOSS
 $V_{IN} = 3.6V$

Efficiency vs Load Current, $V_{OUT} = 1.8V$, Pulse Skip

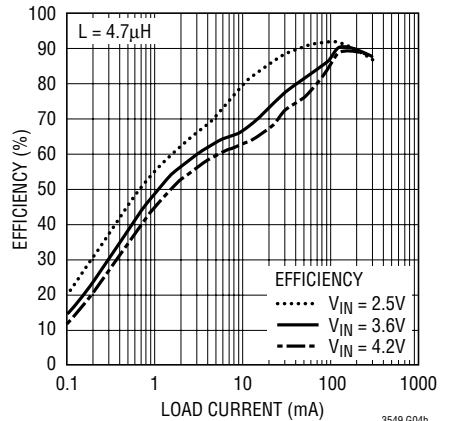

EFFICIENCY
 $V_{IN} = 2.5V$
 ——— $V_{IN} = 3.6V$
 - - - $V_{IN} = 4.2V$

Efficiency vs Load Current, $V_{OUT} = 1.2V$, Burst Mode

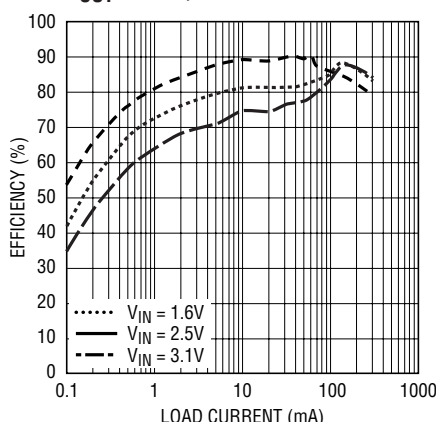

EFFICIENCY
 $V_{IN} = 1.6V$
 ——— $V_{IN} = 2.5V$
 - - - $V_{IN} = 3.1V$

Efficiency vs Load Current, $V_{OUT} = 1.2V$, Pulse Skip

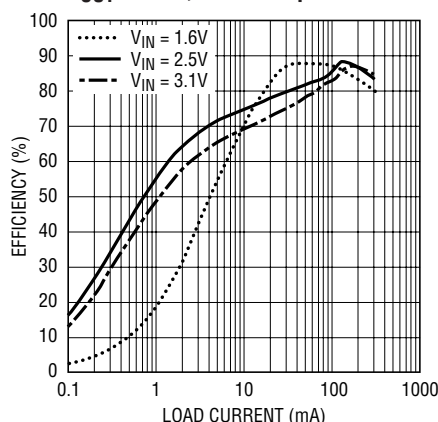

EFFICIENCY
 $V_{IN} = 1.6V$
 ——— $V_{IN} = 2.5V$
 - - - $V_{IN} = 3.1V$

Reference Voltage vs Temperature

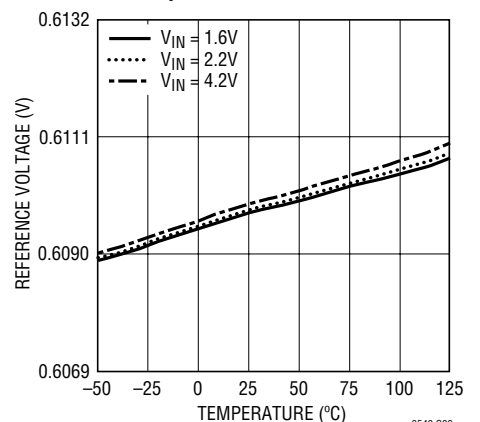

REFERENCE VOLTAGE (V)
 ——— $V_{IN} = 1.6V$
 $V_{IN} = 2.2V$
 - - - $V_{IN} = 4.2V$

TYPICAL PERFORMANCE CHARACTERISTICS

(From Typical Application on the front page, except for the resistive divider resistor values)

Oscillator Frequency vs Temperature

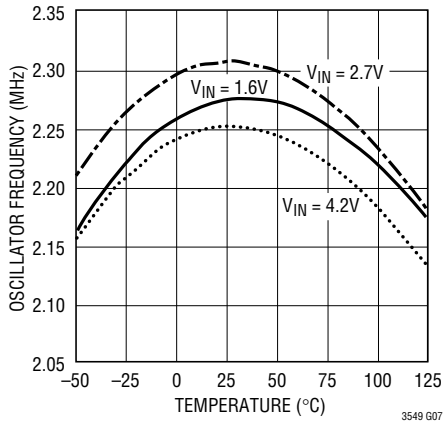

Oscillator Frequency Shift vs Input Voltage

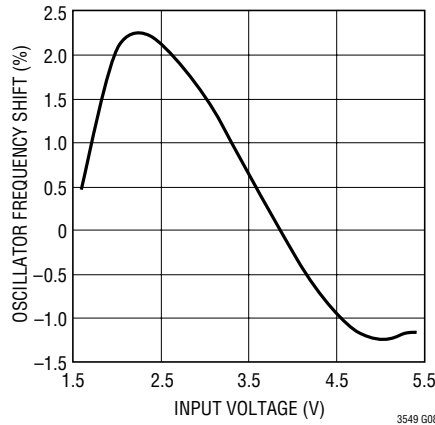

Output Voltage vs Load Current
VIN = 1.6V, VOUT = 1.2V

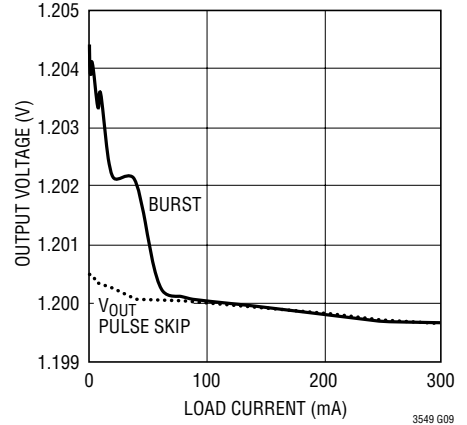

RDS(ON) vs Input Voltage

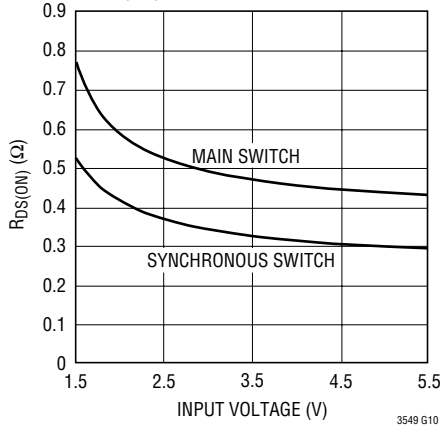

RDS(ON) vs Temperature

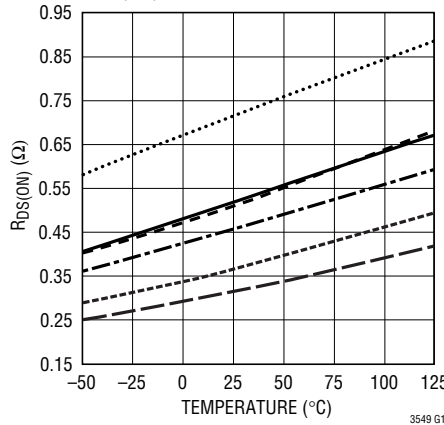

Dynamic Input Current
VOUT = 1.5V, 247kΩ Load

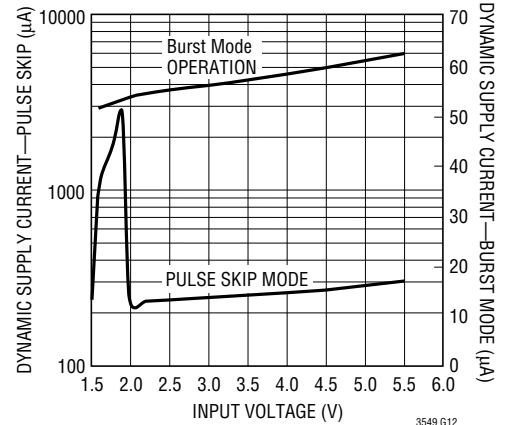

Dynamic Supply Current vs Temperature, VIN = 3.6V, VOUT = 1.5V, No Load

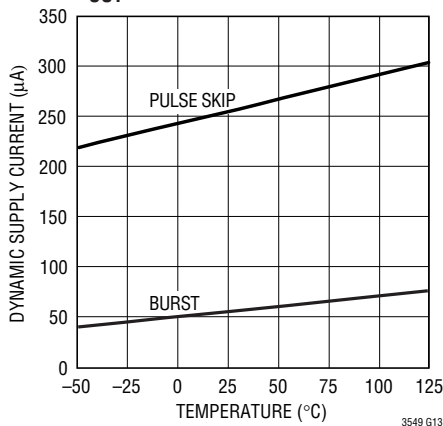

Switch Leakage vs Temperature
VIN = 5.5V

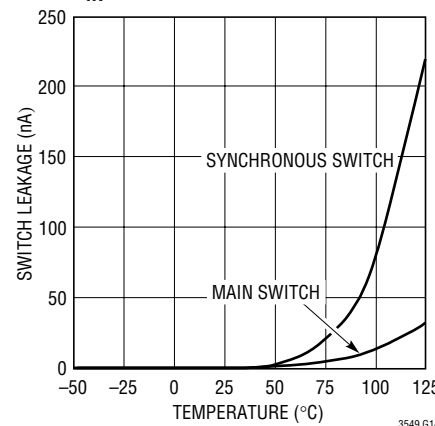

Switch Leakage vs Input Voltage

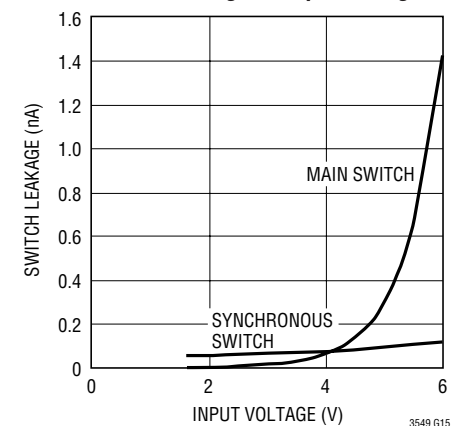

TYPICAL PERFORMANCE CHARACTERISTICS

(From Typical Application on the front page, except for the resistive divider resistor values)

**Start-Up from Shutdown
Burst Mode Operation**

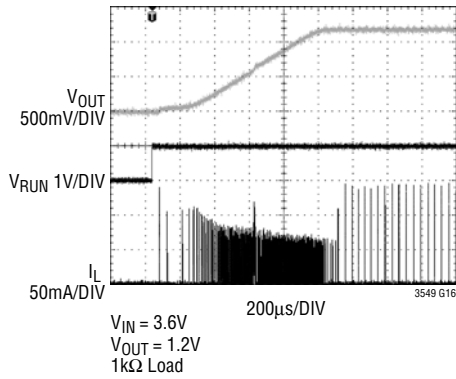

**Burst Mode Operation
 $I_{LOAD} = 20mA$**

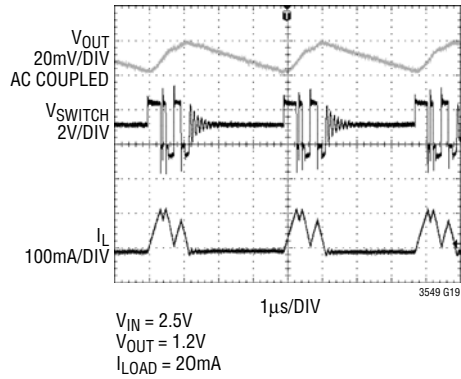

**Load Step 25mA to 250mA
Pulse Skip**

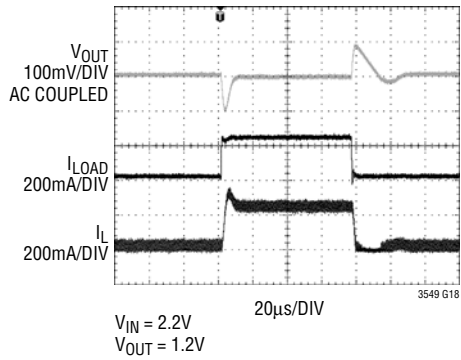

**Load Step 0mA to 250mA
Pulse Skip**

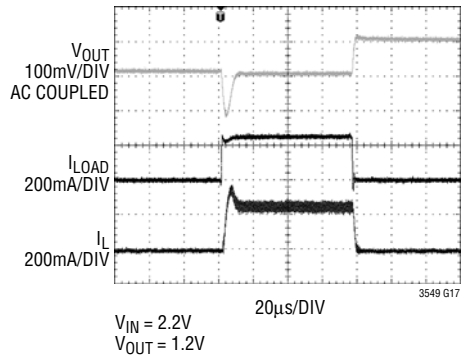

**Load Step 0mA to 250mA
Burst Mode Operation**

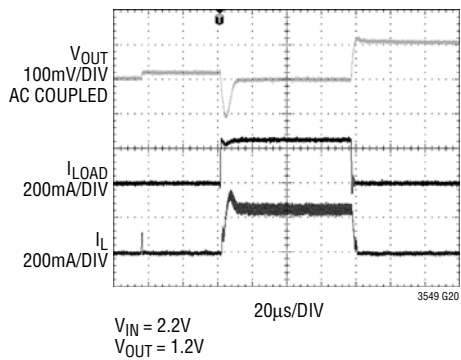

**Load Step 25mA to 250mA
Burst Mode Operation**

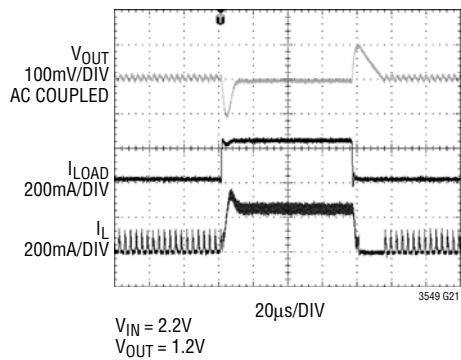

PIN FUNCTIONS

V_{IN} (Pin 1): Main Supply Pin. Must be closely decoupled to GND, Pins 2 and 7, with a 4.7 μ F or greater ceramic capacitor.

GND (Pin 2): N/C. Ground this pin.

SW (Pin 3): Switch Node Connection to Inductor. This pin connects to the drains of the internal main and synchronous power MOSFET switches.

MODE (Pin 4): Mode Select Input. To select pulse-skipping mode, force this pin above 1.1V. Forcing this pin below 0.3V selects Burst Mode operation. Do not leave MODE floating.

RUN (Pin 5): Run Control Input. Forcing this pin above 1.1V enables the part. Forcing this pin below 0.3V shuts down the device. In shutdown, all functions are disabled drawing <math><1\mu\text{A}</math> supply current. Do not leave RUN floating.

V_{FB} (Pin 6): Feedback Pin. Receives the feedback voltage from an external resistive divider across the output.

GND (Pin 7): Exposed Pad. The Exposed Pad is ground. It must be soldered to PCB ground to provide both electrical contact and optimum thermal performance.

FUNCTIONAL DIAGRAM

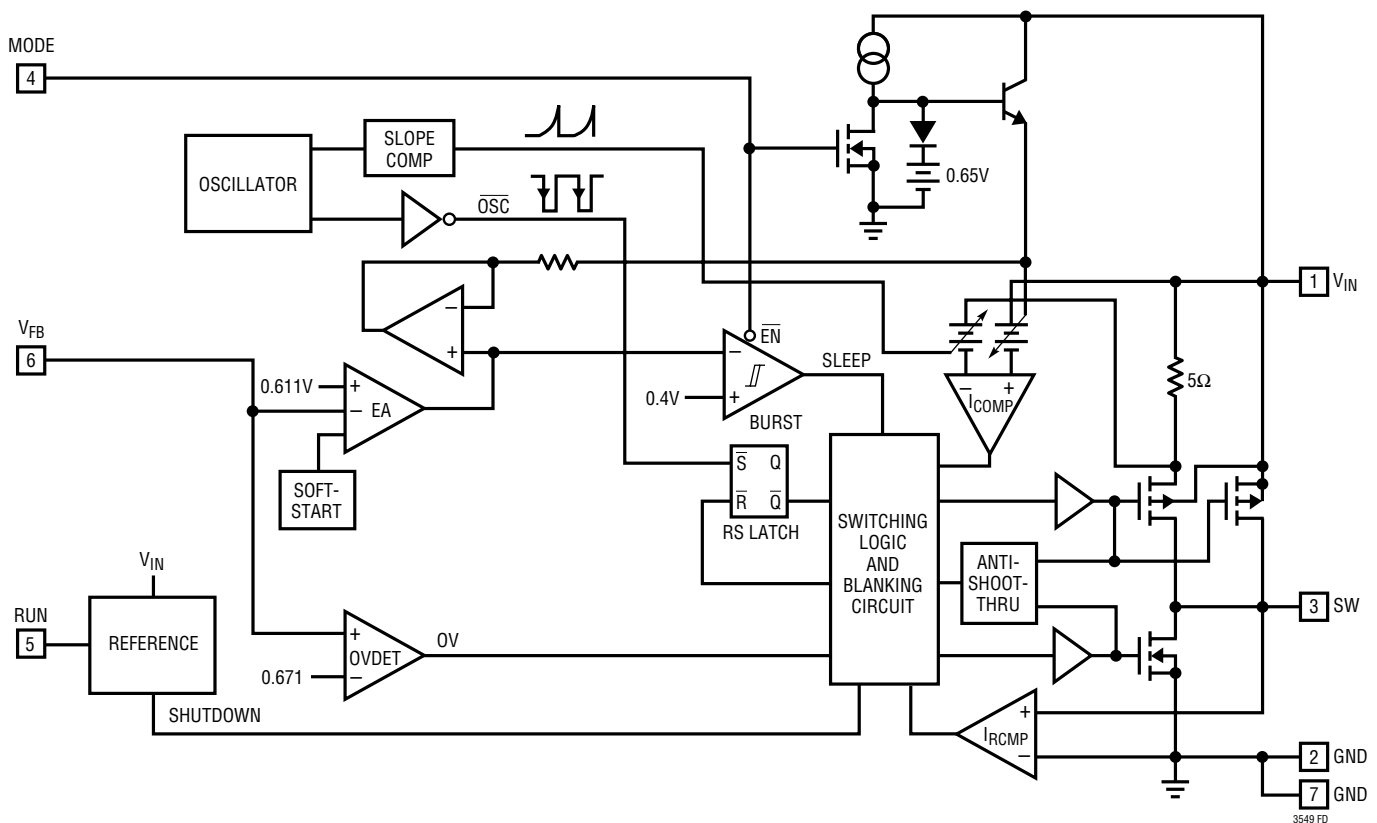

OPERATION

Main Control Loop

The LTC3549 uses a constant-frequency, current mode step-down architecture. Both the main (P-channel MOSFET) and synchronous (N-channel MOSFET) switches are internal. During normal operation, the internal top power MOSFET is turned on each cycle when the oscillator sets the RS latch, and turned off when the current comparator, I_{COMP} , resets the RS latch. The peak inductor current at which I_{COMP} resets the RS latch is controlled by the output of error amplifier EA. The V_{FB} pin, described in the Pin Functions section, allows EA to receive an output feedback voltage from an external resistive divider. When the load current increases, it causes a slight decrease in the feedback voltage relative to the 0.611V reference, which in turn, causes the EA amplifier's output voltage to increase until the average inductor current matches the new load current. While the top MOSFET is off, the bottom MOSFET is turned on until either the inductor current starts to reverse, as indicated by the current reversal comparator I_{RCMP} , or the beginning of the next clock cycle.

Comparator OVDET guards against transient overshoots >10% by turning the main switch off and keeping it off until the transient has ended.

Burst Mode Operation

The LTC3549 is capable of Burst Mode operation in which the internal power MOSFETs operate intermittently based on load demand. To enable Burst Mode operation, simply connect the MODE pin to GND. To disable Burst Mode operation and enable PWM pulse-skipping mode, connect the MODE pin to V_{IN} or drive it with a logic high ($V_{MODE} > 1.1V$). In this mode, the efficiency is lower at light loads, but becomes comparable to Burst Mode operation when the output load exceeds 50mA. The advantage of pulse-skipping mode is lower output ripple and less interference to audio circuitry. When the converter is in Burst Mode operation, the minimum peak current of the inductor is set to approximately 100mA regardless of the output load. Each burst event can last from a few cycles at light loads to almost continuously cycling with short sleep intervals at moderate loads. In between these burst events, the power MOSFETs and any unneeded circuitry are turned off, reducing the quiescent current to 50 μ A. In this sleep

state, the load current is being supplied solely from the output capacitor. As the output voltage droops, the EA amplifier's output rises above the sleep threshold signaling the BURST comparator to trip and turn the top MOSFET on. This process repeats at a rate that is dependent on the load demand.

Short-Circuit Protection

When the output is shorted to ground the LTC3549 limits the synchronous switch current to 0.45A. If this limit is exceeded, the top power MOSFET is inhibited from turning on until the current in the synchronous switch falls below 0.45A.

Dropout Operation

As the input supply voltage decreases to a value approaching the output voltage, the duty cycle increases toward the maximum on-time. Further reduction of the supply voltage forces the main switch to remain on for more than one cycle until it reaches 100% duty cycle. The output voltage will then be determined by the input voltage minus the voltage drop across the P-channel MOSFET and the inductor.

Another important detail to remember is that at low input supply voltages, the $R_{DS(ON)}$ of the P-channel switch increases (see Typical Performance Characteristics). Therefore, the user should calculate the power dissipation when the LTC3549 is used at 100% duty cycle with low input voltage (see Thermal Considerations in the Applications Information section).

Slope Compensation

Slope compensation provides stability in constant-frequency architectures by preventing subharmonic oscillations at high duty cycles. It is accomplished internally by adding a compensating ramp to the inductor current signal at duty cycles in excess of 40%.

Internal Soft-Start

At start-up when the RUN pin is brought high, the internal reference is linearly ramped from 0V to 0.611V in 1ms. The regulated feedback voltage will follow this ramp, resulting in the output voltage ramping from 0% to 100% in 1ms. The average current in the inductor during soft-start will

OPERATION

be defined by the combination of the current needed to charge the output capacitance and the current provided to the load as the output voltage ramps up. The start-up

waveform, shown in the Typical Performance Characteristics, shows the output voltage start-up from 0V to 1.2V with a 1k Ω load and $V_{IN} = 3.6V$.

APPLICATIONS INFORMATION

The basic LTC3549 application circuit is shown on the first page of this data sheet. External component selection is driven by the load requirement and begins with the selection of L followed by C_{IN} and C_{OUT} .

Inductor Selection

For most applications, the value of the inductor will fall in the range of 1 μ H to 10 μ H. Its value is chosen based on the desired ripple current. Large value inductors lower ripple current and small value inductors result in higher ripple currents. Higher V_{IN} or V_{OUT} also increases the ripple current as shown in Equation 1. A reasonable starting point for setting ripple current is $\Delta I_L = 100mA$ (40% of 250mA).

$$\Delta I_L = \frac{V_{OUT}}{f \cdot L} \left(1 - \frac{V_{OUT}}{V_{IN}} \right) \quad (1)$$

The DC current rating of the inductor should be at least equal to the maximum load current plus half the ripple current to prevent core saturation. Thus, a 300mA rated inductor should be enough for most applications (250mA + 50mA). For better efficiency, choose a low DC resistance inductor. The inductor value also has an effect on Burst Mode operation. The transition to low current operation begins when the inductor current peaks fall to approximately 100mA. Lower inductor values (higher ΔI_L) will cause this to occur at lower load currents, which can cause a dip in efficiency in the upper range of low current operation. In Burst Mode operation, lower inductance values will cause the burst frequency to increase.

Inductor Core Selection

Different core materials and shapes will change the size/current and price/current relationship of an inductor. Toroid or shielded pot cores in ferrite or permalloy

materials are small and don't radiate much energy, but generally cost more than powdered iron core inductors with similar electrical characteristics. The choice of which style inductor to use often depends more on the price vs size requirements and any radiated field/EMI requirements than on what the LTC3549 requires to operate. Table 1 shows some typical surface mount inductors that work well in LTC3549 applications.

Table 1. Representative Surface Mount Inductors

MANUFACTURER	PART NUMBER	VALUE (μ H)	MAX DC CURRENT (A)	DCR	HEIGHT (mm)
Taiyo Yuden	LB2016T2R2M	2.2	315	0.13	1.6
	LB2012T2R2M	2.2	240	0.23	1.25
	LB2016T3R3M	3.3	280	0.2	1.6
	LB2016T4R7M	4.7	210	0.25	1.6
Panasonic	ELT5KT4R7M	4.7	950	0.2	1.2
Murata	LQH32CN4R7M34	4.7	450	0.2	2
TDK	VLF3012AT2R2M1R0	2.2	1	0.088	1.2
	VLF3012AT3R3MR87	3.3	0.87	0.11	1.2
	VLF3012AT4R7MR74	4.7	0.74	0.16	1.2
	VLF3010AT2R2M1R0	2.2	1	0.10	1.0
	VLF3010AT3R3MR87	3.3	0.87	0.15	1.0
	VLF3010AT4R7MR70	4.7	0.74	0.24	1.0

C_{IN} and C_{OUT} Selection

In continuous mode, the source current of the top MOSFET is a square wave of duty cycle V_{OUT}/V_{IN} . To prevent large voltage transients, a low ESR input capacitor sized for the maximum RMS current must be used. The maximum RMS capacitor current is given by:

$$C_{IN} \text{ Required } I_{RMS} \cong I_{OUT(MAX)} \frac{[V_{OUT}(V_{IN} - V_{OUT})]^{1/2}}{V_{IN}}$$

This formula has a maximum at $V_{IN} = 2V_{OUT}$, where $I_{RMS} = I_{OUT}/2$. This simple worst-case condition is commonly used for design because even significant devia-

APPLICATIONS INFORMATION

tions do not offer much relief. Note that the capacitor manufacturer's ripple current ratings are often based on 2000 hours of life. This makes it advisable to further derate the capacitor, or choose a capacitor rated at a higher temperature than required. Always consult the manufacturer if there is any question. The selection of C_{OUT} is driven by the required effective series resistance (ESR). Typically, once the ESR requirement for C_{OUT} has been met, the RMS current rating generally far exceeds the $I_{RIPPLE(P-P)}$ requirement. The output ripple ΔV_{OUT} is determined by:

$$\Delta V_{OUT} = \Delta I_L \left(ESR + \frac{1}{8 \cdot f \cdot C_{OUT}} \right)$$

where f = operating frequency, C_{OUT} = output capacitance and ΔI_L = ripple current in the inductor. For a fixed output voltage, the output ripple is highest at maximum input voltage since ΔI_L increases with input voltage. Aluminum electrolytic and dry tantalum capacitors are both available in surface mount configurations. In the case of tantalum, it is critical that the capacitors are surge tested for use in switching power supplies. An excellent choice is the AVX TPS series of surface mount tantalum. These are specially constructed and tested for low ESR so they give the lowest ESR for a given volume. Other capacitor types include Sanyo POSCAP, Kemet T510 and T495 series, and Sprague 593D and 595D series. Consult the manufacturer for other specific recommendations.

Using Ceramic Input and Output Capacitors

The LTC3549 typically will require an output capacitor in the 4.7 μ F to 10 μ F range for optimum stability. Higher

value, lower cost ceramic capacitors are now available in smaller case sizes. Their high ripple current, high voltage rating and low ESR make them ideal for switching regulator applications. Because the LTC3549's control loop does not depend on the output capacitor's ESR for stable operation, ceramic capacitors can be used to achieve very low output ripple and small circuit size.

However, care must be taken when these capacitors are used at the input and the output. When a ceramic capacitor is used at the input and the power is supplied by a wall adapter through long wires, a load step at the output can induce ringing at the input, V_{IN} . At best, this ringing can couple to the output and be mistaken as loop instability. At worst, a sudden inrush of current through the long wires can potentially cause a voltage spike at V_{IN} , large enough to damage the part.

When choosing the input and output ceramic capacitors, choose the X5R or X7R dielectric formulations. These dielectrics have the best temperature and voltage characteristics of all the ceramics for a given value and size.

Output Voltage Programming

The output voltage is set by a resistive divider according to the following formula:

$$V_{OUT} = 0.611V \left(1 + \frac{R1}{R2} \right) \quad (2)$$

The external resistive divider is connected to the output, allowing remote voltage sensing as shown in Figure 1

Table 2 gives 1% resistor values for selected output voltages.

Table 2. Resistor Values for Selected Output Voltages

V_{OUT}	R1	R2
0.85V	53.6k	137k
1.2V	133k	137k
1.5V	200k	137k
1.8V	267k	137k

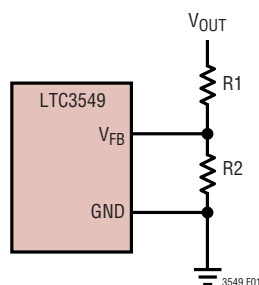

Figure 1. Setting the LTC3549 Output Voltage

APPLICATIONS INFORMATION

Efficiency Considerations

The efficiency of a switching regulator is equal to the output power divided by the input power times 100%. It is often useful to analyze individual losses to determine what is limiting the efficiency and which change would produce the most improvement. Efficiency can be expressed as:

$$\text{Efficiency} = 100\% - (L1 + L2 + L3 + \dots)$$

where L1, L2, etc. are the individual losses as a percentage of input power.

Although all dissipative elements in the circuit produce losses, two main sources usually account for most of the losses in LTC3549 circuits: V_{IN} quiescent current and I^2R losses. The V_{IN} quiescent current loss dominates the efficiency loss at very low load currents whereas the I^2R loss dominates the efficiency loss at medium to high load currents. In a typical efficiency plot, the efficiency curve at very low load currents can be misleading since the actual power lost is of no consequence, as illustrated in Figure 2.

1. The V_{IN} quiescent current is due to two components: the DC bias current as given in the Electrical Characteristics and the internal main switch and synchronous switch gate charge currents. The gate charge current results from switching the gate capacitance of the internal power MOSFET switches. Each time the gate is switched from

high to low to high again, a packet of charge, dQ , moves from V_{IN} to ground. The resulting dQ/dt is the current out of V_{IN} that is typically larger than the DC bias current. In continuous mode, $I_{GATECHG} = f(Q_T + Q_B)$ where Q_T and Q_B are the gate charges of the internal top and bottom switches. Both the DC bias and gate charge losses are proportional to V_{IN} and thus their effects will be more pronounced at higher supply voltages.

2. I^2R losses are calculated from the resistances of the internal switches, R_{SW} , and external inductor R_L . In continuous mode, the average output current flowing through inductor L is “chopped” between the main switch and the synchronous switch. Thus, the series resistance looking into the SW pin is a function of both top and bottom MOSFET $R_{DS(ON)}$ and the duty cycle (DC) as follows:

$$R_{SW} = (R_{DS(ON)TOP})(DC) + (R_{DS(ON)BOT})(1 - DC)$$

The $R_{DS(ON)}$ for both the top and bottom MOSFETs can be obtained from the Typical Performance Characteristics. Thus, to obtain I^2R losses, simply add R_{SW} to R_L and multiply the result by the square of the average output current.

Other losses including C_{IN} and C_{OUT} ESR dissipative losses and inductor core losses generally account for less than 2% total additional loss.

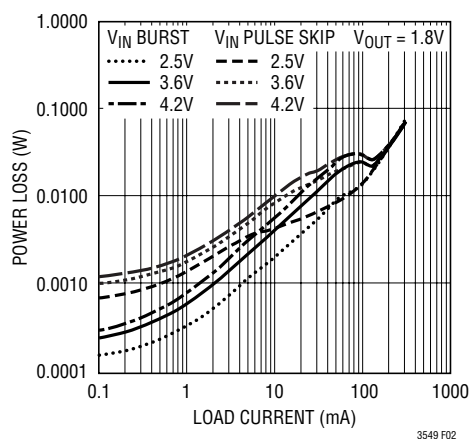

Figure 2. Power Loss vs Load Current

APPLICATIONS INFORMATION

Thermal Considerations

In most applications the LTC3549 does not dissipate much heat due to its high efficiency. But, in applications where the LTC3549 is running at high ambient temperature with low supply voltage and high duty cycles, such as in dropout, the heat dissipated may exceed the maximum junction temperature of the part. If the junction temperature reaches approximately 150°C, both power switches will be turned off and the SW node will become high impedance.

To avoid the LTC3549 from exceeding the maximum junction temperature, the user will need to do a thermal analysis. The goal of the thermal analysis is to determine whether the operating conditions exceed the maximum junction temperature of the part. The temperature rise is given by:

$$T_R = (P_D)(\theta_{JA})$$

where P_D is the power dissipated by the regulator and θ_{JA} is the thermal resistance from the junction of the die to the ambient temperature.

The junction temperature, T_J , is given by:

$$T_J = T_A + T_R$$

where T_A is the ambient temperature.

As an example, consider the LTC3549 in dropout at an input voltage of 1.6V, a load current of 250mA and an ambient temperature of 75°C. In the Switch Resistance graph shown in the Typical Performance Characteristics, the $R_{DS(ON)}$ of the P-channel switch at 75°C is approximately 0.8Ω. Therefore, power dissipated by the part is:

$$P_D = I_{LOAD}^2 \cdot R_{DS(ON)} = 50mW$$

For the DCB6 package, the θ_{JA} is 64°C/W. Thus, the junction temperature of the regulator is:

$$T_J = 75^\circ\text{C} + (0.05)(64) = 78.2^\circ\text{C}$$

which is well below the maximum junction temperature of 125°C.

Note that at higher supply voltages, the junction temperature is lower due to reduced switch resistance ($R_{DS(ON)}$).

Checking Transient Response

The regulator loop response can be checked by looking at the load transient response. Switching regulators take several cycles to respond to a step in load current. When a load step occurs, V_{OUT} immediately shifts by an amount equal to $(\Delta I_{LOAD} \cdot ESR)$, where ESR is the effective series resistance of C_{OUT} . ΔI_{LOAD} also begins to charge or discharge C_{OUT} , which generates a feedback error signal. The regulator loop then acts to return V_{OUT} to its steady state value. During this recovery time V_{OUT} can be monitored for overshoot or ringing that would indicate a stability problem. For a detailed explanation of switching control loop theory, see Application Note 76.

A second, more severe transient is caused by switching in loads with large ($> 1\mu\text{F}$) supply bypass capacitors. The discharged bypass capacitors are effectively put in parallel with C_{OUT} , causing a rapid drop in V_{OUT} . No regulator can deliver enough current to prevent this problem if the load switch resistance is low and it is driven quickly. The only solution is to limit the rise time of the switch drive so that the load rise time is limited to approximately $(25 \cdot C_{LOAD})$. Thus, a 10μF capacitor charging to 3.3V would require a 250μs rise time, limiting the charging current to about 130mA.

APPLICATIONS INFORMATION

Board Layout Considerations

When laying out the printed circuit board, the following checklist should be used to ensure proper operation of the LTC3549. These items are also illustrated graphically in the layout diagram of Figure 3. Check the following in your layout.

1. Does the capacitor C_{IN} connect to the power V_{IN} (Pin 1) and GND (Pins 2, 7) as close as possible? This capacitor provides the AC current to the internal power MOSFETs and their drivers.
2. Are the C_{OUT} and L1 closely connected? The (-) plate of C_{OUT} returns current to GND and the (-) plate of C_{IN} .
3. The resistor divider, R1 and R2, must be connected between the (+) plate of C_{OUT} and a ground sense line terminated near GND (Exposed Pad). The feedback

signals V_{FB} should be routed away from noisy components and traces, such as the SW line (Pin 3), and its trace should be minimized.

4. Keep sensitive components away from the SW pins. The input capacitor C_{IN} and the resistors R1 and R2 should be routed away from the SW traces and the inductors.
5. A ground plane is preferred, but if not available, keep the signal and power grounds segregated with small signal components returning to the GND pin at one point. They should not share the high current path of C_{IN} or C_{OUT} .
6. Flood all unused areas on all layers with copper. Flooding with copper will reduce the temperature rise of power components. These copper areas should be connected to V_{IN} or G_{ND} .

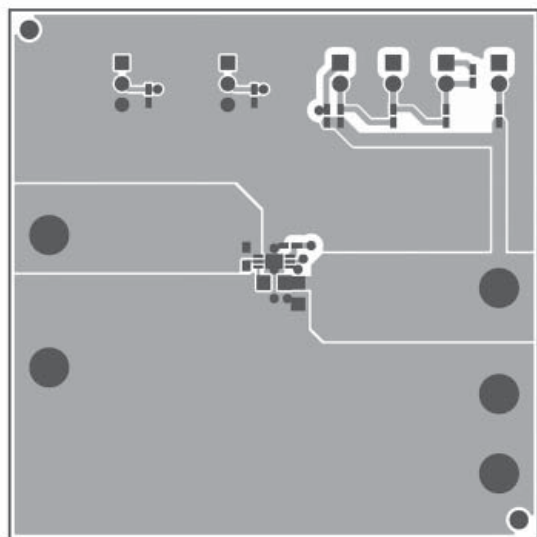

Figure 3a. Buck Regulator Top Layer

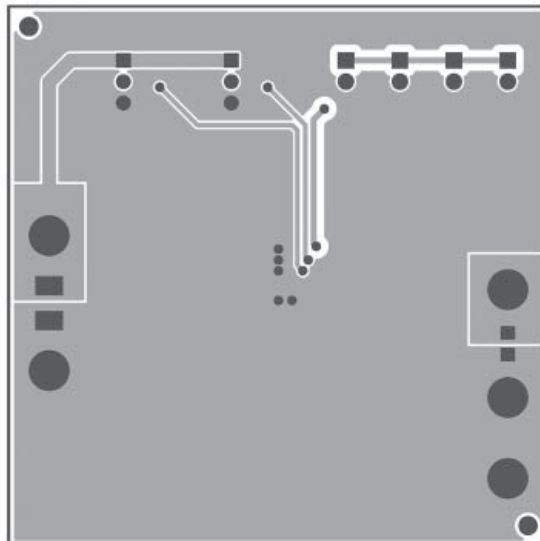

Figure 3b. Buck Regulator Bottom Layer

APPLICATIONS INFORMATION

Design Example

As a design example, assume the LTC3549 is used in a 2-alkaline cell battery-powered application. The V_{IN} will be operating from a maximum of 3.1V down to about 1.8V. The load current requirement is a maximum of 250mA but most of the time it will be in standby mode, requiring only 2mA. Efficiency at both low and high load currents is important. Output voltage is 1.5V. With this information we can calculate L using Equation 3:

$$L = \frac{V_{OUT}}{f \cdot \Delta I_L} \left(1 - \frac{V_{OUT}}{V_{IN}} \right) \quad (3)$$

Substituting $V_{OUT} = 1.5V$, $V_{IN} = 3.1V$, $\Delta I_L = 100mA$ and $f = 2.25MHz$ in Equation 3 gives:

$$L = \frac{1}{2.25MHz \cdot 100mA} 1.5 \left(1 - \frac{1.5}{3.1} \right) \cong 3.3\mu H$$

For best efficiency choose a 350mA or greater inductor with less than 0.3Ω series resistance. C_{IN} will require an RMS current rating of at least $0.125A \cong I_{LOAD(MAX)}/2$ at temperature.

For the feedback resistors, choose $R2 = 137k$. Then, from Equation 3, $R1$ is 200k. Figure 4 shows the complete circuit along with its efficiency curve.

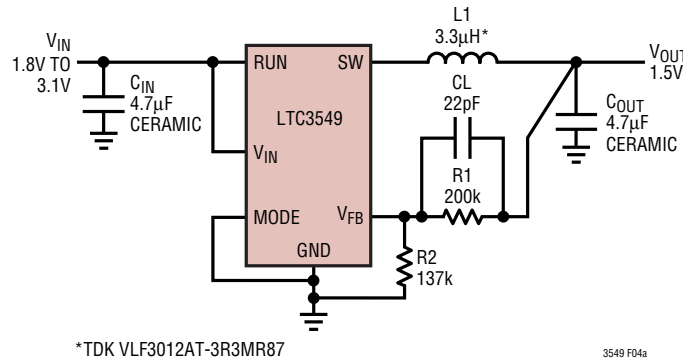

Figure 4a. High Efficiency Step-Down Regulator

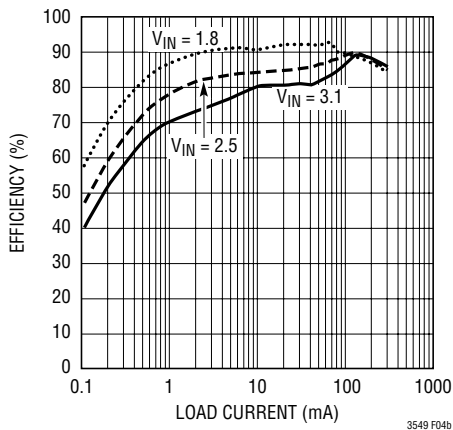

Figure 4b. Burst Mode Efficiency, $V_{OUT} = 1.5V$

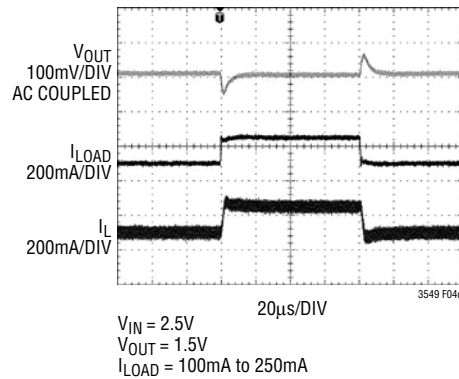
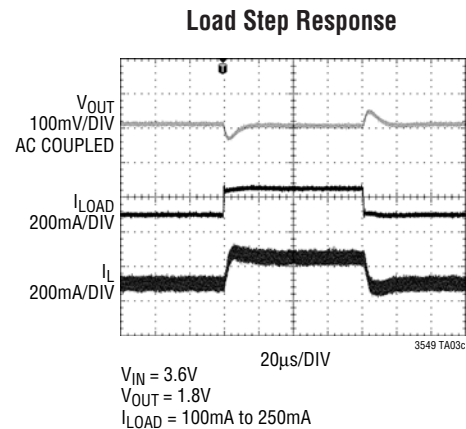
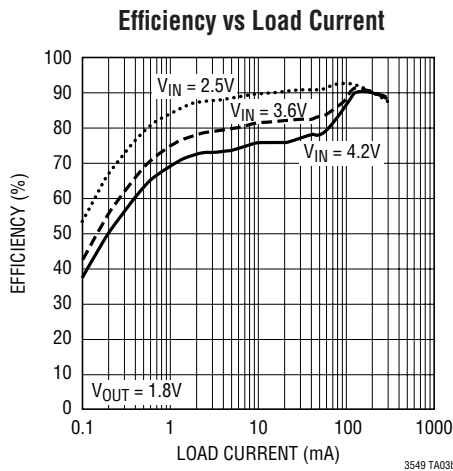
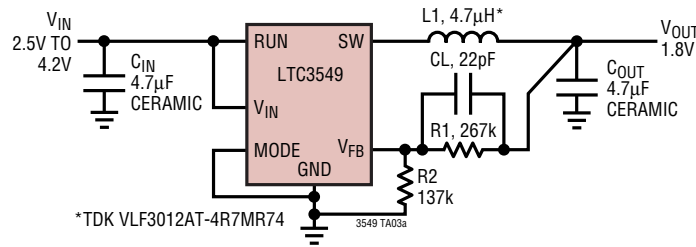

Figure 4c. Load Step Response

TYPICAL APPLICATION



RELATED PARTS

PART NUMBER	DESCRIPTION	COMMENTS
LTC1878	600mA (I_{OUT}), 550kHz, Synchronous Step-Down DC/DC Converter	96% Efficiency, V_{IN} : 2.7V to 6V, $V_{OUT(MIN)}$ = 0.8V, I_Q = 10µA, I_{SD} < 1µA, MS8 Package
LTC1879	1.20A (I_{OUT}), 550kHz, Synchronous Step-Down DC/DC Converter	95% Efficiency, V_{IN} : 2.7V to 10V, $V_{OUT(MIN)}$ = 0.8V, I_Q = 15µA, I_{SD} < 1µA, 16-Lead TSSOP
LT3020	100mA, Low Voltage VLDO™	V_{IN} : 0.9V to 10V, $V_{OUT(MIN)}$ = 0.20V, Dropout Voltage = 0.15V, I_Q = 120µA, I_{SD} < 3µA, V_{OUT} = ADJ, DFN/MS8 Packages
LTC3025	100mA, Low Voltage VLDO	V_{IN} : 0.9V to 5.5V, $V_{OUT(MIN)}$ = 0.40V, Dropout Voltage = 0.05V, I_Q = 54µA, I_{SD} < 1µA, V_{OUT} = ADJ, DFN Package
LTC3404	600mA (I_{OUT}), 1.4MHz, Synchronous Step-Down DC/DC Converter	96% Efficiency, V_{IN} : 2.7V to 6V, $V_{OUT(MIN)}$ = 0.8V, I_Q = 10µA, I_{SD} < 1µA, MS8 Package
LTC3405/LTC3405A	300mA (I_{OUT}), 1.5MHz, Synchronous Step-Down DC/DC Converter	95% Efficiency, V_{IN} : 2.5V to 5.5V, $V_{OUT(MIN)}$ = 0.8V, I_Q = 20µA, I_{SD} < 1µA, ThinSOT™ Package
LTC3406/LTC3406B	600mA (I_{OUT}), 1.5MHz, Synchronous Step-Down DC/DC Converter	96% Efficiency, V_{IN} : 2.5V to 5.5V, $V_{OUT(MIN)}$ = 0.6V, I_Q = 20µA, I_{SD} < 1µA, ThinSOT Package
LTC3407/LTC3407-2	Dual, 800mA (I_{OUT}), 2.25MHz, Synchronous Step-Down DC/DC Converter	95% Efficiency, V_{IN} : 2.5V to 5.5V, $V_{OUT(MIN)}$ = 0.6V, I_Q = 40µA, I_{SD} < 1µA, 10-Lead MSE Package
LTC3409	600mA, 2.6MHz Low V_{IN} , Synchronous Step-Down DC/DC Converter	95% Efficiency, V_{IN} : 1.6V to 5.5V, $V_{OUT(MIN)}$ = 0.6V, I_Q = 65µA, I_{SD} < 1µA, DFN Package
LTC3410/LTC3410B	300mA, 2.25MHz, Synchronous Step-Down DC/DC Converter	96% Efficiency, V_{IN} : 2.5V to 5.5V, $V_{OUT(MIN)}$ = 0.8V, I_Q = 26µA/200µA, I_{SD} < 1µA, SC70 Package
LTC3411	1.25A (I_{OUT}), 4MHz, Synchronous Step-Down DC/DC Converter	95% Efficiency, V_{IN} : 2.5V to 5.5V, $V_{OUT(MIN)}$ = 0.8V, I_Q = 60µA, I_{SD} < 1µA, 10-Lead MS Package

VLDO and ThinSOT are trademarks of Linear Technology Corporation.