

RoHS

Specification

规格书

Customer Name:

客户名称: _____

Customer P/N:

客户品号: _____

Factory P/N:

公司品号: GCS0562FW2A5BD-6.3

Sending Date:

送样日期: _____

Client approval 客户审核			Goozo approval 鸿利国泽审核		
Approval 核准	Audit 确认	Confirmation 制作	Approval 核准	Audit 确认	Confirmation 制作
			潘桂建	赵丹	夏昊
<input type="checkbox"/> Qualified 接受		<input type="checkbox"/> Disqualified 不接受	DATE: 日期:		

Address: Dangui Road NO. 1 Dantu Area Zhenjiang City Jiangsu Province

地址: 江苏省镇江市丹徒区丹桂路 1 号

Tel/电话: 0511-88786599

Fax/传真: 0511-88786599

Web/网址: www.goozo.com.cn

注:

- 1.此规格书以中英文方式书写,若有冲突以中文版本为准文本.
- 2.此规格书的最终解释权归属江苏鸿利国泽光电科技有限公司





ATTENTION 注意
 OBSERVE PRECAUTIONS
 FOR HANDLING
 ELECTROSTATIC
 DISCHARGE
 SENSITIVE
 DEVICES

Features

- 0.56" Two Numeric Display
- White emitting, low power consumption, long life span
- Black -faced white plastic, Common Anode Show
- Complied With RoHS Directive
- Widely used in all kinds of household appliances, instruments and meters.

Package Dimensions

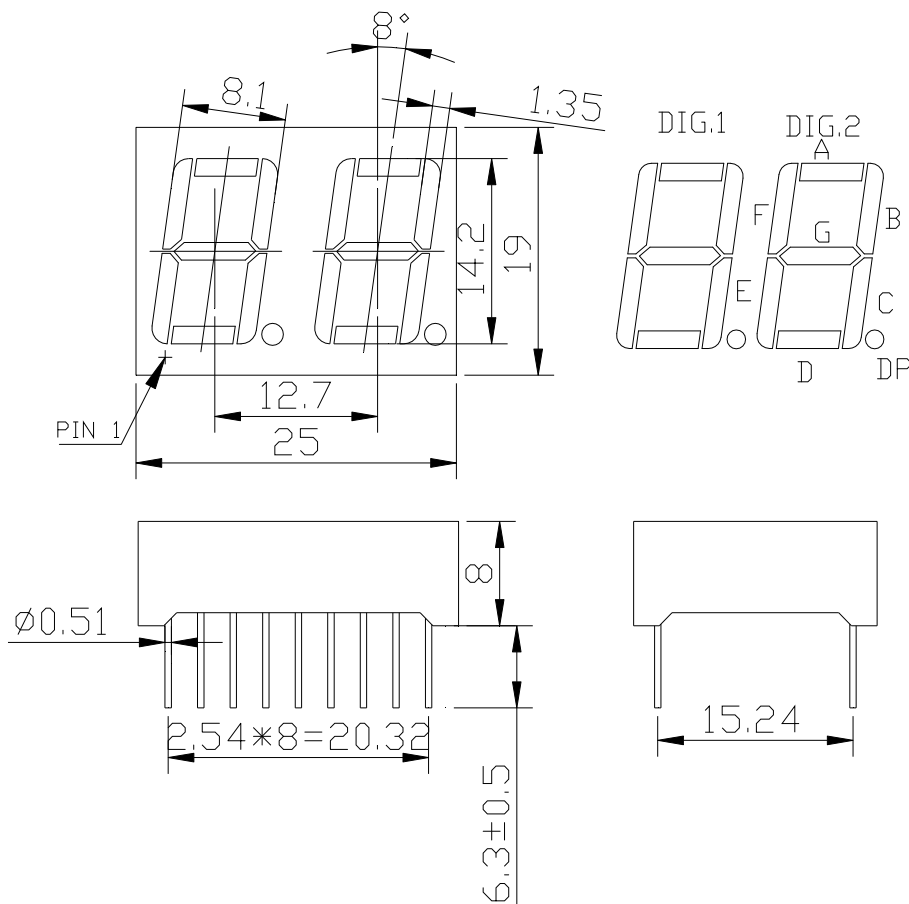

Unmarked tolerance : ± 0.25
 Unit : mm

Internal Circuit Diagram

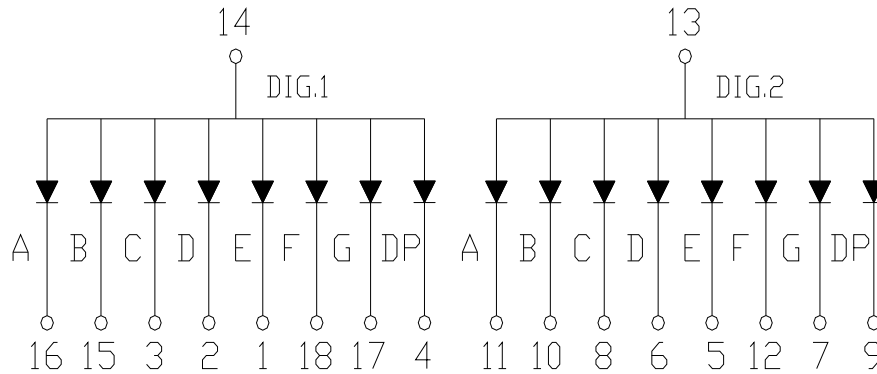

Absolute Maximum Rating

Item 项目	Symbol 符号	Value 数值	Unit 单位
Forward Current 正向电流	IF	20	mA/Seg
Peak Forward Current* 峰值正向电流	IFP	60	mA/Seg
Reverse Voltage 反向电压	VR	5	V/Seg
Power Dissipation 功耗	PD	60	mW/Seg
Operation Temperature 操作温度	Topr	-25~+60	°C
Storage Temperature 储存温度	Tstg	-25~+85	°C
Lead Soldering Temperature* 引脚焊接温度	Tsol	Max. 260°C for 5sec Max.	

*IFP Conditions: Pulse Width≤10msec /IFP 正向峰值电流使用条件: 脉冲宽度≤10 毫秒

Typical Optical/ Electrical Characteristics Ta=25°C

Item/项目	Symbol/符号	Condition/条件	Rank/档次	Min. 最小值	Typ. 典型值	Max. 最大值	Unit 单位
Luminous Intensity/光强	Iv	IF=5mA		150		300	mcd
Forward Voltage/正向电压	VF			2.4	3.0	3.4	V
Chromaticity Coordinates/色坐标	X			0.21	0.25	0.29	nm
	Y			0.19	0.23	0.27	nm
Reverse Current/反向电流	IR	Vr=5V		--	--	50	uA

Notes/注释:

Tolerance : VF±0.1V, λd±1 nm, IV(φV) ±15%, X/Y±0.005.

公差: 正向电压±0.1V, 主波长±1 nm, 光强 (光通量) ±15%, X/Y±0.005.

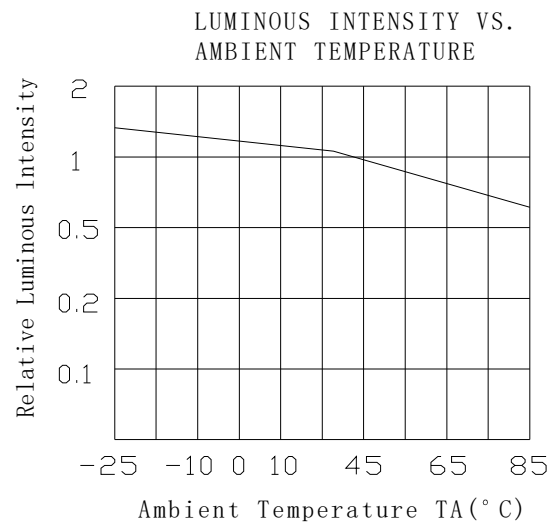
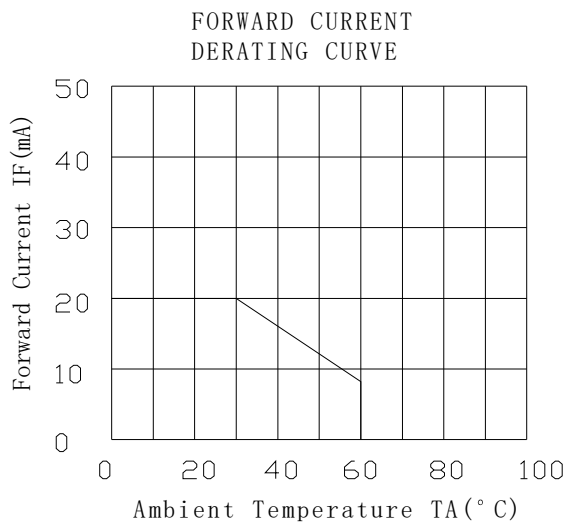
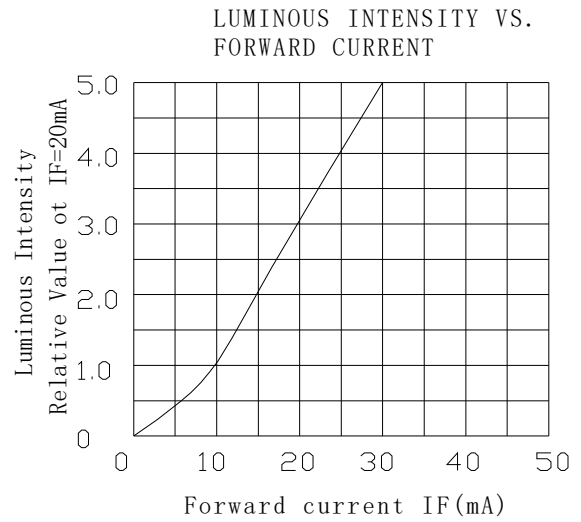
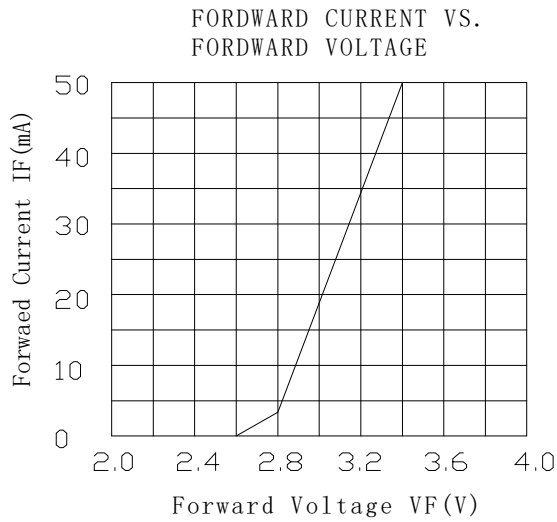
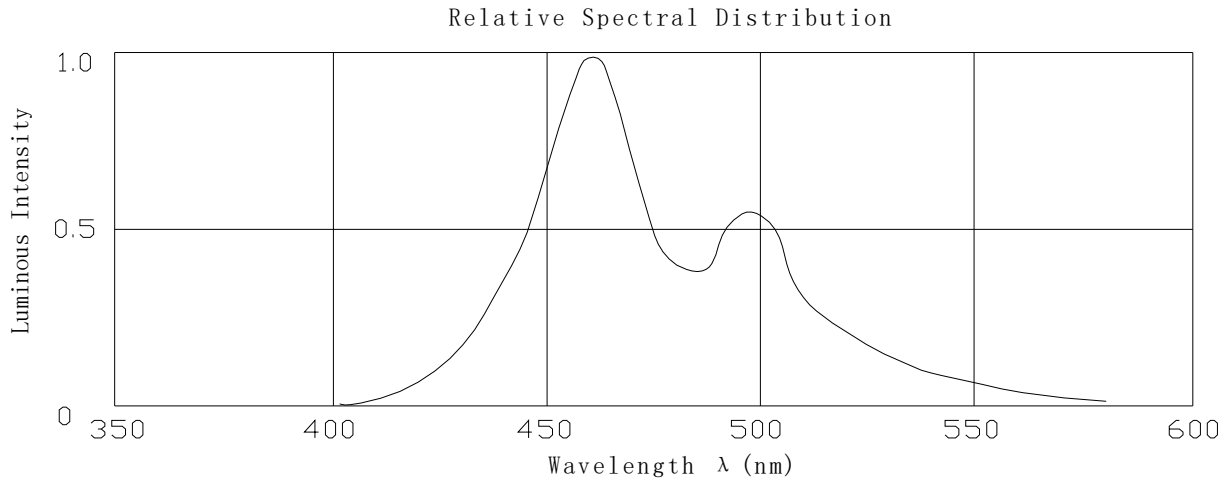

8、Precautions:

- ✧ Static electricity: This product is based on LED design, LED is sensitive to static electricity, static electricity and surge will cause LED characteristics to change, such as forward voltage reduction, etc., if the situation is serious, or even destroy products. So do not touch the pin directly. When installing or using, the relevant equipment and machine should be properly grounded, and other measures must be taken to prevent static electricity and surge. The use of antistatic bracelets, anti-static mats, antistatic work clothes, working shoes, gloves and anti-static containers are effective measures to prevent static electricity and surge.
- ✧ Storage: attention should be paid to preservation. If the preservation condition is not good, the adhesion force between the reflecting film and the reflecting cavity will be reduced. The recommended storage conditions are: temperature (25 ± 10), humidity (65 ± 20)%RH.
- ✧ Welding: the welding temperature is 260 and 5 C, the welding time is less than 3 seconds, the welding power is less than 30W, and the welding point should be more than 1.6mm.