

DETAILS

Product Number	CA10932_FLARE-B
Family	Flare
Type	Assembly
Color	clear
Diameter	29 x 22,8 mm
Height	12,84 mm
Style	rectang
Optic Material	PMMA
Holder Material	
Fastening	tape, screw
Status	production ready
ROHS Compliant	Yes
Date Updated	21/12/2016



OPTICAL PROPERTIES

LED	Viewing Angle	Light Beam	Efficiency	cd/lm	Connector
XP-E	102+10 deg	REC-class	93 %	1.750	-
XP-G	118+15 deg	REC-class	93 %	1.000	-
XB-D	10+108 deg	REC-class	93 %	1.520	-
XP-E2	11+101 deg	REC-class	94 %	2.300	-
LUXEON Rebel	101+14 deg	REC-class	93 %	1.700	-
LUXEON Rebel ES	12+104 deg	REC-class	94 %	1.370	-
LUXEON T	13+105 deg	REC-class	93 %	1.500	-
LUXEON H50-2	sim: 13+90	REC-class	sim: 95 %	sim: 2.100	-
LUXEON TX	14+114 deg	REC-class	93 %	1.600	-
NCSxx19A	9+88 deg	REC-class	94 %	2.040	-
NCSxx19B	11+103 deg	REC-class	94 %	1.850	-
NVSxx19B/NVSxx19C	14+110 deg	REC-class	96 %	1.600	-
Oslon SSL 80	83+11 deg	REC-class	93 %	2.200	-
Oslon SSL 150	9+117 deg	REC-class	93 %	1.600	-
Oslon Square EC	12+104 deg	REC-class	-	-	-
Z5	12+96 deg	REC-class	-	-	-
Double Dome (GM2BB)	104+10 deg	REC-class	-	-	-

Relative intensity of CA10932_FLARE-B_(XP-E)

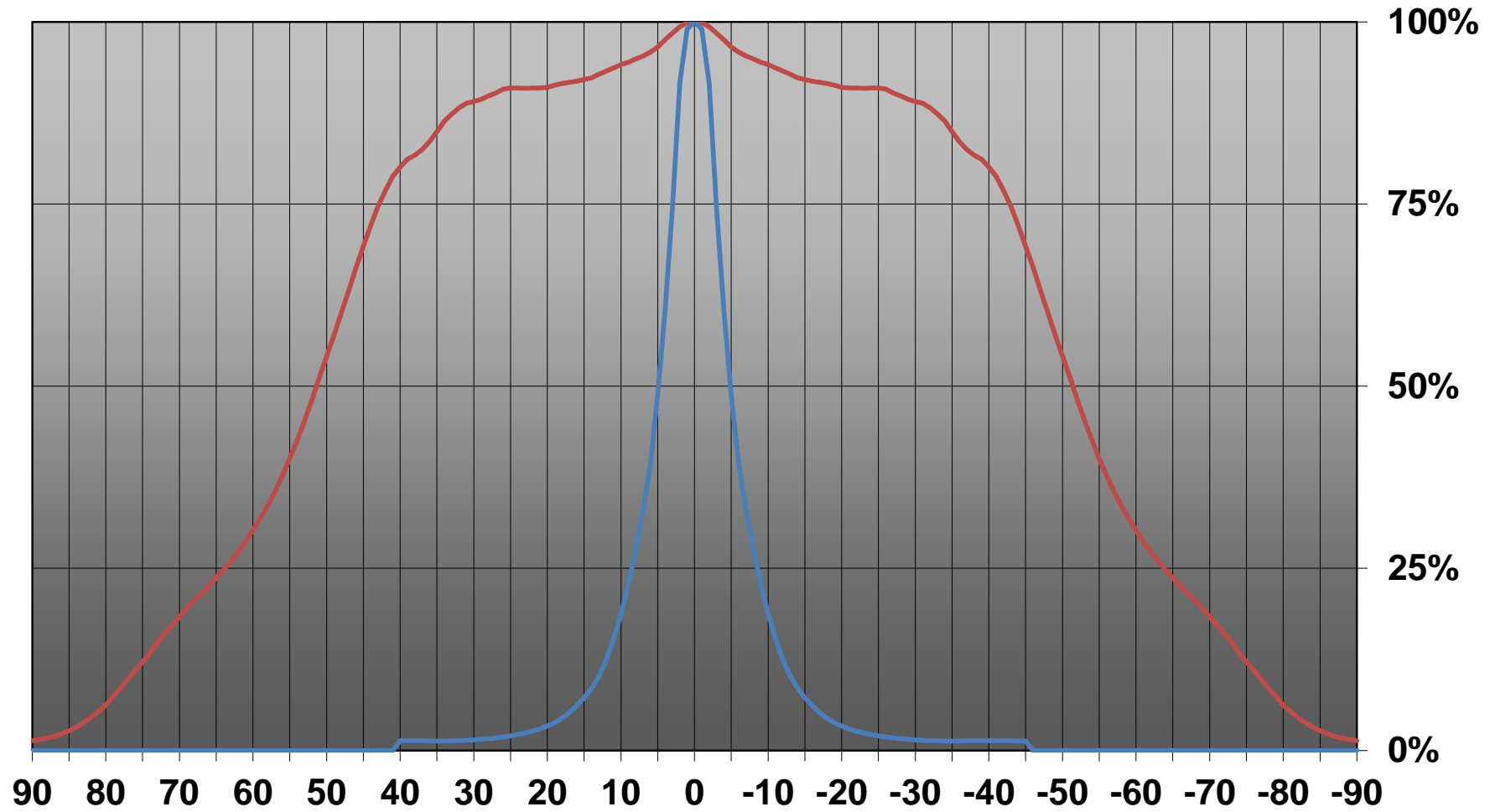

Relative intensity of CA10932_FLARE-B_(NCSxx19A)

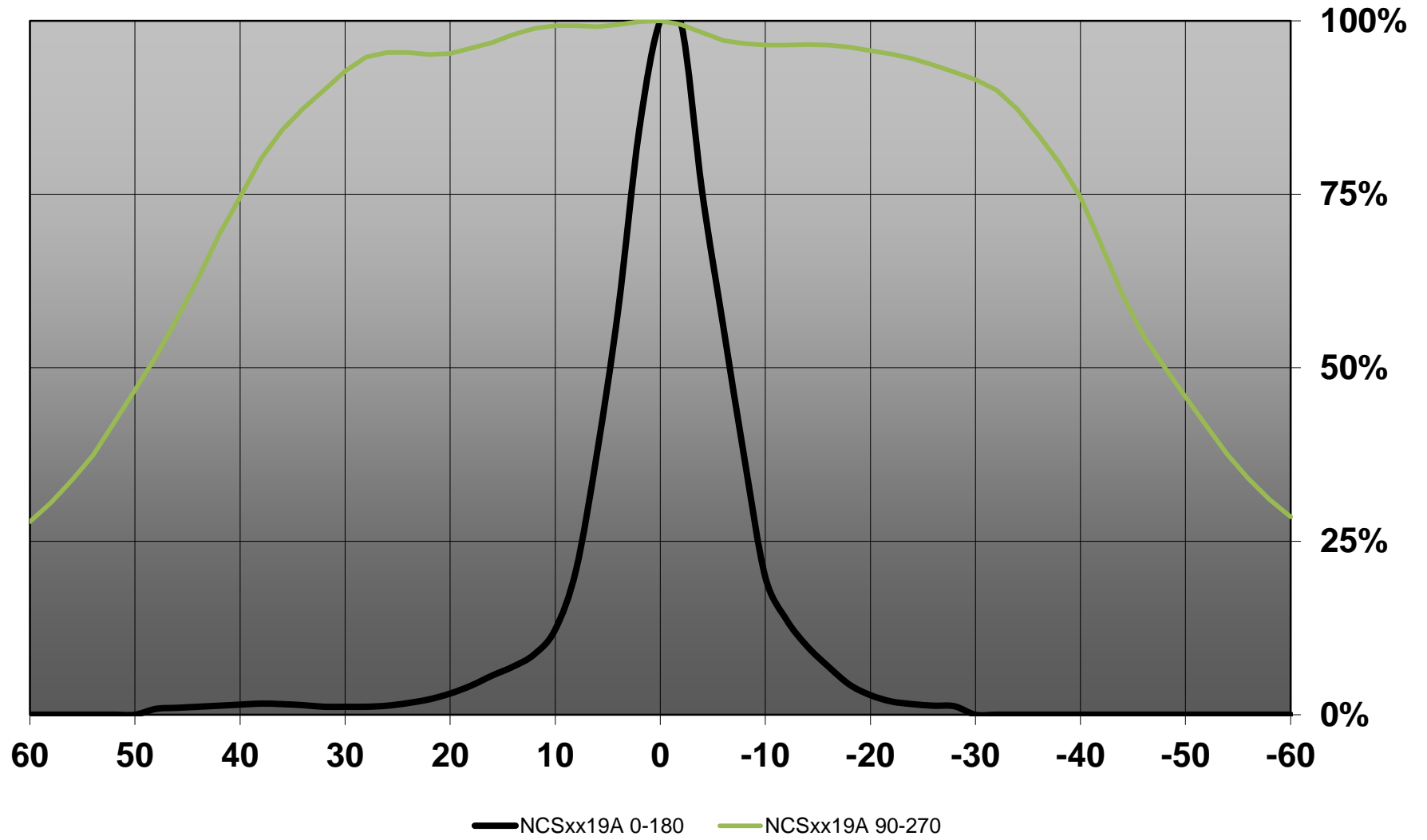

Relative intensity of CA10932_FLARE-B_(NCSxx19B)

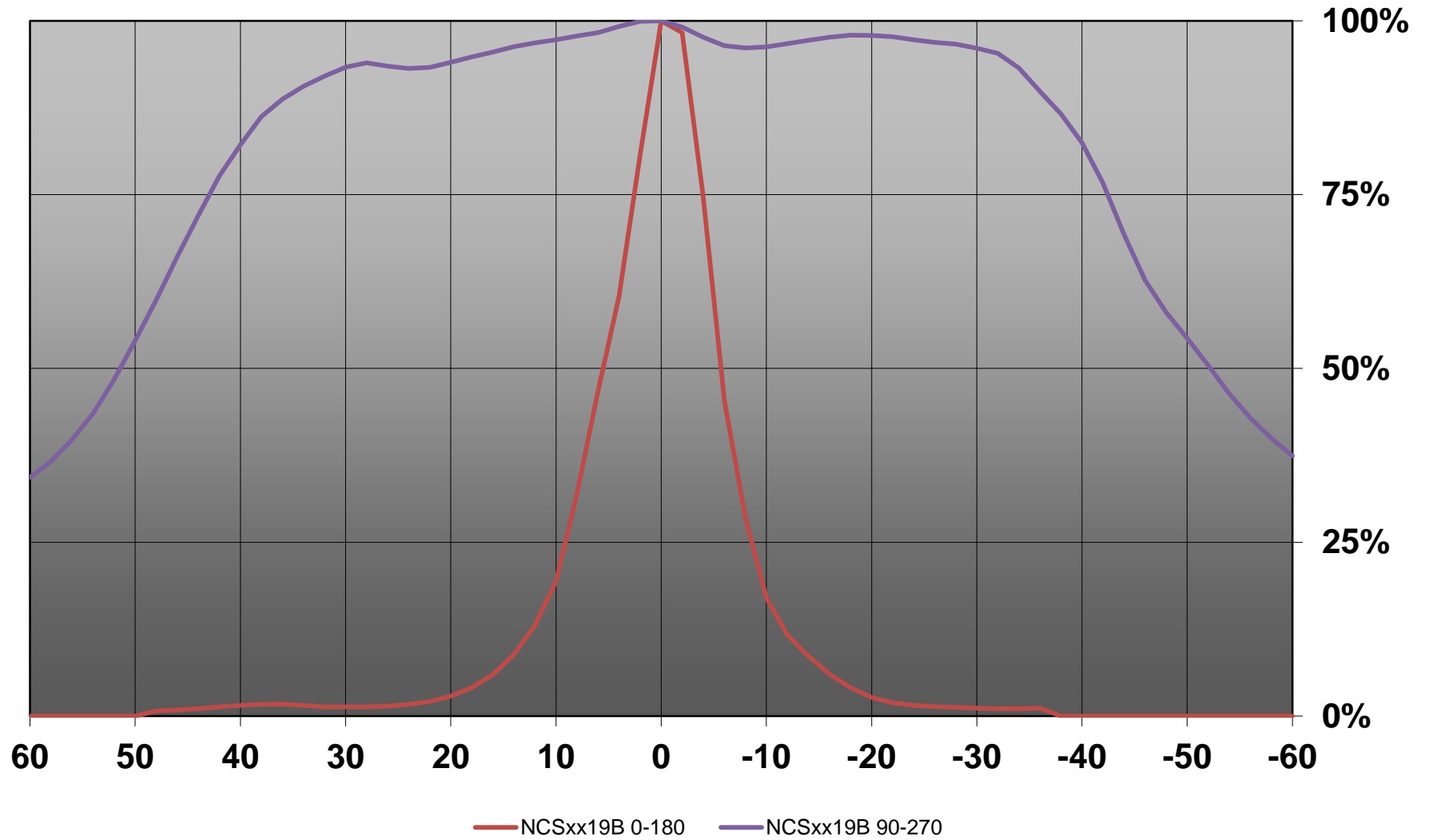

Relative intensity of CA10932_FLARE-B (OSL150)

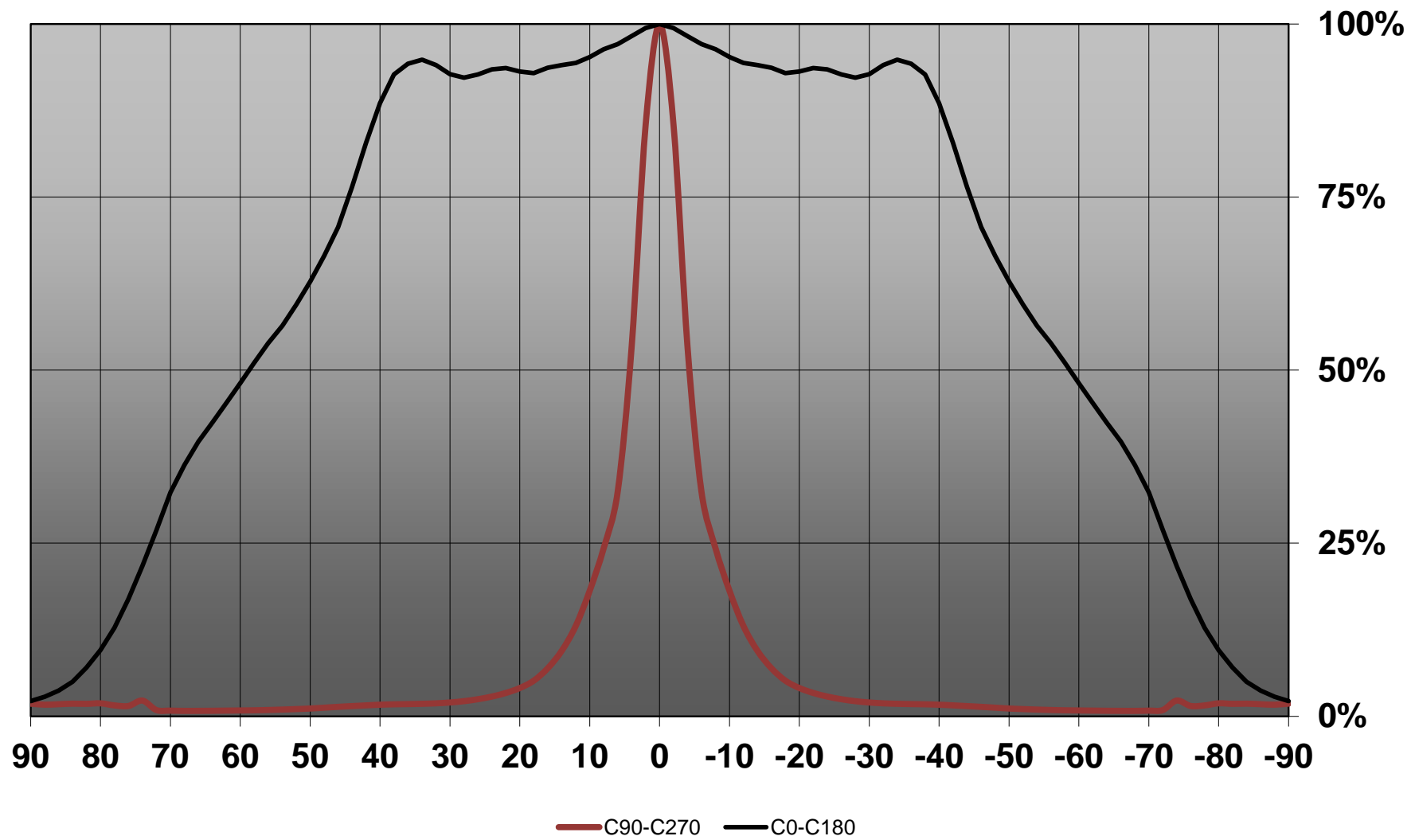

Relative intensity of CA10932_FLARE-B (Oslon Square EC)

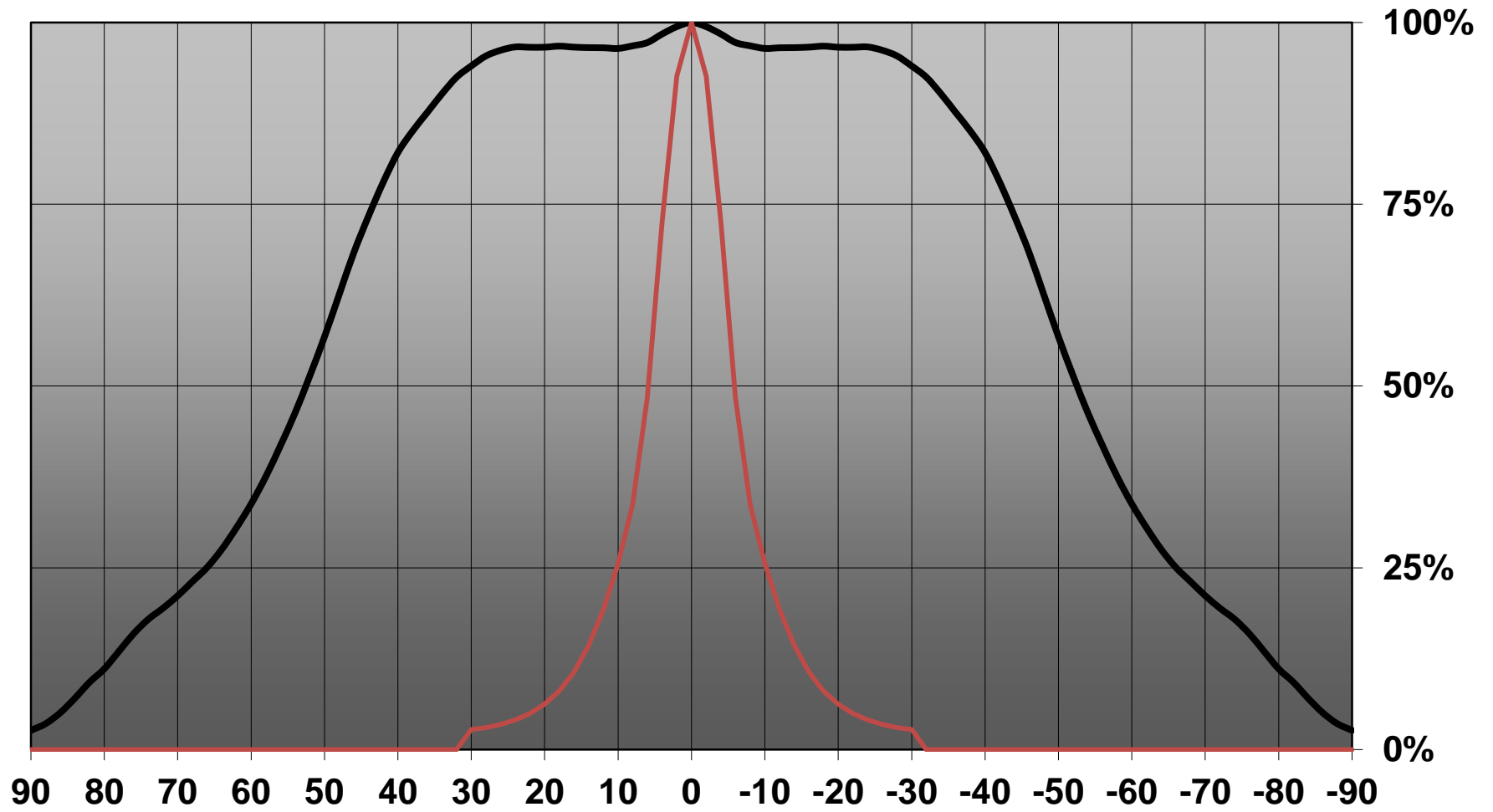

D

C

B

A

4

4

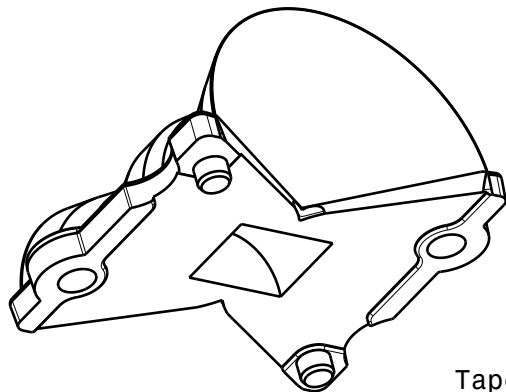

Isometric view
2:1

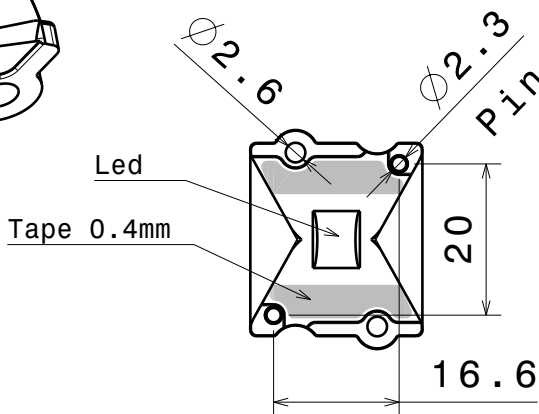

Bottom view

3

3

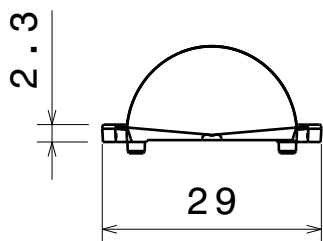

Right view

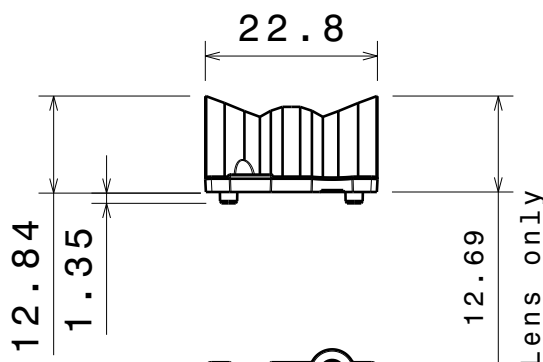

Front view

Part no.s:
CA10932_Flare-B

Part no. without tape fastening:
C10946_Flare-B

MATERIALS
Lens: PMMA
Tape: PU Foam

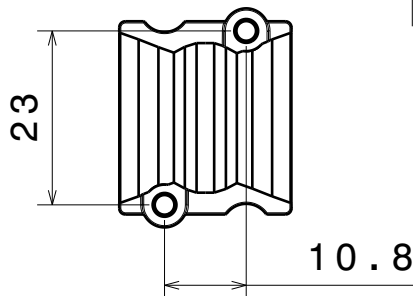

Top view

2

2

Tolerances if not otherwise shown
According to DIN ISO 2768-1
Linear measures:
Up to 30mm class M, otherwise class C.
According to DIN ISO 2768-2
Form and position: class L

LEDiL

Ledil Oy
Salorankatu 10
FIN 24240 SALO
Finland

THIRD ANGLE PROJECTION:

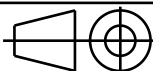

DRAWING TITLE

FLARE-B series

This drawing is the property
of LEDiL Oy. It may not be
reproduced, copied or
communicated without a written
agreement with LEDiL Oy.

SIZE PART NUMBER

A4

-

SCALE 1:1 WEIGHT

-

SHEET 1/1

D

A

1

1

Ledil Oy CA10932_Flare-B-XP-tape CA10932_Flare-B-XP-tape / LDC (Linear)

Luminaire: Ledil Oy CA10932_Flare-B-XP-tape CA10932_Flare-B-XP-tape
Lamps: 1 x Cree XP-E (White)

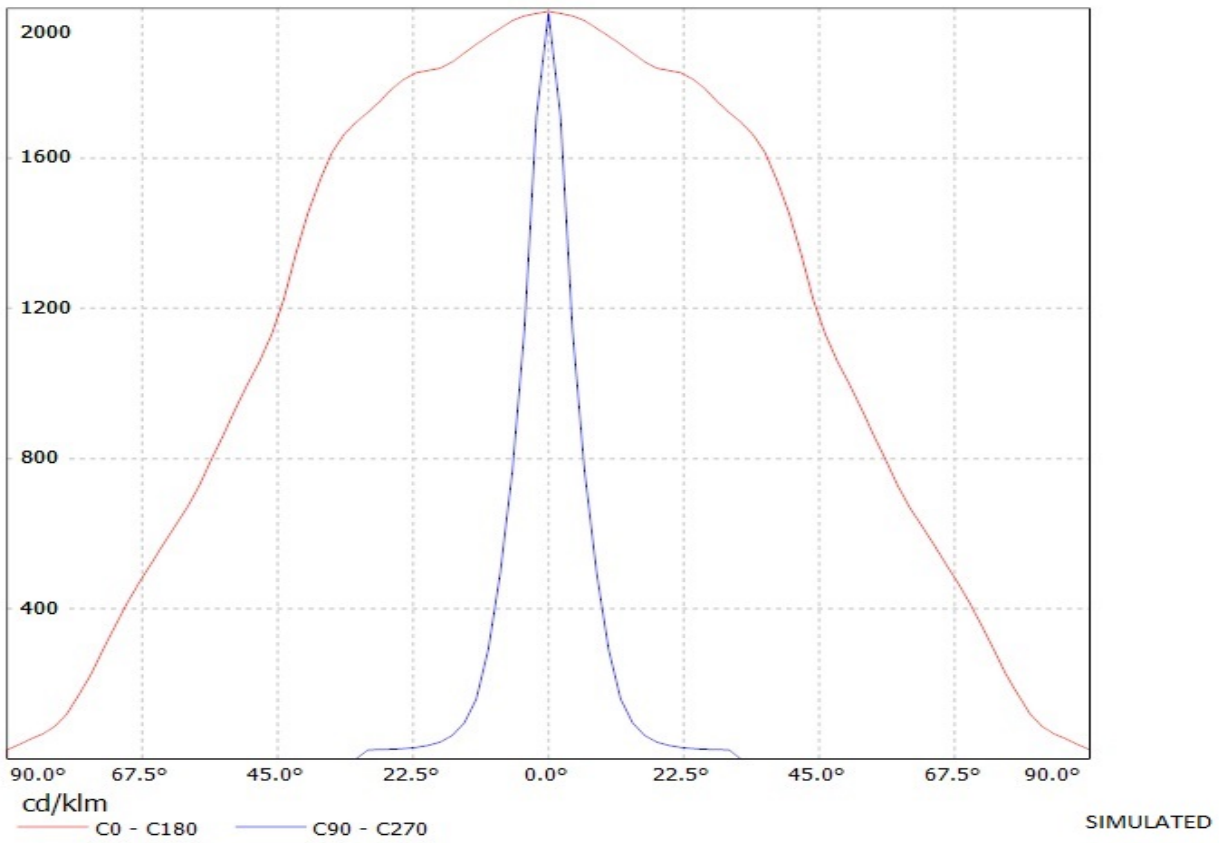

Ledil Oy CA10932_Flare-B-XP-G-tape CA10932_Flare-B-XP-G-tape / LDC (Linear)

Luminaire: Ledil Oy CA10932_Flare-B-XP-G-tape CA10932_Flare-B-XP-G-tape
Lamps: 1 x Cree XP-G (White)

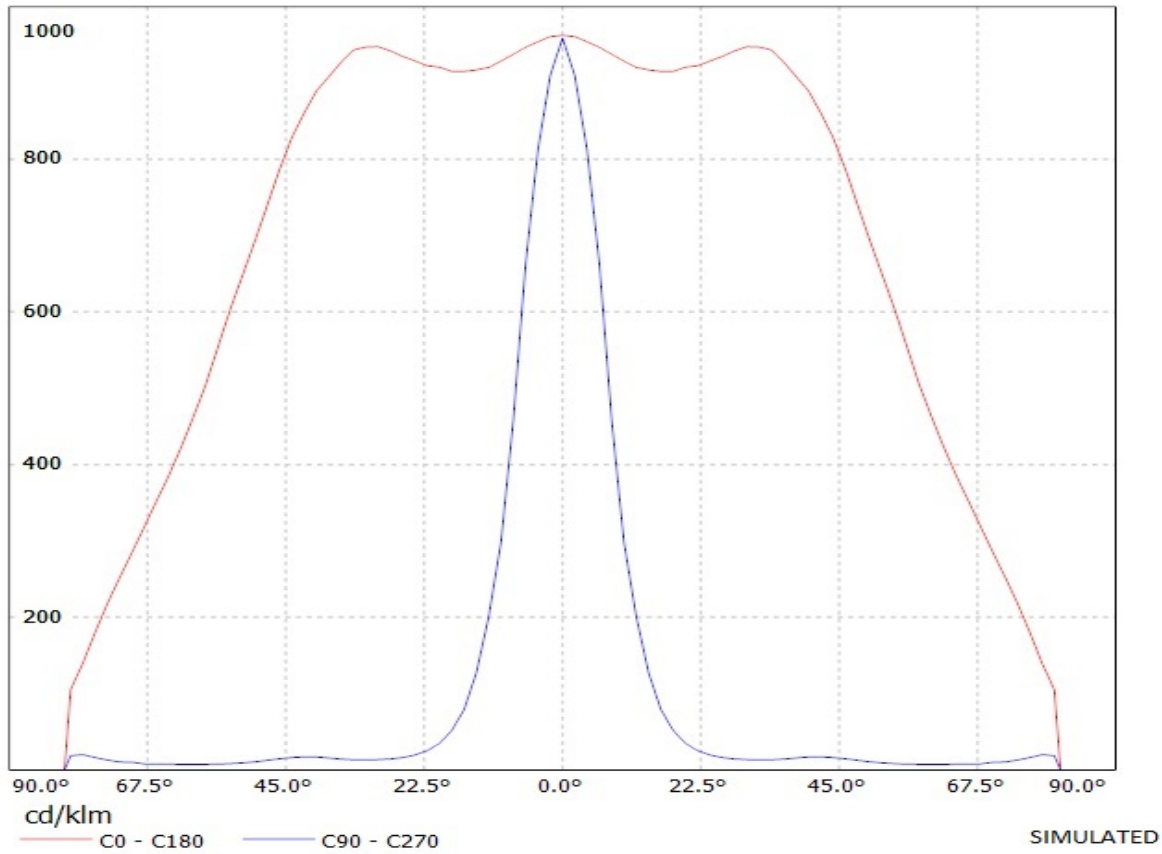

Luminaire: LEDIL OY CA10932_FLARE-B (XB-D) Efficiency=93%
Lamps: 1 x Cree XB-D white (97lm @ 250mA)

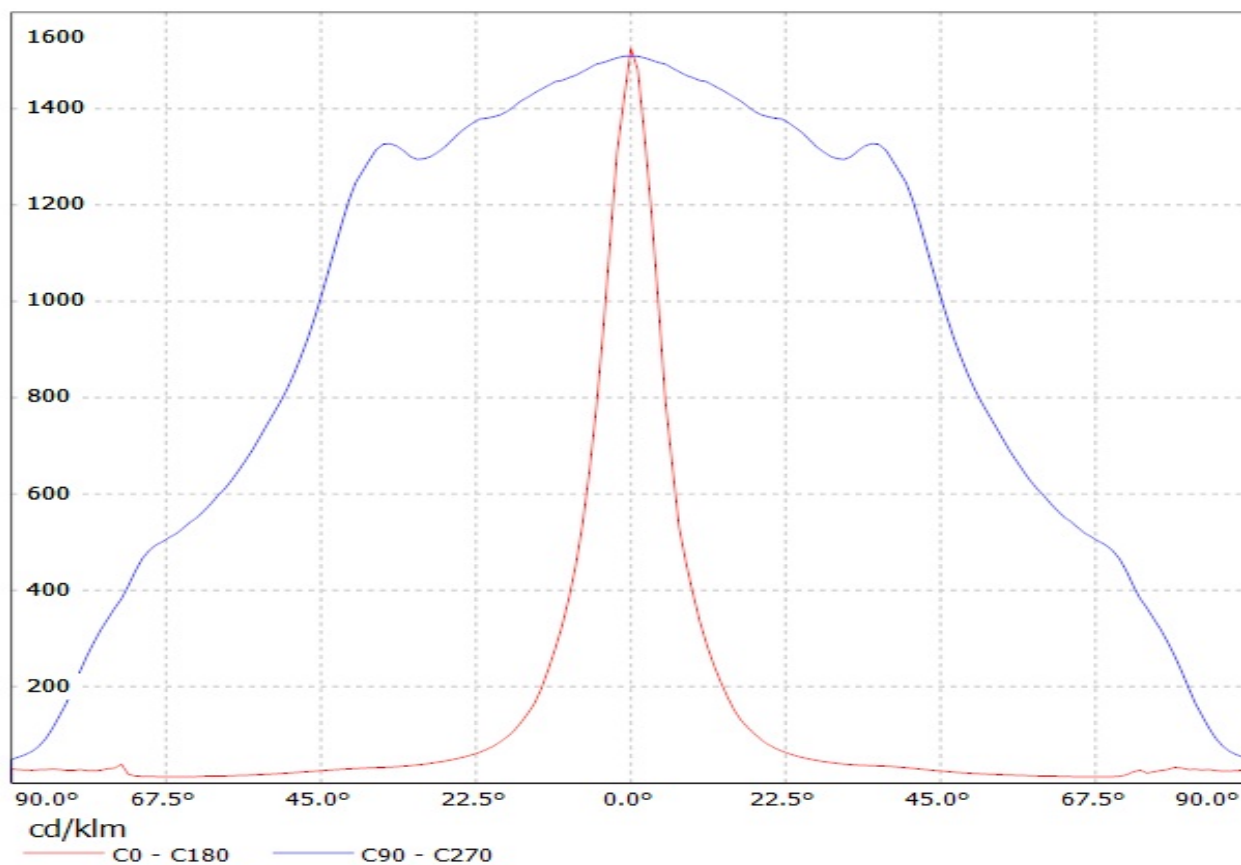

Luminaire: Ledil Oy CA10932_FLARE-B_(XP-E2) Efficiency=94%
Lamps: 1 x Cree XP-E2 (92lm @ 250mA) CCT=5500K P=0.8W I=250mA

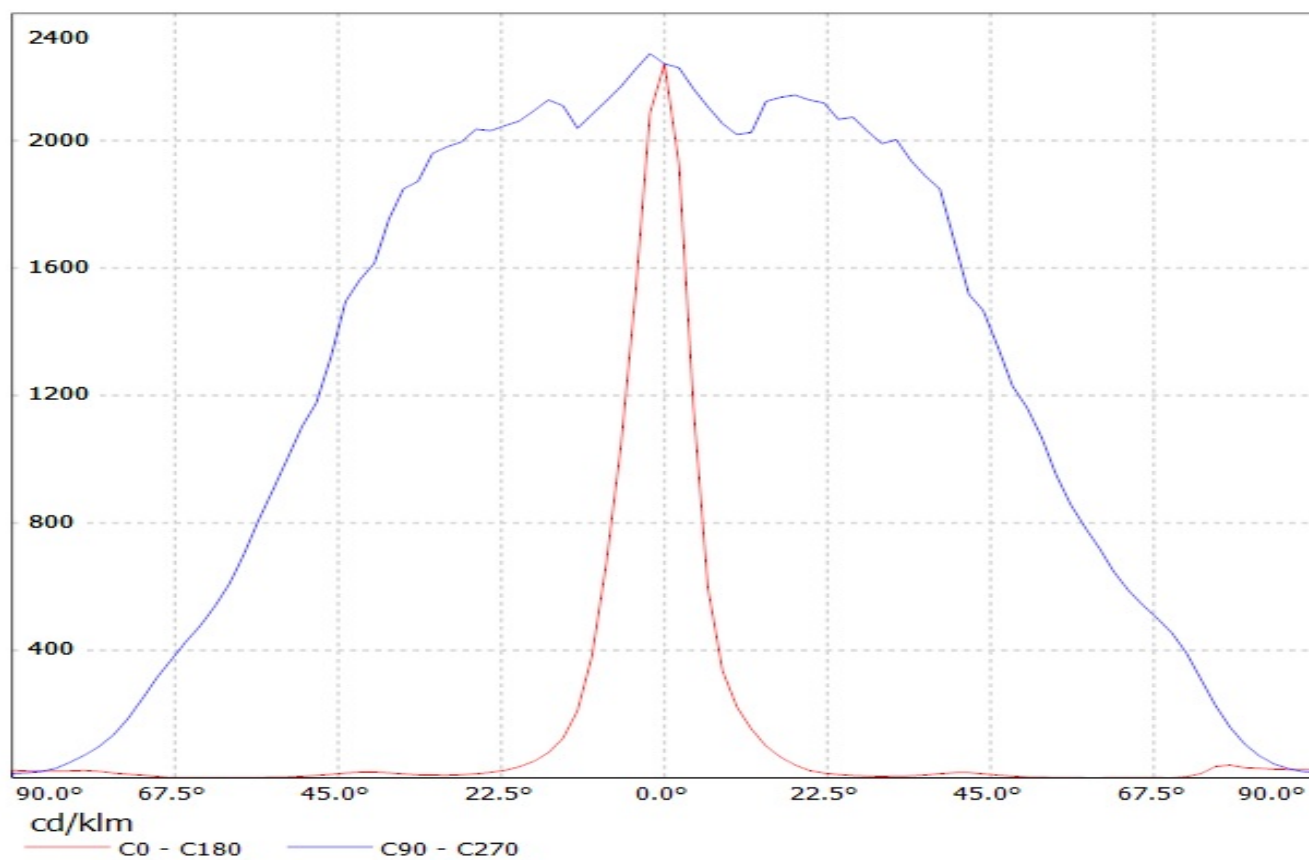

Ledil Oy CA10932_Flare-B-RE-tape CA10932_Flare-B-RE-tape / LDC (Linear)

Luminaire: Ledil Oy CA10932_Flare-B-RE-tape CA10932_Flare-B-RE-tape
Lamps: 1 x Luxeon Rebel (white/neut)

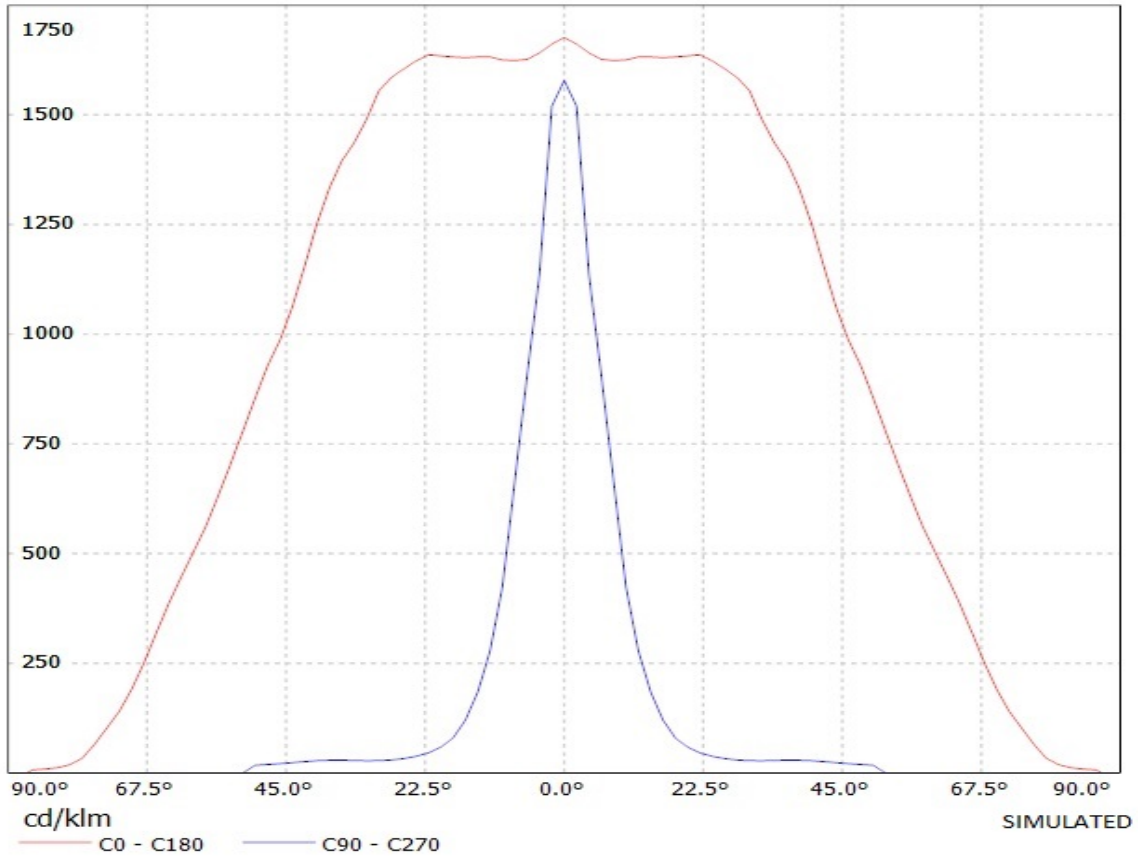

Ledil Oy C10922_GT4-OSL-M C10922_GT4-OSL-M SSL80 333lm @ 250mA LOR=87% / LDC
(Linear)

Luminaire: Ledil Oy C10922_GT4-OSL-M C10922_GT4-OSL-M SSL80 333lm @ 250mA LOR=87%
Lamps: 1 x Osram Oslon SSL80

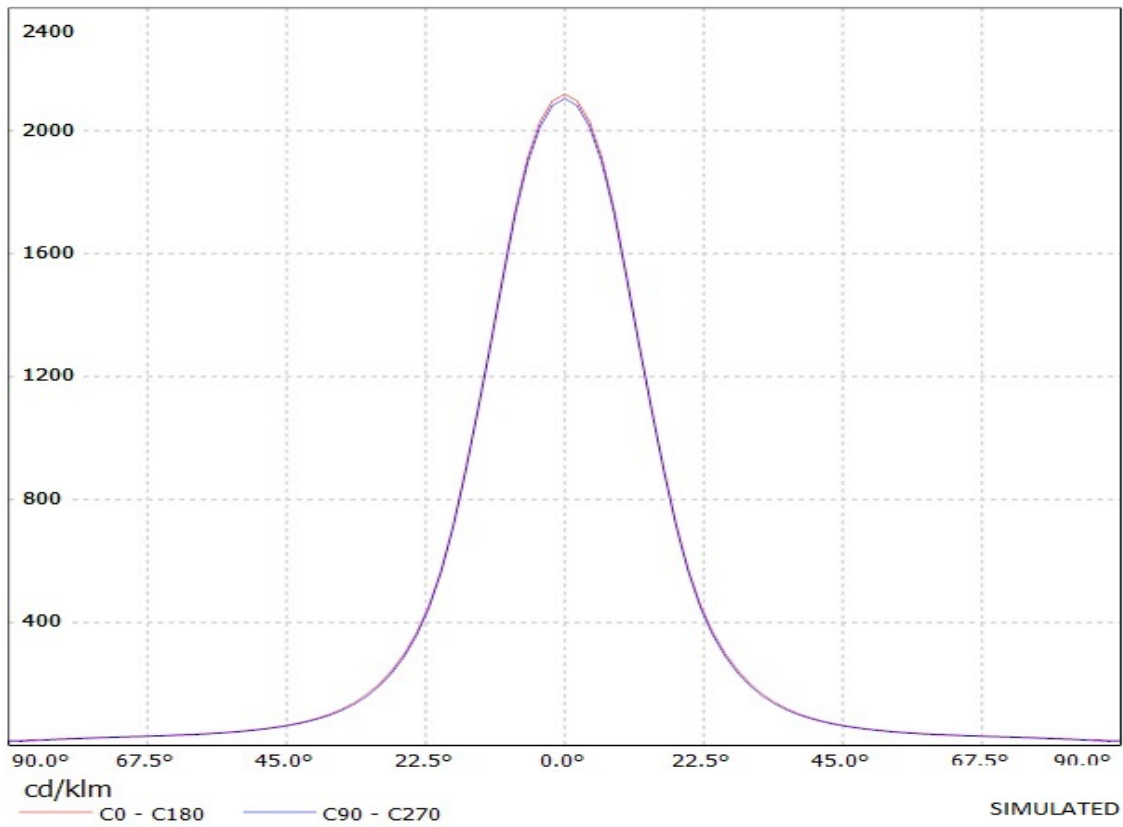

LEDiL Oy CA10932_FLARE-B_(LUXEON_T)_2 Eff.92.7% / LDC (Linear)

Luminaire: LEDiL Oy CA10932_FLARE-B_(LUXEON_T)_2 Eff.92.7%
Lamps: 1 x LUXEON T (74lm@250mA)

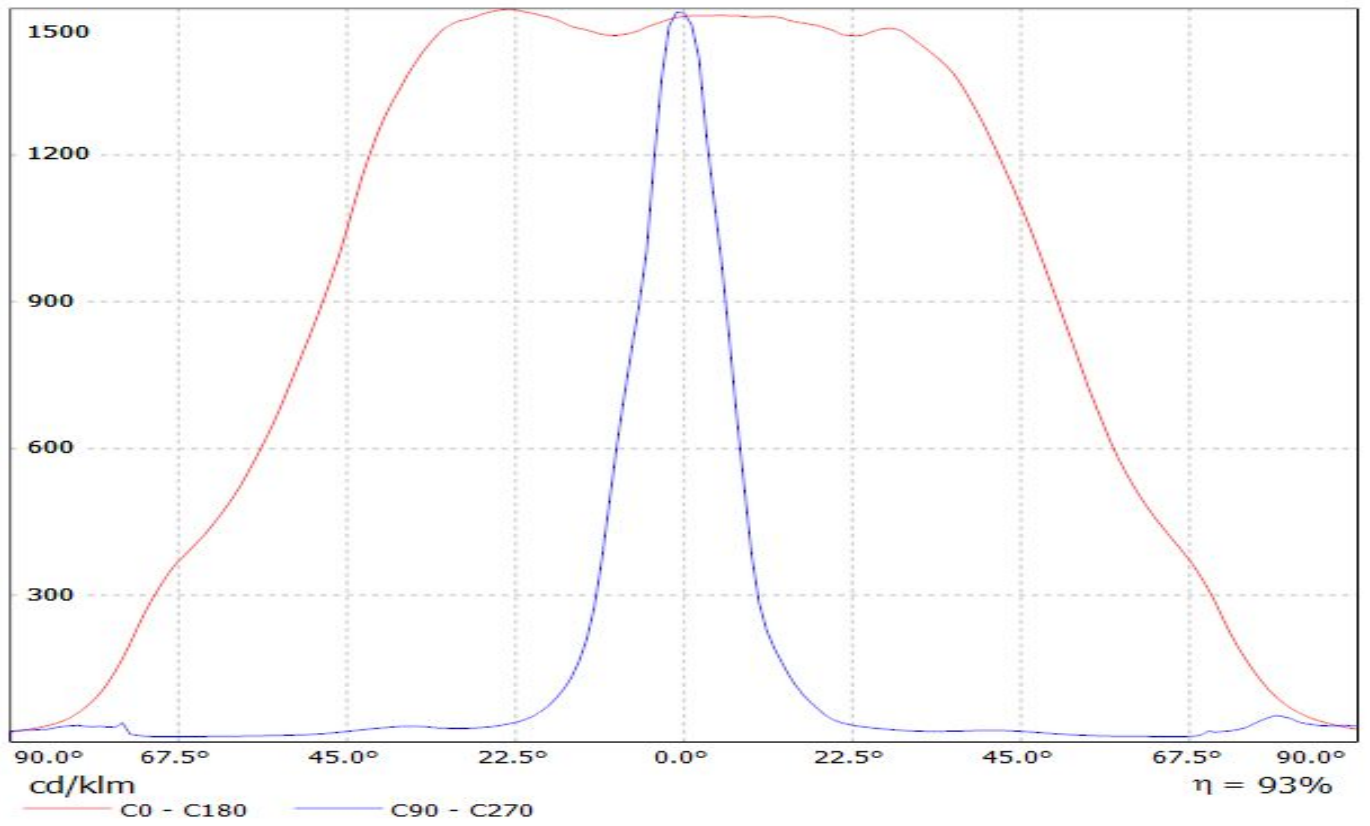

Luminaire: LEDil Oy CA10932_FLARE-B_(Luxeon_TX)
Lamps: 1 x Luxeon TX (96lm @ 250mA) $\bar{P}=0.7W$ $I=250mA$

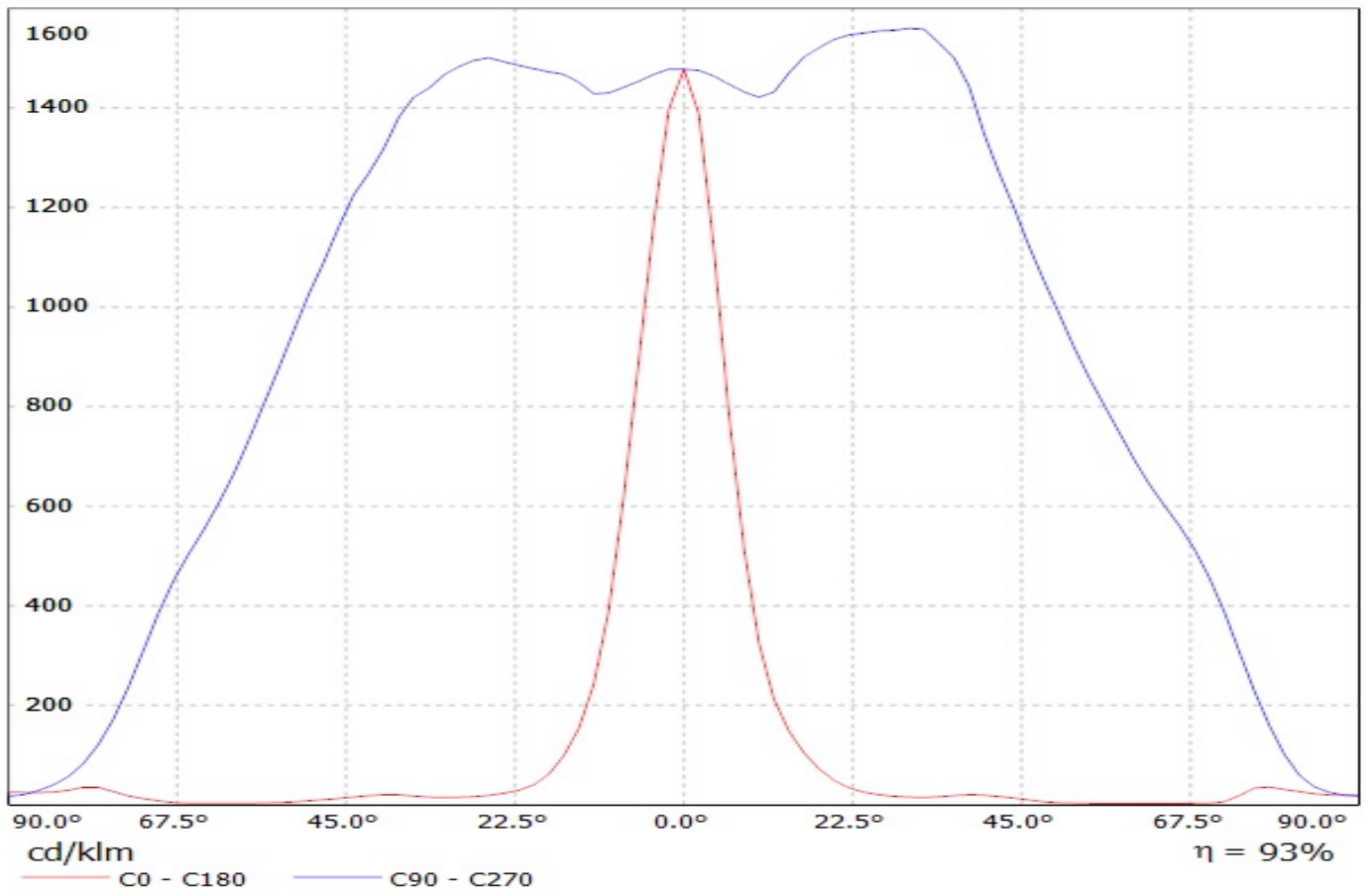

Luminaire: LEDiL Oy CA10932_FLARE-B_(NVSL219CE)
Lamps: 1 x Nichia_NVSL219CE_101.227lm@250mA_P=0.713404W_I=0.25A

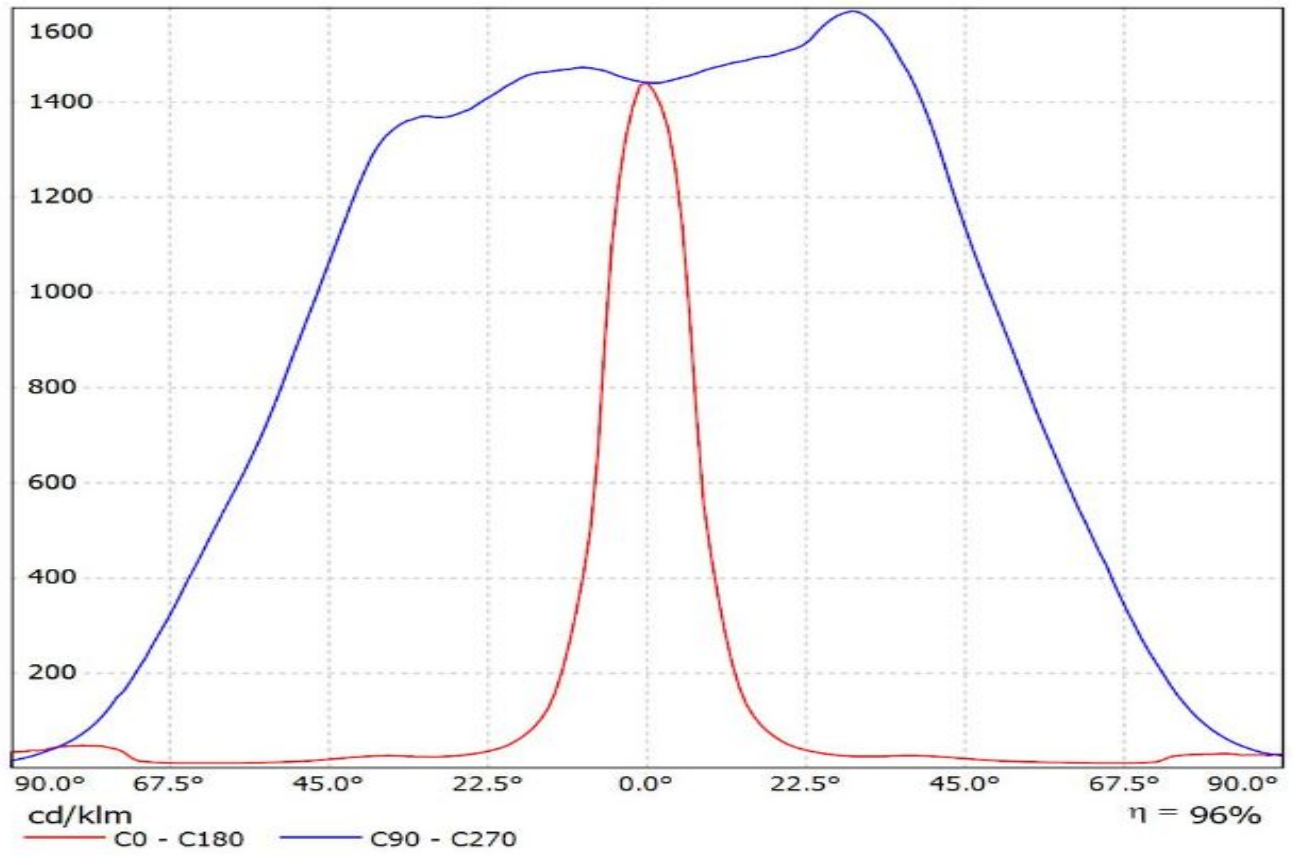

Luminaire: LEDiL Oy FLARE-B (SSL150)

Lamps: 1 x Osram_Oslon_SSL150_(LCW CRUP.EC-KTLP-607Q-1)_84lm@250mA_P=0.745802W_I=249.9mA

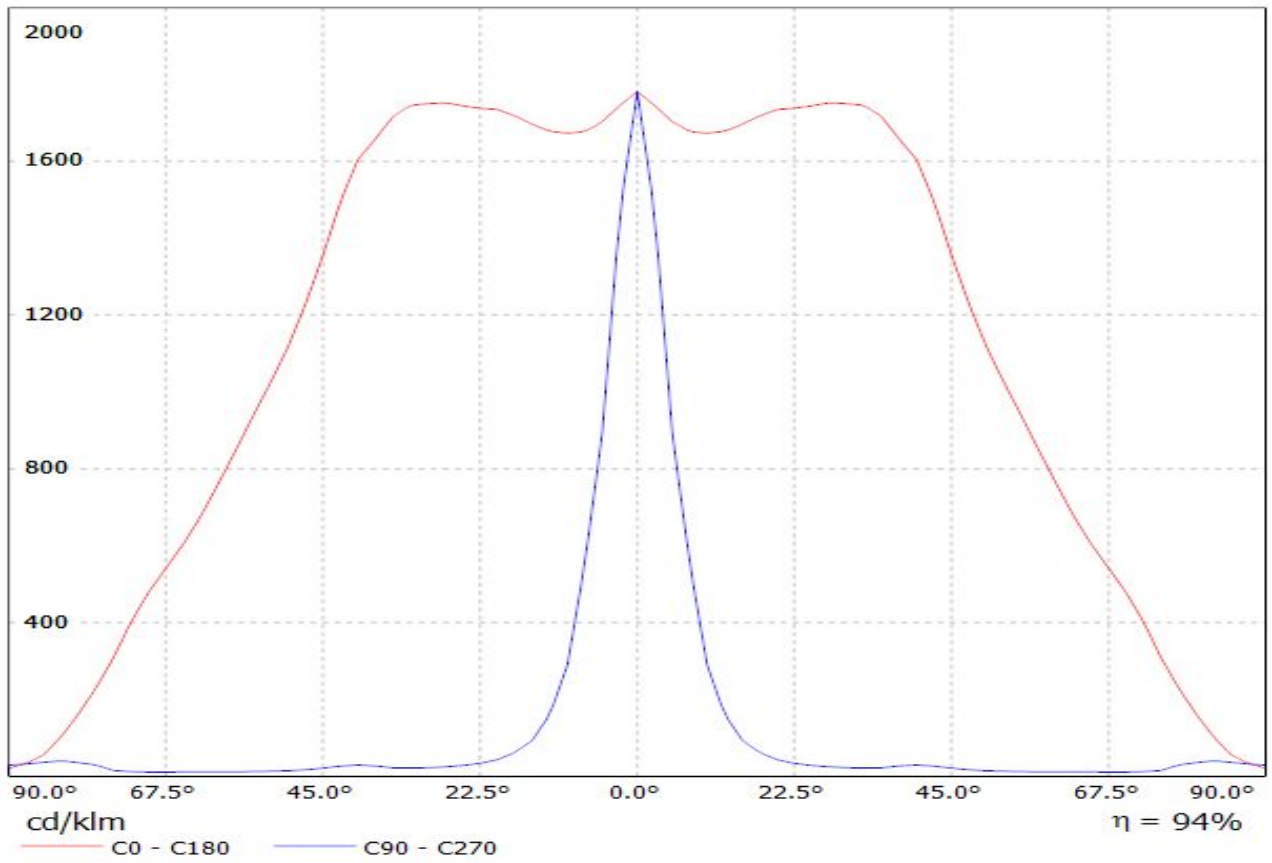

Ledil Oy CA10932_Flare-B-XP-tape CA10932_Flare-B-XP-tape / LDC (Polar)

Luminaire: Ledil Oy CA10932_Flare-B-XP-tape CA10932_Flare-B-XP-tape

Lamps: 1 x Cree XP-E (White)

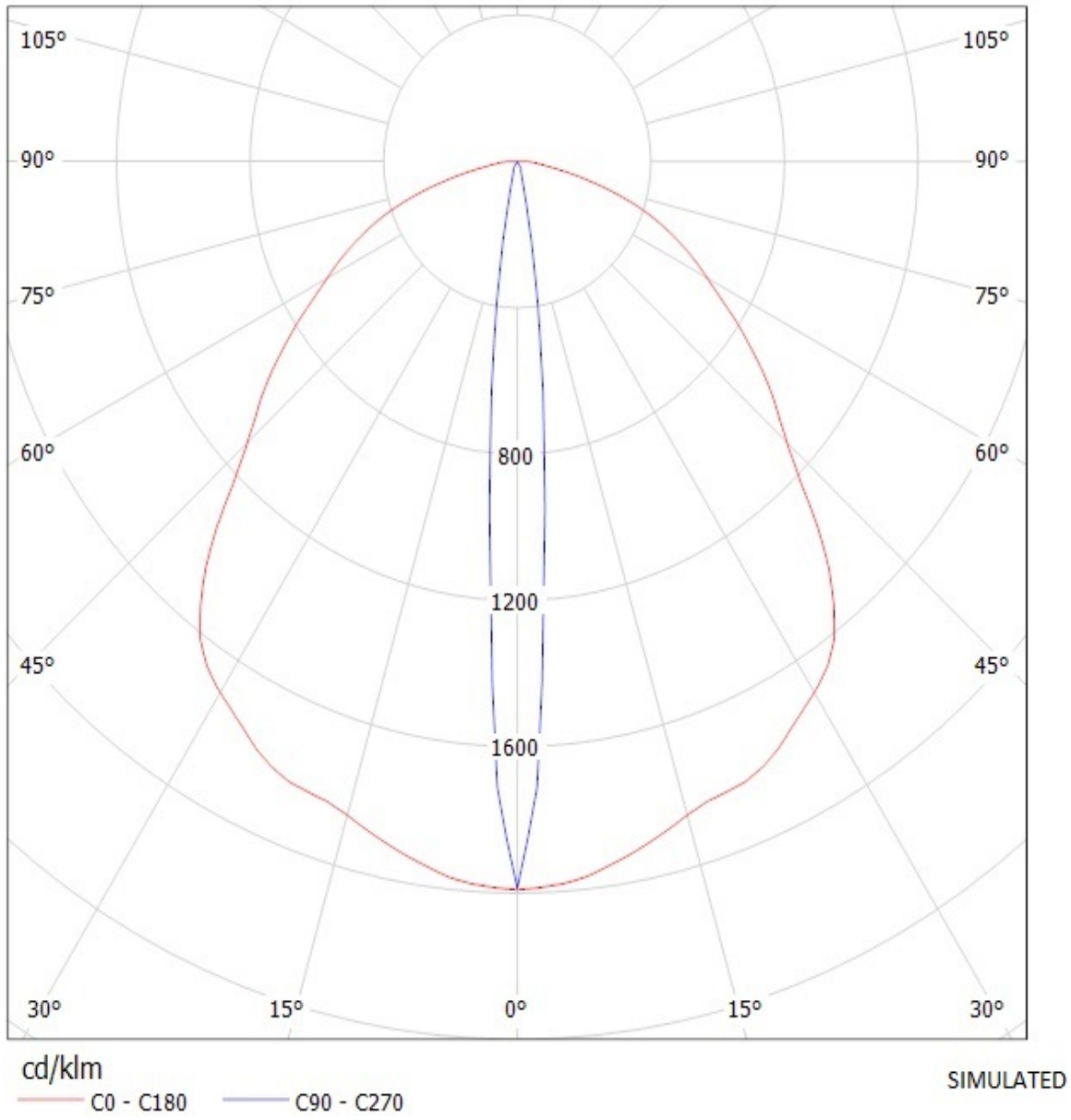

Ledil Oy CA10932_Flare-B-XP-G-tape CA10932_Flare-B-XP-G-tape / LDC (Polar)

Luminaire: Ledil Oy CA10932_Flare-B-XP-G-tape CA10932_Flare-B-XP-G-tape
Lamps: 1 x Cree XP-G (White)

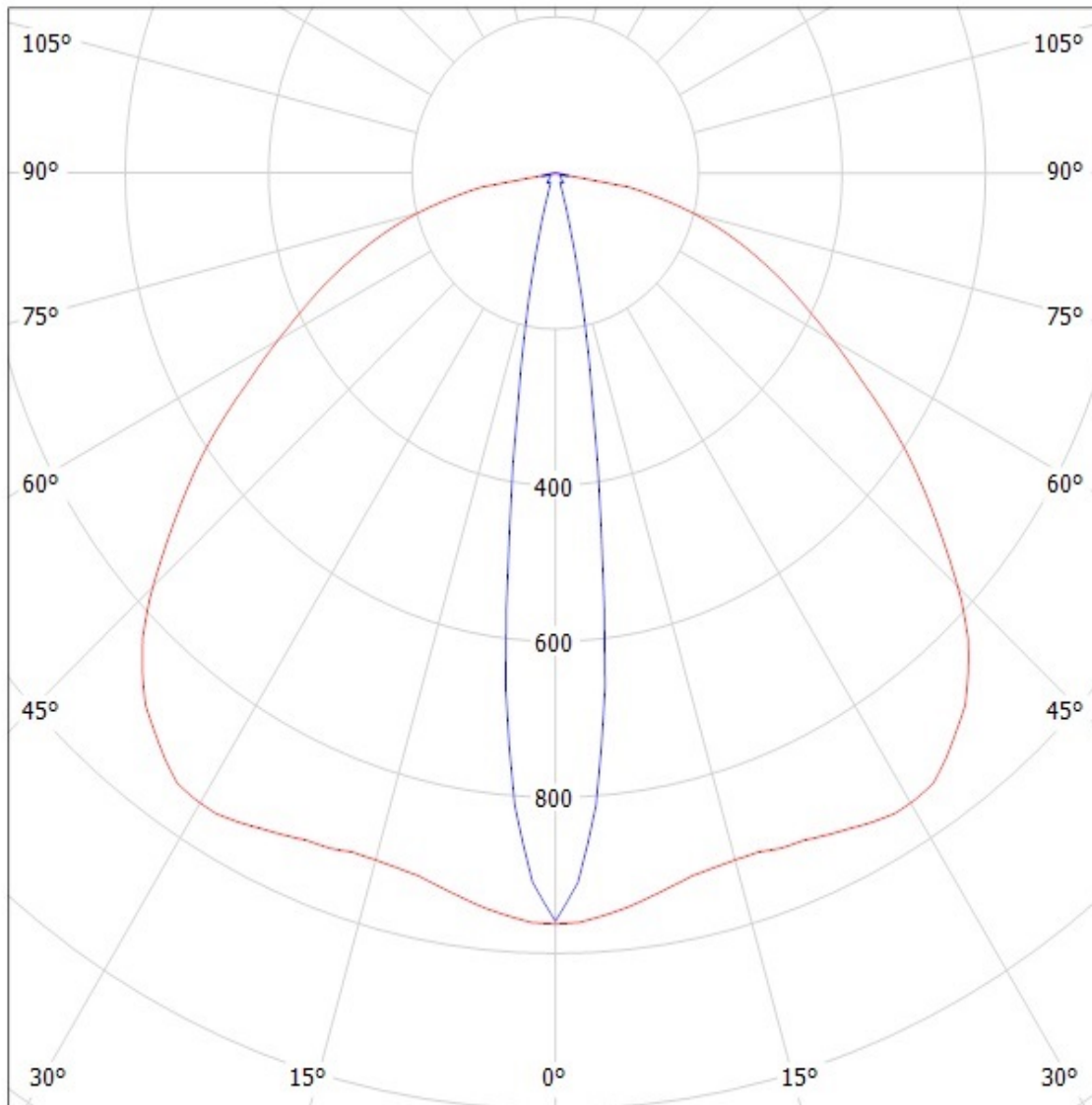

cd/klm

— C0 - C180 — C90 - C270

SIMULATED

Luminaire: LEDIL OY CA10932_FLARE-B (XB-D) Efficiency=93%
Lamps: 1 x Cree XB-D white (97lm @ 250mA)

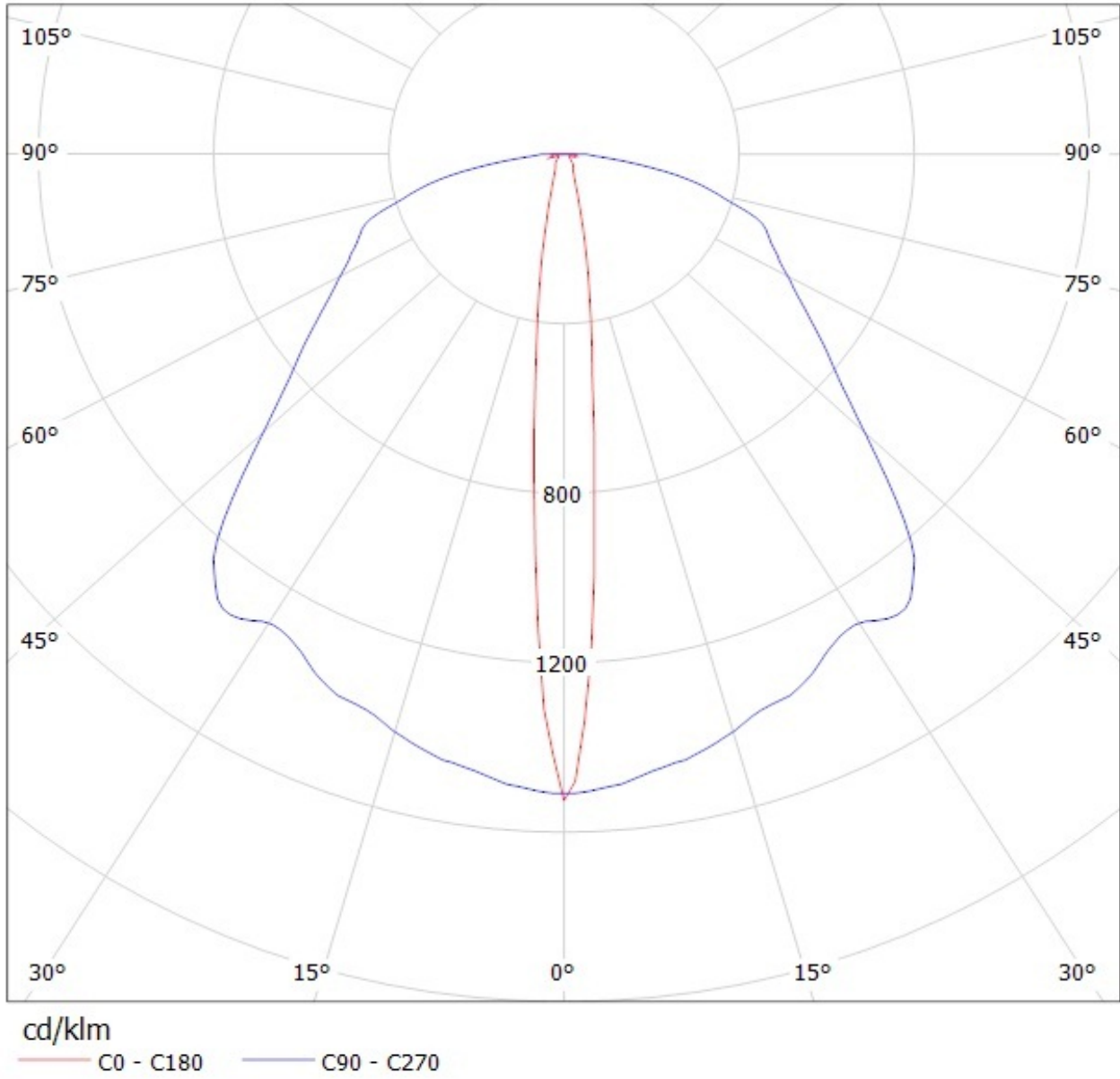

Luminaire: Ledil Oy CA10932_FLARE-B_(XP-E2) Efficiency=94%
Lamps: 1 x Cree XP-E2 (92lm @ 250mA) CCT=5500K P=0.8W I=250mA

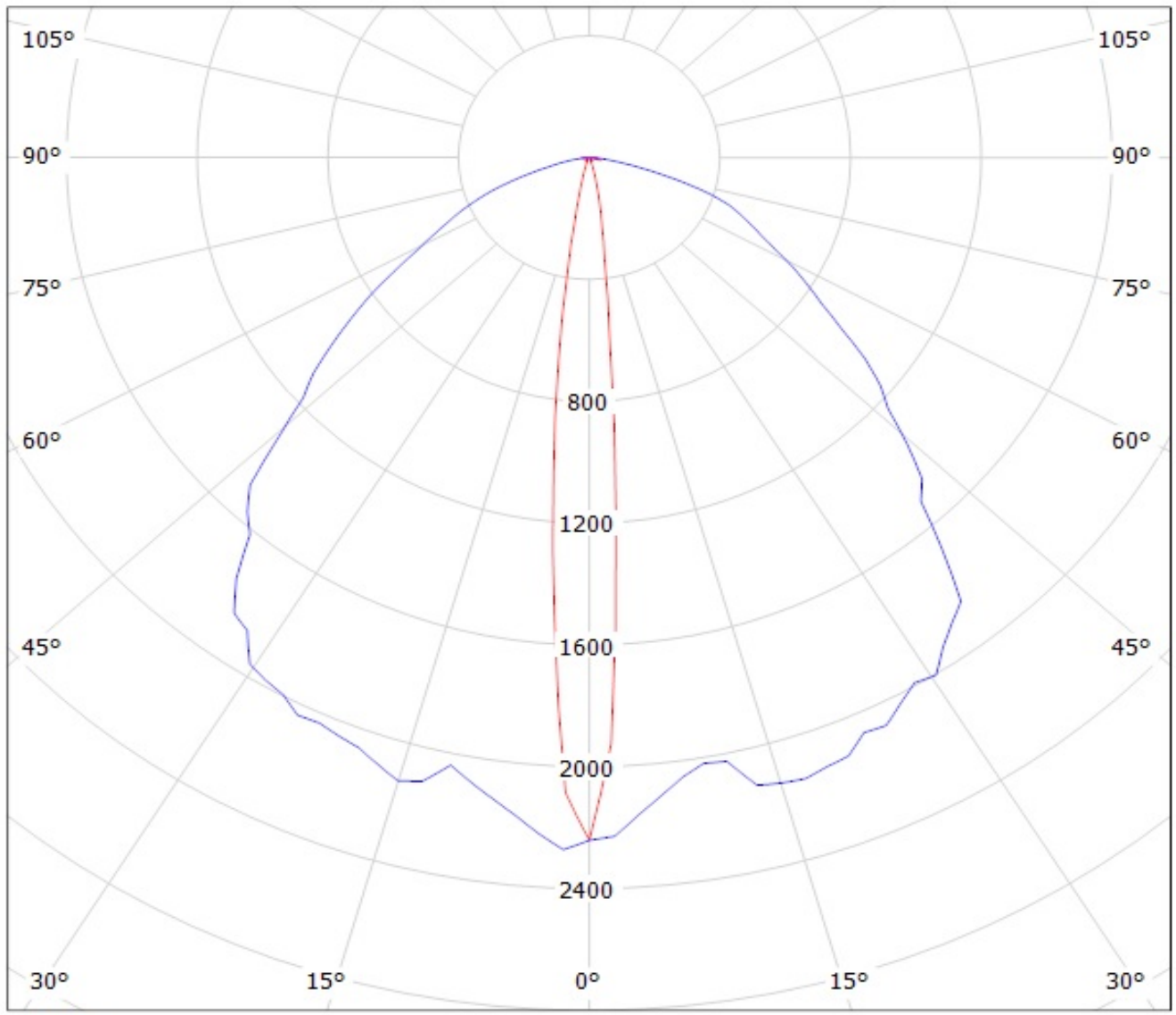

cd/klm
— C0 - C180 — C90 - C270

Ledil Oy CA10932_Flare-B-RE-tape CA10932_Flare-B-RE-tape / LDC (Polar)

Luminaire: Ledil Oy CA10932_Flare-B-RE-tape CA10932_Flare-B-RE-tape
Lamps: 1 x Luxeon Rebel (white/neut)

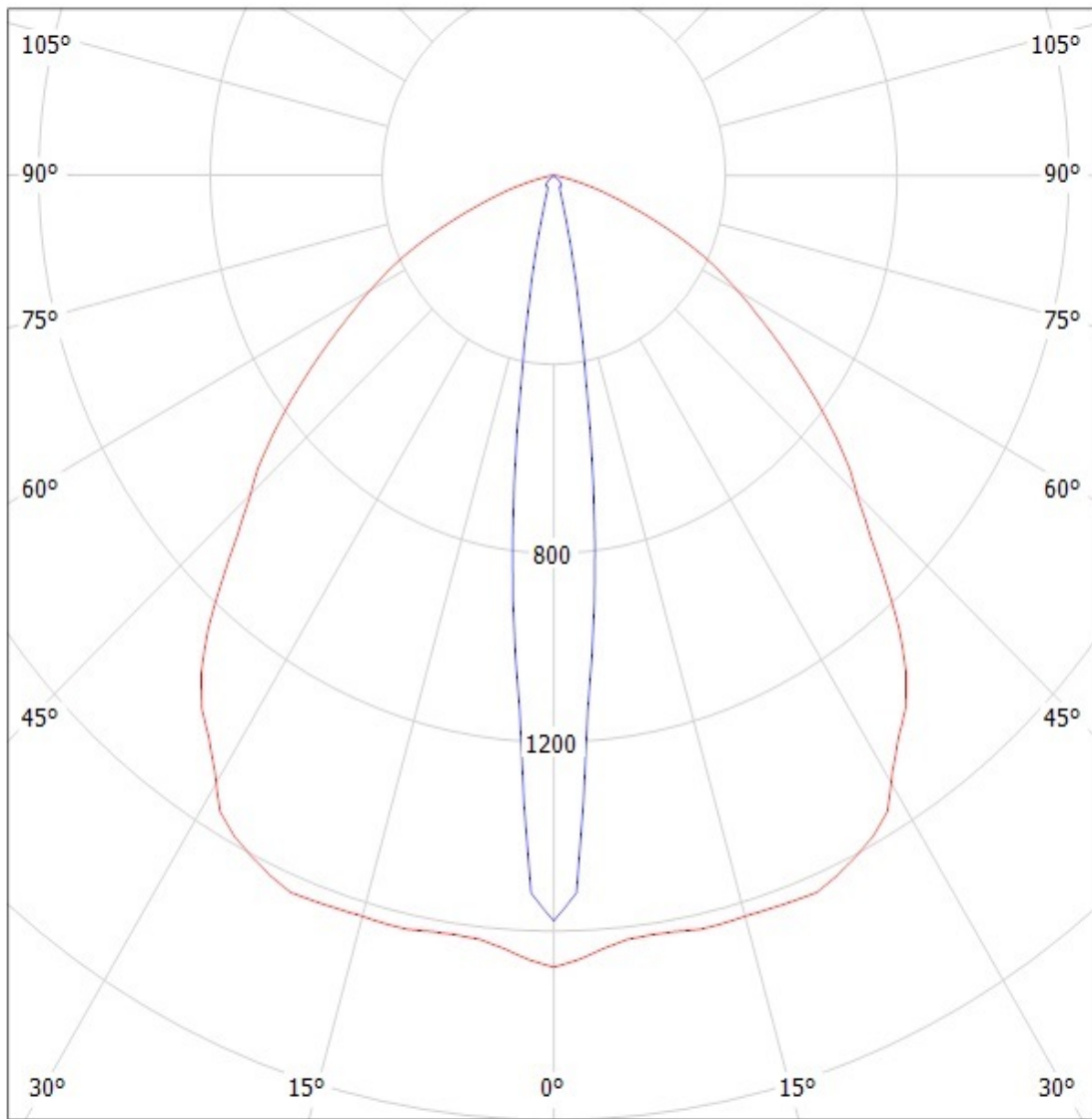

cd/klm

— C0 - C180 — C90 - C270

SIMULATED

Ledil Oy C10922_GT4-OSL-M C10922_GT4-OSL-M SSL80 333lm @ 250mA LOR=87% / LDC
(Polar)

Luminaire: Ledil Oy C10922_GT4-OSL-M C10922_GT4-OSL-M SSL80 333lm @ 250mA LOR=87%
Lamps: 1 x Osram Oslon SSL80

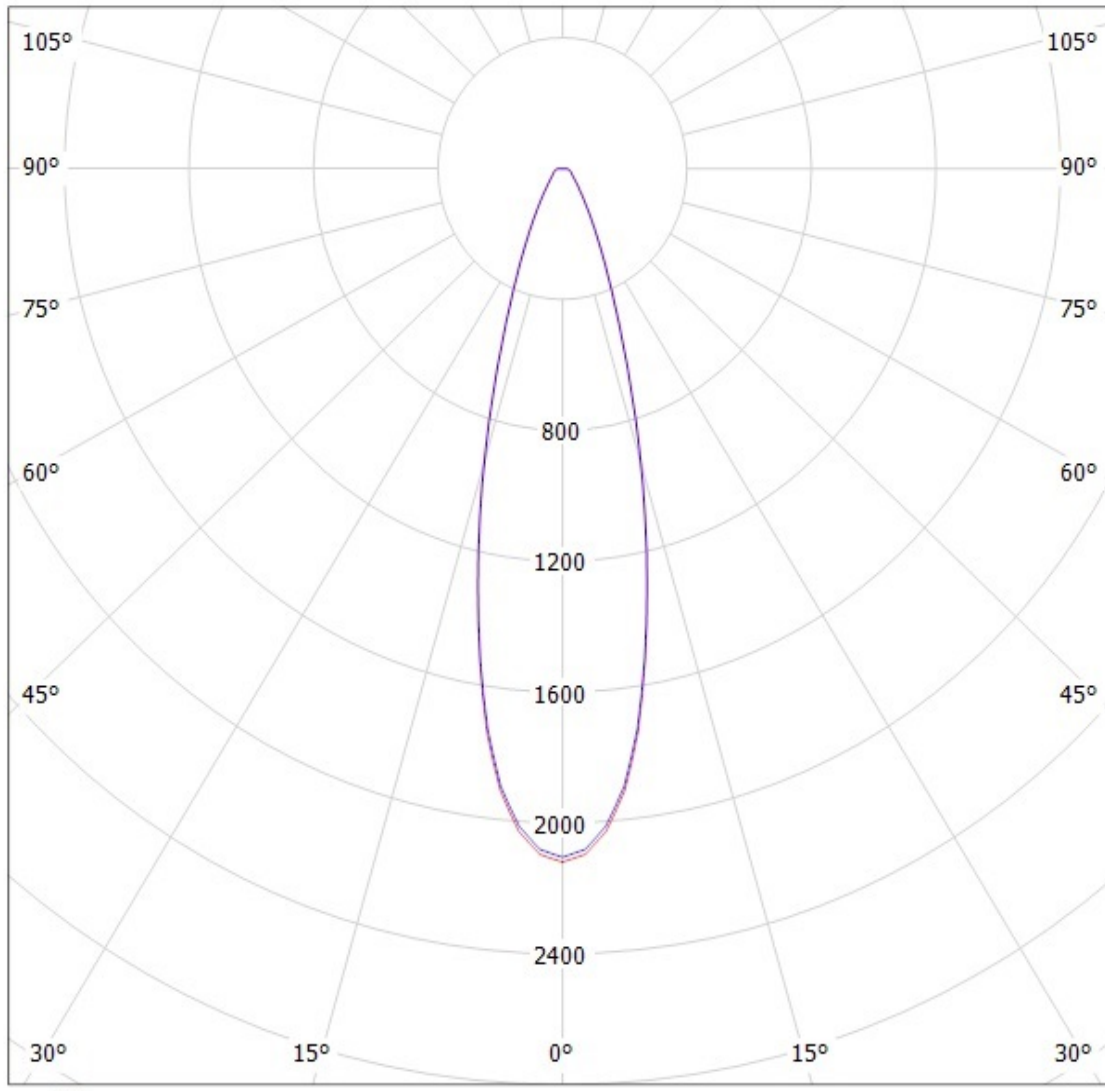

cd/klm

— C0 - C180 — C90 - C270

SIMULATED

LEDiL Oy CA10932_FLARE-B_(LUXEON_T)_2 Eff.92.7% / LDC (Polar)

Luminaire: LEDiL Oy CA10932_FLARE-B_(LUXEON_T)_2 Eff.92.7%

Lamps: 1 x LUXEON T (74lm@250mA)

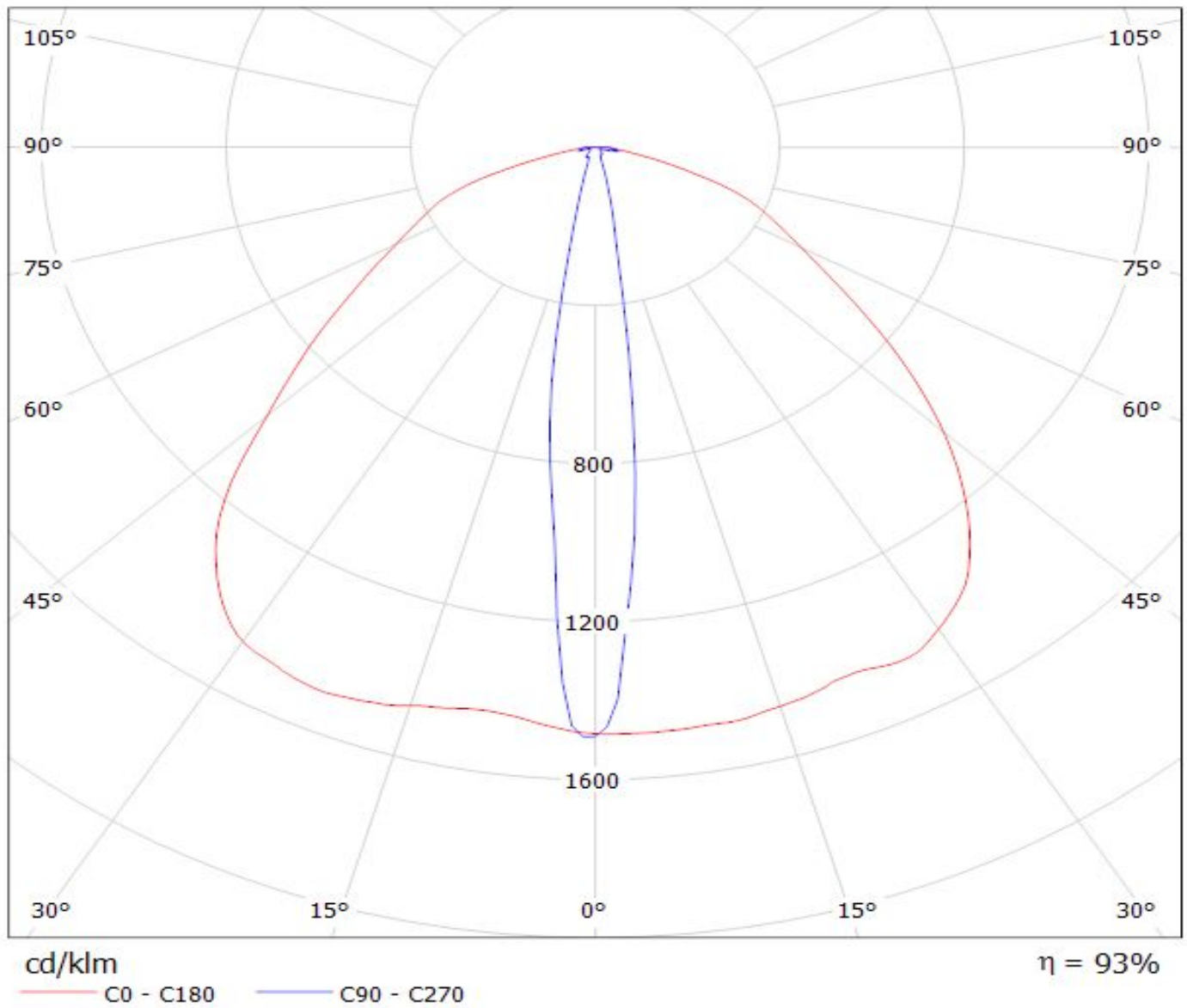

Luminaire: LEDil Oy CA10932_FLARE-B_(Luxeon_TX)
Lamps: 1 x Luxeon TX (96lm @ 250mA) P=0.7W I=250mA

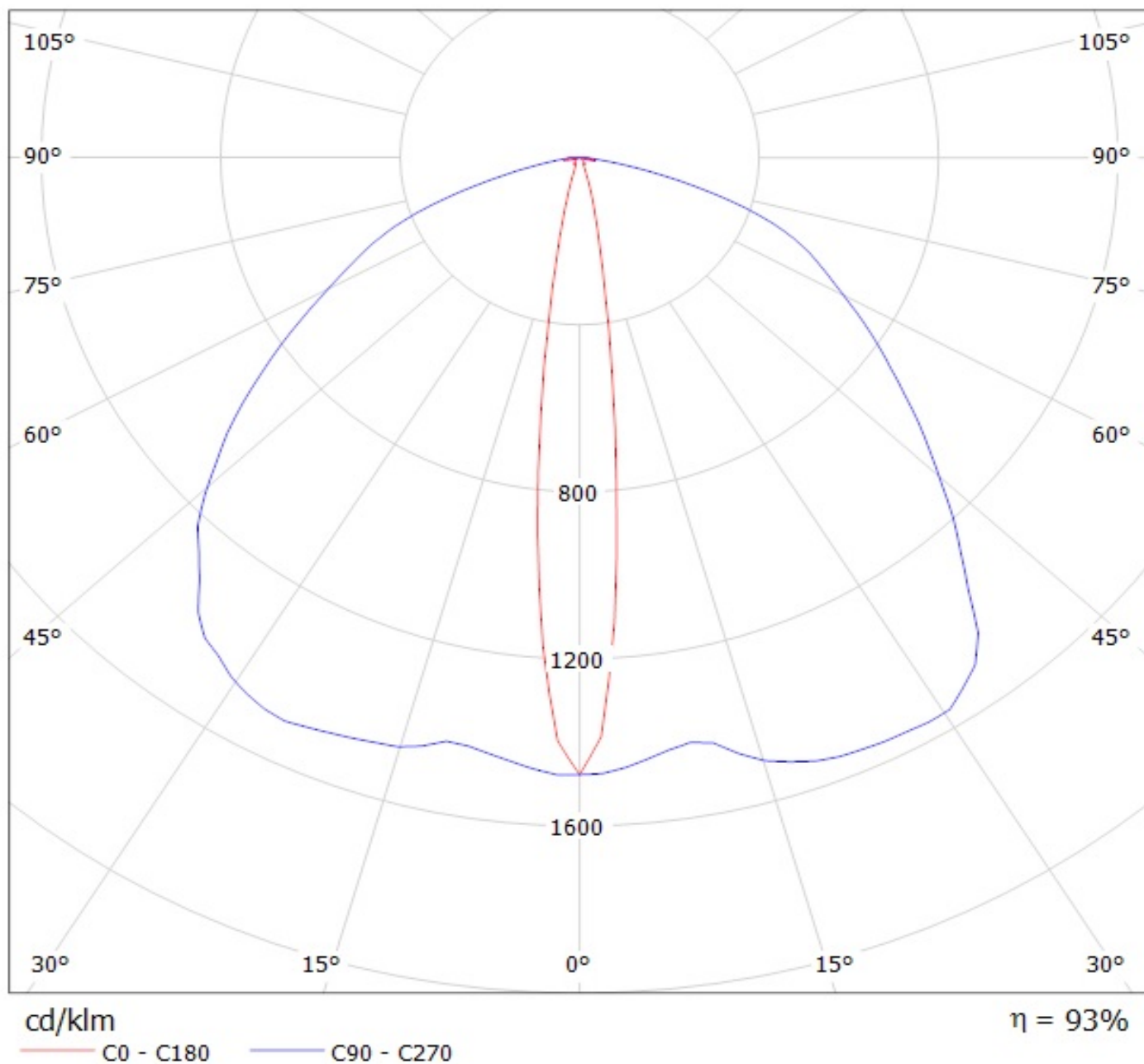

Luminaire: LEDiL Oy CA10932_FLARE-B_(NVSL219CE)

Lamps: 1 x Nichia_NVSL219CE_101.227lm@250mA_P=0.713404W_I=0.25A

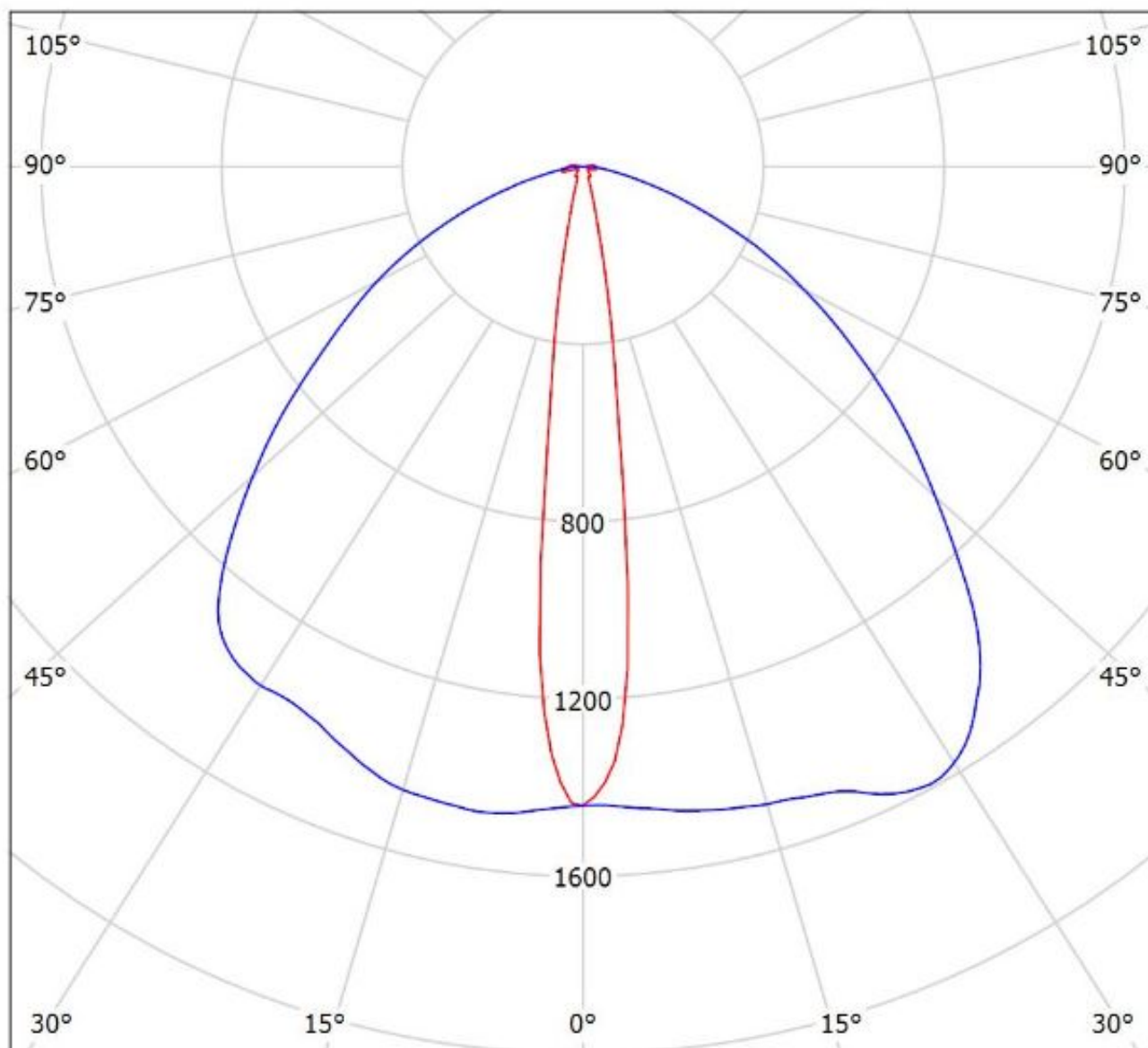

cd/klm

— C0 - C180 — C90 - C270

$\eta = 96\%$

Luminaire: LEDiL Oy FLARE-B_(SSL150)

Lamps: 1 x Osram_Oslon_SSL150_(LCW CRUP.EC-KTLP-607Q-1)_84lm@250mA_P=0.745802W_I=249.9mA

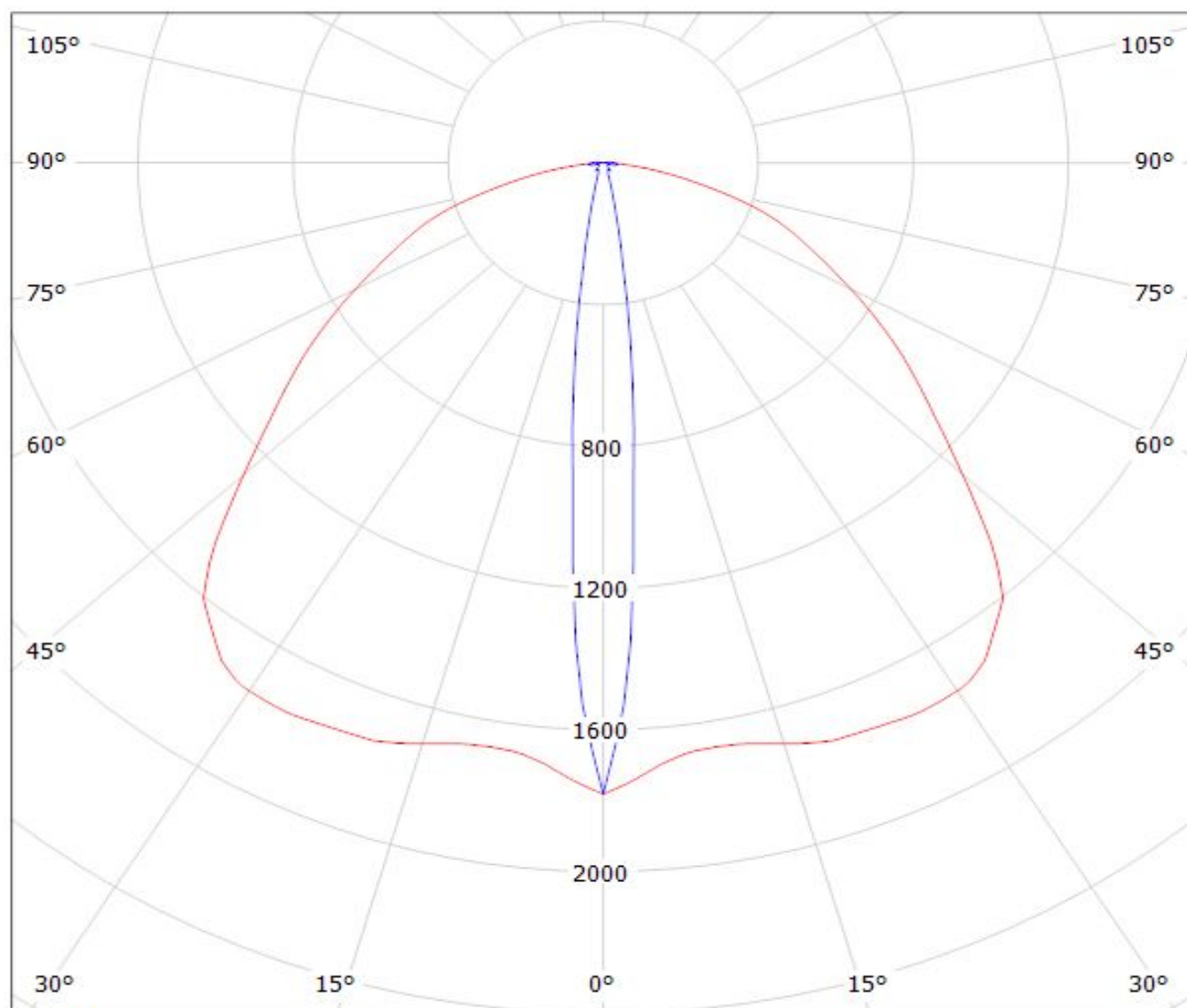

cd/klm

— C0 - C180

— C90 - C270

$\eta = 94\%$

NOTE: The typical divergence will be changed by different color, chip size and chip position tolerance. The typical total divergence is the full angle measured where the luminous intensity is half of the peak value.