

10W isolated DC-DC converter DIP package
Wide input and regulated dual/ single output

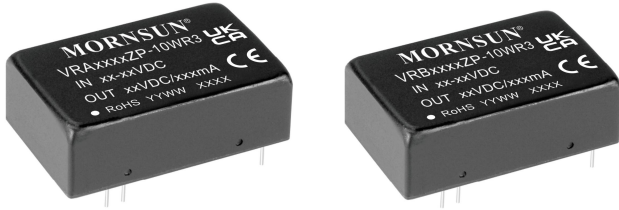

Patent Protection
CE Report EN62368-1
UK CA Report BS EN62368-1
RoHS

FEATURES

- Wide 2:1 input voltage range
- High efficiency up to 88%
- No-load power consumption as low as 0.11W
- I/O isolation test voltage 1.5k VDC
- Operating ambient temperature range: -40°C to +85°C
- Input under-voltage protection, output short-circuit, over-current, over-voltage protection
- Meet CISPR32/EN55032 CLASS A without extra components
- Industry standard pin-out

VRA_ZP-10WR3 & VRB_ZP-10WR3 series are isolated 10W DC-DC converter products with a wide range of voltage input of 9-18VDC, 18-36VDC, 36-75VDC, isolation voltage of 1500VDC, input under-voltage protection, output short-circuit, over-current, over-voltage protection and EMI meets CISPR32/EN55032 CLASS A without external components; these products are widely used in fields such as industrial control, electric power, instruments and communication.

Selection Guide

Certification	Part No.	Input Voltage (VDC)		Output		Full Load Efficiency ^② (%)Min./Typ.	Capacitive Load ^③ (μF)Max.
		Nominal (Range)	Max. ^①	Voltage(VDC)	Current (mA) Max./Min.		
EN/BS EN	VRA1205ZP-10WR3	12 (9-18)	20	±5	±1000/0	81/83	1000
	VRA1212ZP-10WR3			±12	±416/0	84/86	470
	VRA1215ZP-10WR3			±15	±333/0	84/86	330
	VRB1203ZP-10WR3			3.3	2400/0	84/86	1200
	VRB1205ZP-10WR3			5	2000/0	84/86	1000
	VRB1212ZP-10WR3			12	833/0	85/87	470
	VRB1215ZP-10WR3			15	667/0	85/87	330
	VRB1224ZP-10WR3			24	416/0	86/88	100
	VRA2405ZP-10WR3	24 (18-36)	40	±5	±1000/0	81/83	1000
	VRA2412ZP-10WR3			±12	±416/0	85/87	470
	VRA2415ZP-10WR3			±15	±333/0	85/87	330
	VRB2403ZP-10WR3			3.3	2400/0	83/85	1200
	VRB2405ZP-10WR3			5	2000/0	85/87	1000
	VRB2412ZP-10WR3			12	833/0	84/86	470
	VRB2415ZP-10WR3			15	667/0	85/87	330
	VRB2424ZP-10WR3			24	416/0	84/86	100
	VRA4805ZP-10WR3	48 (36-75)	80	±5	±1000/0	81/83	1000
	VRA4812ZP-10WR3			±12	±416/0	85/87	470
	VRA4815ZP-10WR3			±15	±333/0	85/87	330
	VRB4803ZP-10WR3			3.3	2400/0	84/86	1200
	VRB4805ZP-10WR3			5	2000/0	85/87	1000
	VRB4812ZP-10WR3			12	833/0	85/87	470
	VRB4815ZP-10WR3			15	667/0	85/87	330
	VRB4824ZP-10WR3			24	416/0	86/88	100

Notes:

- ①Exceeding the maximum input voltage may cause permanent damage;
- ②Efficiency is measured at nominal input voltage and rated output load;
- ③The specified maximum capacitive load for positive and negative output is identical;
- ④We suggest to connect an external electrolytic capacitor if there is a spike voltage at the input, details please refer to application circuit.

Input Specifications

Item	Operating Conditions	Min.	Typ.	Max.	Unit	
Input Current (full load / no-load)	12VDC input, nominal input voltage	3.3VDC single output	--	759/15	777/30	mA
		5VDC single output	--	958/15	980/30	
		others	--	980/9	1028/15	
	24VDC input, nominal input voltage	3.3VDC single output	--	384/10	393/25	
		5VDC single output	--	474/5	485/12	
		others	--	490/5	515/12	
	48VDC input, nominal input voltage	3.3VDC single output	--	190/8	195/20	
		5VDC single output	--	237/5	243/12	
		others	--	245/4	258/8	
Reflected Ripple Current	12VDC nominal input series, nominal input voltage	--	50	--		
	24VDC nominal input series, nominal input voltage	--	40	--		
	48VDC nominal input series, nominal input voltage	--	30	--		
Surge Voltage (1sec. max.)	12VDC nominal input series	-0.7	--	25	VDC	
	24VDC nominal input series	-0.7	--	50		
	48VDC nominal input series	-0.7	--	100		
Start-up Voltage	12VDC nominal input series	--	--	9	VDC	
	24VDC nominal input series	--	--	18		
	48VDC nominal input series	--	--	36		
Input Under-voltage Protection	12VDC nominal input series	5.5	6.5	--		
	24VDC nominal input series	12	15.5	--		
	48VDC nominal input series	25	30.5	--		
Input Filter		PI filter				
Hot Plug		Unavailable				
Ctrl *	Module on	Ctrl pin open or pulled high (3.5-12VDC)				
	Module off	Ctrl pin pulled low to GND (0-1.2VDC)				
	Input current when off	--	6	10	mA	

Note: *The voltage of Ctrl pin is relative to input pin GND.

Output Specifications

Item	Operating Conditions	Min.	Typ.	Max.	Unit	
Voltage Accuracy ^①	0%-100% load	Positive output	--	±0.5	±2	%
		Negative output	--	±1	±3	
Linear Regulation	Full load, the input voltage is from low voltage to high voltage	Positive output	--	±0.2	±0.5	
		Negative output	--	±0.5	±1	
Load Regulation ^②	5%-100% load	Positive output	--	±0.5	±1	
		Negative output	--	±0.5	±1.5	
Cross Regulation	Dual output, main circuit with 50% load, auxiliary circuit with 25%-100% load	--	--	±5		
Transient Recovery Time		--	300	500	μs	
Transient Response Deviation	25% load step change, Nominal input voltage	3.3VDC/5VDC single output	--	±5	±8	
		others	--	±3	±5	
Temperature Coefficient	Full load	--	--	±0.03	%/°C	
Ripple & Noise ^③	20MHz bandwidth, 5%-100% load	3.3VDC/5VDC single output	--	40	80	mVp-p
		others	--	40	100	
Over-voltage Protection	Input voltage range	110	--	160	%Vo	
Over-current Protection	Input voltage range	3.3VDC/5VDC single output	110	160	230	%Io
		others	110	140	190	
Short-circuit Protection	Input voltage range	Continuous, self-recovery				

Notes:
 ① At 0% -5% load, the Max. output voltage accuracy of $\pm 5\text{VDC}$ output converter is $\pm 5\%$, the Max. output voltage accuracy of 3.3VDC 5VDC output converter is $\pm 3\%$;
 ② Load regulation for 0% -100% load increases to $\pm 5\%$;
 ③ Under 0% -5% load conditions, ripple & noise does not exceed 5%Vo. The "parallel cable" method is used for ripple and noise test, please refer to DC-DC Converter Application Notes for specific information. Ripple & Noise at <5% load is 5%Vo max.

General Specifications

Item	Operating Conditions	Min.	Typ.	Max.	Unit
Isolation	Input-output Electric Strength Test for 1 minute with a leakage current of 1mA max.	1500	--	--	VDC
Insulation Resistance	Input-output resistance at 500VDC	1000	--	--	M Ω
Isolation Capacitance	Input-output capacitance at 100kHz/0.1V	--	2000	--	pF
Operating Temperature	see Fig. 1	-40	--	+85	°C
Storage Temperature		-55	--	+125	
Storage Humidity	Non-condensing	5	--	95	%RH
Pin Soldering Resistance Temperature	Welding spot is 1.5mm away from the casing, 10 seconds	--	--	+300	°C
Vibration		10-150Hz, 5G, 0.75mm. along X, Y and Z			
Switching Frequency *	PWM mode	--	350	--	kHz
MTBF	MIL-HDBK-217F@25°C	1000	--	--	k hours

Note: *Switching frequency is measured at full load. The module reduces the switching frequency for light load (below 50%) efficiency improvement.

Mechanical Specifications

Case Material	Aluminum alloy
Dimensions	32.00 x 20.00 x 10.80mm
Weight	12.0g(Typ.)
Cooling Method	Free air convection

Electromagnetic Compatibility (EMC)

Emissions	CE	CISPR32/EN55032	CLASS A (without external components)/ CLASS B (see Fig.3-② for recommended circuit)
	RE	CISPR32/EN55032	CLASS A (without external components)/ CLASS B (see Fig.3-② for recommended circuit)
Immunity	ESD	IEC/EN61000-4-2	Contact $\pm 4\text{kV}$ perf. Criteria B
	RS	IEC/EN61000-4-3	10V/m perf. Criteria A
	EFT	IEC/EN61000-4-4	$\pm 2\text{kV}$ (see Fig.3-① for recommended circuit) perf. Criteria B
	Surge	IEC/EN61000-4-5	line to line $\pm 2\text{kV}$ (see Fig.3-① for recommended circuit) perf. Criteria B
	CS	IEC/EN61000-4-6	10 Vr.m.s perf. Criteria A
	Immunities of voltage dip, drop and short interruption	IEC/EN61000-4-29	0%, 70% perf. Criteria B

Typical Characteristic Curves

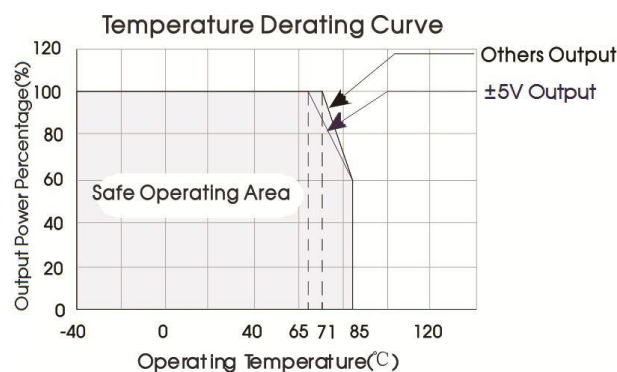
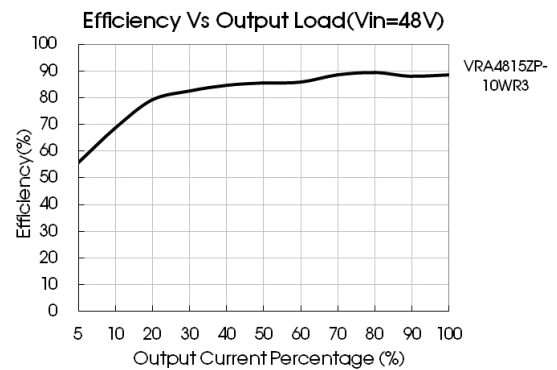
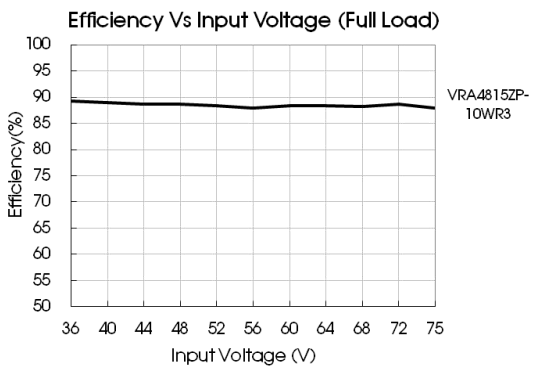
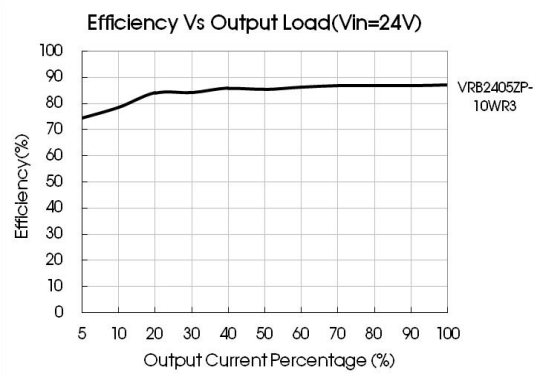
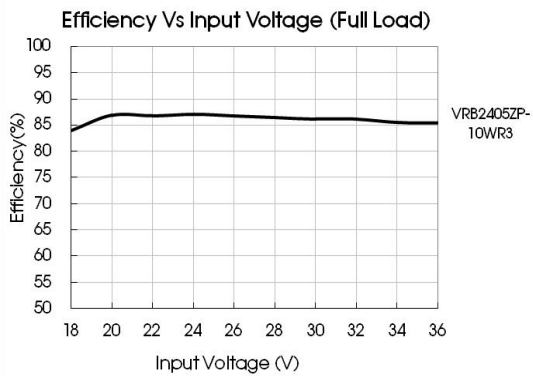
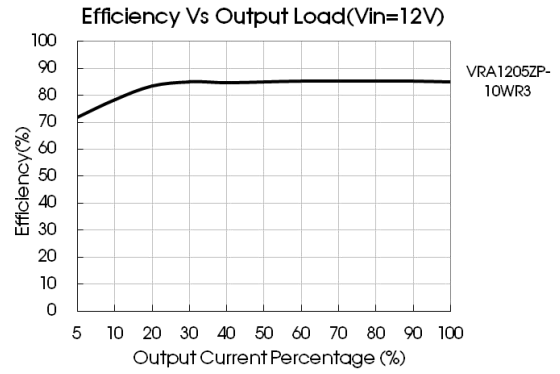
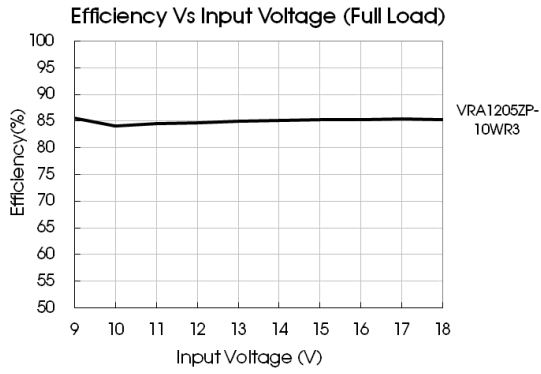

Fig. 1



Design Reference

1. Typical application

All DC-DC converters of this series are tested before delivery using the recommended circuit shown in Fig. 2.

Input and/or output ripple can be further reduced by appropriately increasing the input & output capacitor values C_{in} and C_{out} and/or by selecting capacitors with a low ESR (equivalent series resistance). Also make sure that the capacitance is not exceeding the max. capacitive load value of the product.

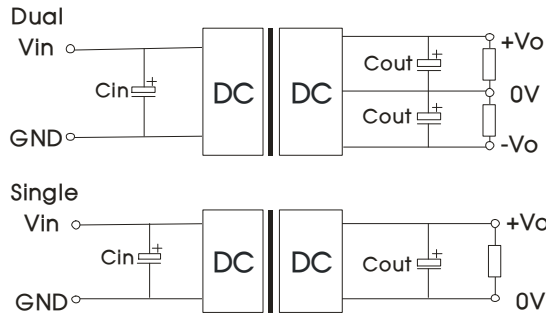
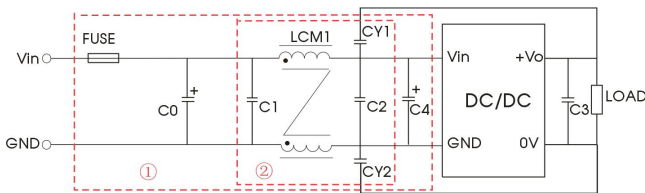

Fig. 2

Vin(VDC)	Vout(VDC)	Cin	Cout
12	3.3/5/±5	100µF/35V	10µF/16V
	12/15/±12/±15		10µF/25V
	24		10µF/50V
24	3.3/5/±5	100µF/50V	10µF/16V
	12/15/±12/±15		10µF/25V
	24		10µF/50V
48	3.3/5/±5	10µF ~47µF/100V	10µF/16V
	12/15/±12/±15		10µF/25V
	24		10µF/50V

2. EMC solution-recommended circuit

3.3VDC/5VDC single output:



Others:

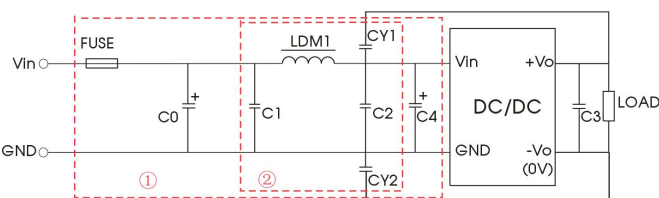

Fig. 3

Note: Part ① in the Fig. 3 is used for EMC test and part ② for emissions filtering; Selecting based on needs.

Parameter description:

Model	Vin: 12VDC	Vin: 24VDC	Vin: 48VDC
FUSE	Selected based on the actual input current in application		
C0, C4	470µF/35V	330µF/50V	330µF/100V
C1, C2	10µF/50V		10µF/100V
C3	Refer to the Cout in Fig.2		
LDM1	10µH		
LCM1	1.4-1.7mH (TN150P-RH12.7*12.7*7.9)		
CY1, CY2	1nF/2kV		

3. The products do not support parallel connection of their output

4. For additional information please refer to DC-DC converter application notes on www.mornsun-power.com

Dimensions and Recommended Layout

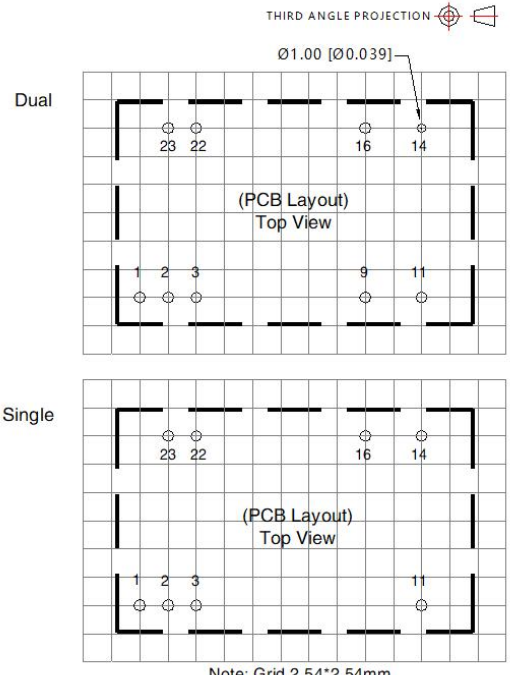
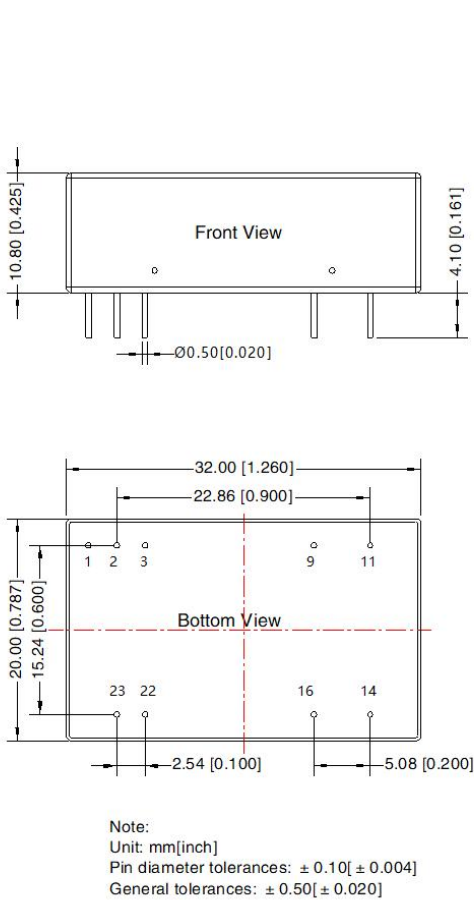

Pin	Pin-Out	
	Single	Dual
1	Ctrl	Ctrl
2,3	GND	GND
9	No Pin	0V
11	NC	-Vo
14	+Vo	+Vo
16	0V	0V
22,23	Vin	Vin

NC: Pin to be isolated from circuit

Notes:

- For additional information on Product Packaging please refer to www.mornsun-power.com. Packaging bag number: 58210008;
- The maximum capacitive load offered were tested at input voltage range and full load;
- Unless otherwise specified, parameters in this datasheet were measured under the conditions of $T_a=25^\circ\text{C}$, humidity<75%RH with nominal input voltage and rated output load;
- All index testing methods in this datasheet are based on company corporate standards;
- We can provide product customization service, please contact our technicians directly for specific information;
- Products are related to laws and regulations: see "Features" and "EMC";
- Our products shall be classified according to ISO14001 and related environmental laws and regulations, and shall be handled by qualified units.

Mornsun Guangzhou Science & Technology Co., Ltd.

Address: No. 5, Kehui St. 1, Kehui Development Center, Science Ave., Guangzhou Science City, Huangpu District, Guangzhou, P. R. China
Tel: 86-20-38601850 Fax: 86-20-38601272 E-mail: info@mornsun.cn www.mornsun-power.com