



LIGITEK ELECTRONICS CO.,LTD.
Property of Ligitek Only

FLASH ROUND TYPE LED LAMPS



Lead-Free Parts

LFSR3933-PF

DATA SHEET

DOC. NO : QW0905-LFSR3933-PF

REV. : A

DATE : 21 - Mar. - 2021

Package Dimensions

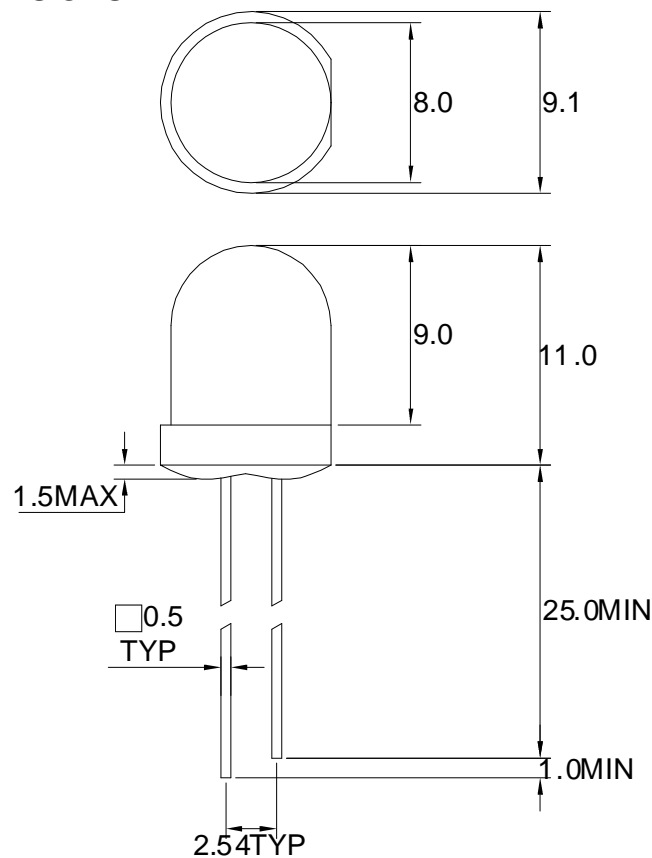

Note: 1. All dimension are in millimeter tolerance is $\pm 0.25\text{mm}$ unless other wise noted.
2. Specifications are subject to change without notice.

Features

- . Built-in IC chip flashes lamps on and off to attract attention
- . Pulse rate 2.4Hz
- . 8mm size
- . 1 inch leads
- . Large full flood radiating area
- . IC compatible

Description

The LFSR3933-PF series is a solid state lamp with a water clear plastic lens. The built-in IC flashes the lamp on/off and can be driven directly by standard TTL and CMOS circuit eliminating the need for external switching circuitry.

Absolute Maximum Ratings at Ta=25 °C

| Parameter | Symbol | Ratings | UNIT |
|---|--------|------------|------|
| | | SR | |
| Peak Forward Current(1/4) Duty cycle | IFP | 60 | mA |
| Operating Voltage | Vopr | 10 | V |
| Reverse Voltage | Vr | 0.4 | V |
| Operating Temperature | Topr | -0 ~ +85 | °C |
| Storage Temperature | Tstg | -20 ~ +100 | °C |

Typical Electrical & Optical Characteristics (Ta=25 °C)

| PART NO | MATERIAL | COLOR | | Dominant wave length λ Pnm | Spectral halfwidth $\Delta \lambda$ nm | Pulse rate(Hz) vd t=5v | | Luminous intensity volt=5v(mcd) | | Operating Voltage | |
|-------------|----------|---------|-------------|---------------------------------------|---|---------------------------|------|------------------------------------|------|-------------------|------|
| | | Emitted | Lens | | | Min. | Max. | Min. | Typ. | Min. | Max. |
| LFSR3933-PF | GaAIAs | Red | Water Clear | 660 | 20 | 2.0 | 3.0 | 50 | 90 | 3.0 | 12 |

Note : 1. The forward voltage data did not including $\pm 0.1V$ testing tolerance.
2. The luminous intensity data did not including $\pm 15\%$ testing tolerance.

Typical Electro-Optical Characteristics Curve

SR CHIP

Fig.1 Forward current vs. Forward Voltage

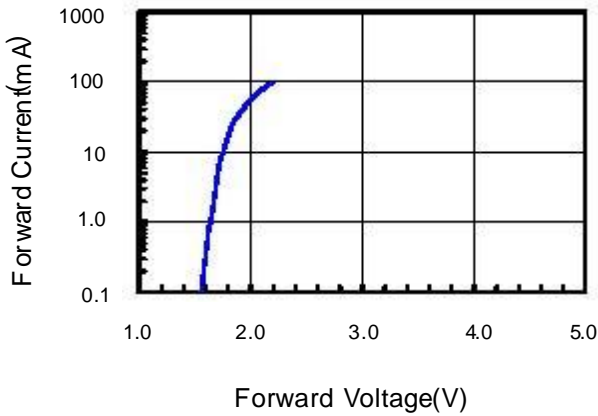

Fig.2 Relative Intensity vs. Forward Current

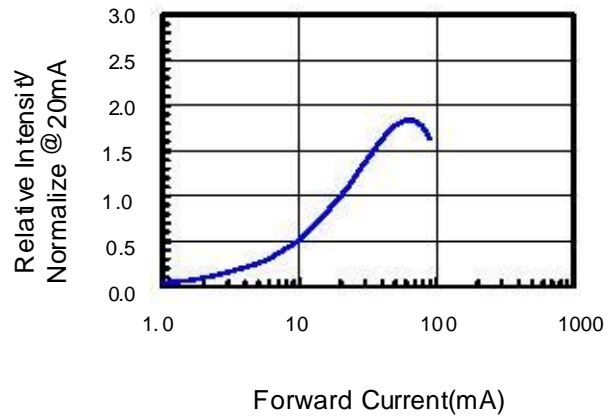

Fig.3 Forward Voltage vs. Temperature

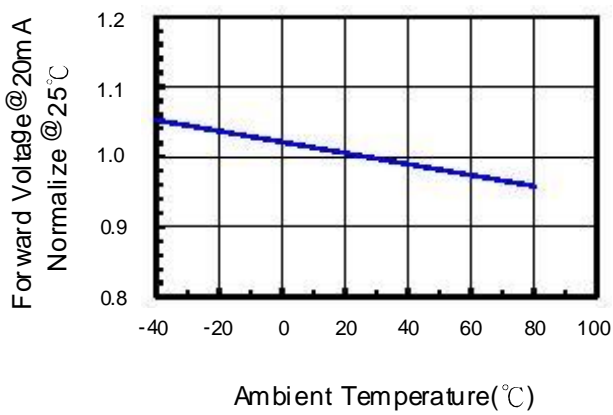

Fig.4 Relative Intensity vs. Temperature

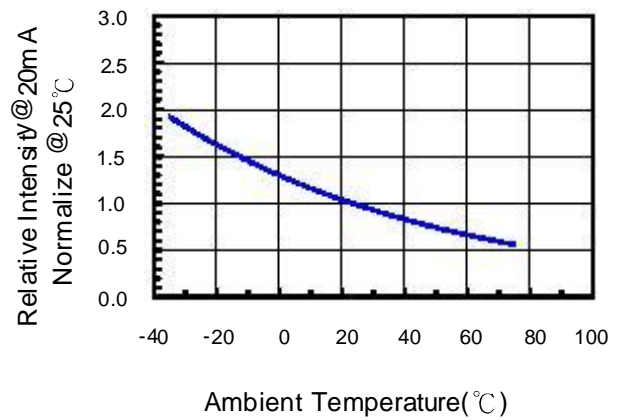
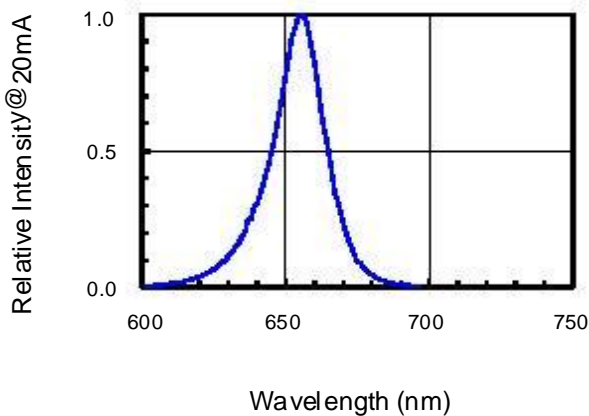

Fig.5 Relative Intensity vs. Wavelength



Soldering Condition(Pb-Free)**1.Iron:**

Soldering Iron:30W Max
Temperature 350° C Max
Soldering Time:3 Seconds Max(One time only)
Distance:2mm Min(From solder joint to body)

2.Wave Soldering Profile

Dip Soldering
Preheat: 120° C Max
Preheat time: 60seconds Max
Ramp-up
2° C/sec(max)
Ramp-Down:-5° C/sec(max)
Solder Bath:260° C Max
Dipping Time:3 seconds Max
Distance:2mm Min(From solder joint to body)

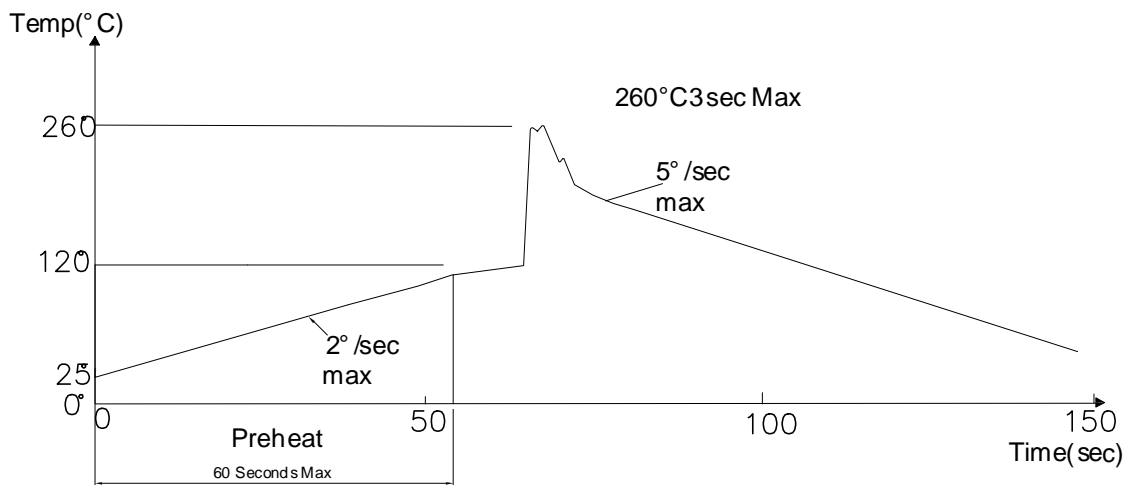

Note: 1.Wave solder should not be made more than one time.
2.You can just only select one of the soldering conditions as above.

Reliability Test:

| Test Item | Test Condition | Description | Reference Standard |
|-------------------------------------|---|---|--|
| Operating Life Test | 1. Under Room Temperature 2. If=20mA 3. t=1000 hrs (-24hrs, +72hrs) | This test is conducted for the purpose of determining the resistance of a part in electrical and thermal stressed. | MIL-STD-750: 1026 MIL-STD-883: 1005 JIS C 7021: B-1 |
| High Temperature Storage Test | 1. Ta=105 °C ±5 °C 2. t=1000 hrs (-24hrs, +72hrs) | The purpose of this is the resistance of the device which is laid under condition of high temperature for hours. | MIL-STD-883:1008 JIS C 7021: B-10 |
| Low Temperature Storage Test | 1. Ta=-40 °C ±5 °C 2. t=1000 hrs (-24hrs, +72hrs) | The purpose of this is the resistance of the device which is laid under condition of low temperature for hours. | JIS C 7021: B-12 |
| High Temperature High Humidity Test | 1. Ta=65 °C ±5 °C 2. RH=90%~95% 3. t=240hrs ±2hrs | The purpose of this test is the resistance of the device under tropical for hours. | MIL-STD-202:103B JIS C 7021: B-11 |
| Thermal Shock Test | 1. Ta=105 °C ±5 °C & -40 °C ±5 °C (10min) (10min) 2. total 10 cycles | The purpose of this is the resistance of the device to sudden extreme changes in high and low temperature. | MIL-STD-202: 107D MIL-STD-750: 1051 MIL-STD-883: 1011 |
| Solder Resistance Test | 1. T. Sol=260 °C ±5 °C 2. Dwell time= 10 ±1 sec. | This test intended to determine the thermal characteristic resistance of the device to sudden exposures at extreme changes in temperature when soldering the lead wire. | MIL-STD-202: 210A MIL-STD-750: 2031 JIS C 7021: A-1 |
| Solderability Test | 1. T. Sol=245 °C ±5 °C 2. Dwell time=5 ±1 sec | This test intended to see soldering well performed or not. | MIL-STD-202: 208D MIL-STD-750: 2026 MIL-STD-883: 2003 JIS C 7021: A-2 |