

## **LM4906 Boomer® Audio Power Amplifier Series 1W, Bypass-Capacitor-less Audio Amplifier with Internal Selectable Gain**

Check for Samples: [LM4906](#), [LM4906LDBD](#), [LM4906MMBD](#)

### **FEATURES**

- **Selectable Gain of 6dB (2V/V) or 12dB (4V/V)**
- **No Output or PSRR Bypass Capacitors Required**
- **Improved “Click and Pop” Suppression Circuitry**
- **Very Fast Turn on Time: 5ms (Typ)**
- **Minimum External Components**
- **2.6 - 5.5V Operation**
- **BTL Output Can Drive Capacitive Loads**
- **Ultra Low Current Shutdown Mode (SD Low)**

### **APPLICATIONS**

- **Portable Computers**
- **Desktop Computers**
- **Multimedia Monitors**

### **KEY SPECIFICATIONS**

- **Improved PSRR at 217Hz for +3V: 71 dB**
- **Power Output at +5V, THD+N = 1%, 8Ω: 1.0 W (Typ)**
- **Power Output at +3V, THD+N = 1%, 8Ω: 390 mW (Typ)**
- **Total Shutdown Power Supply Current: 0.1μA (Typ)**

### **DESCRIPTION**

The LM4906 is an audio power amplifier primarily designed for demanding applications in mobile phones and other portable communication device applications. It is capable of delivering 1W of continuous average power to an 8Ω BTL load with less than 1% distortion (THD+N) from a +5V power supply.

The LM4906 is the first Texas Instruments Boomer Power Amplifier that does not require an external PSRR bypass capacitor. The LM4906 also has an internal selectable gain of either 6dB or 12dB. In addition, no output coupling capacitors or bootstrap capacitors are required which makes the LM4906 ideally suited for cell phone and other low voltage portable applications.

The LM4906 contains advanced pop and click circuitry that eliminates noise, which would otherwise occur during turn-on and turn-off transitions.

Boomer audio power amplifiers were designed specifically to provide high quality output power with a minimal amount of external components. The LM4906 features a low -power consumption shutdown mode (the part is enabled by pulling the SD pin high). Additionally, the LM4906 features an internal thermal shutdown protection mechanism.



Please be aware that an important notice concerning availability, standard warranty, and use in critical applications of Texas Instruments semiconductor products and disclaimers thereto appears at the end of this data sheet.

All trademarks are the property of their respective owners.

### Typical Application

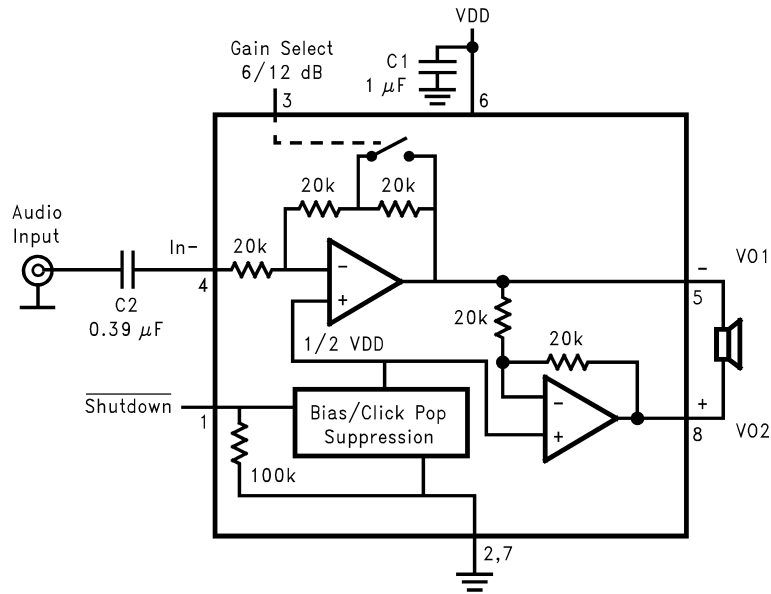

Figure 1. Typical Audio Amplifier Application Circuit

### Connection Diagram

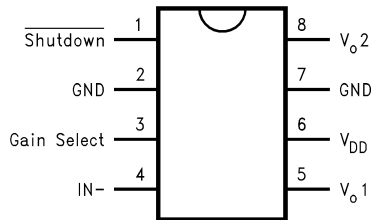

Figure 2. VSSOP Package (Top View)  
See Package Number DGK

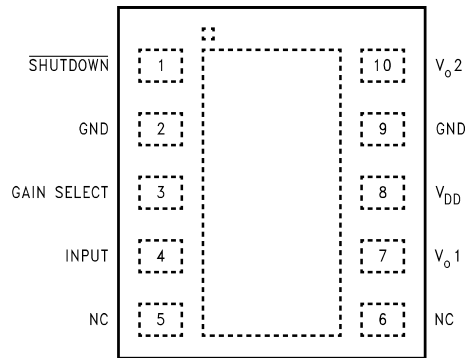

Figure 3. WSON Package (Top View)  
See Package Number NGZ

### LM4906GR Pin Designation

Pin (Bump) Number	Pin Function
A1	Shutdown
A2	No Connect
A3	V <sub>O2</sub>
A4	No Connect
B1	GND
B2	No Connect
B3	GND
B4	GND
C1	Gain Select
C2	IN
C3	No Connect

**LM4906GR Pin Designation (continued)**

C4	V <sub>DD</sub>
D1	No Connect
D2	No Connect
D3	V <sub>O1</sub>
D4	V <sub>DD</sub>

**Absolute Maximum Ratings<sup>(1)(2)</sup>**

Supply Voltage <sup>(3)</sup>	6.0V	
Storage Temperature	–65°C to +150°C	
Input Voltage	–0.3V to V <sub>DD</sub> +0.3V	
Power Dissipation <sup>(4)(5)</sup>	Internally Limited	
ESD Susceptibility <sup>(6)</sup>	2000V	
ESD Susceptibility <sup>(7)</sup>	200V	
Junction Temperature	150°C	
Thermal Resistance	$\theta_{JC}$ (VSSOP)	56°C/W
	$\theta_{JA}$ (VSSOP)	190°C/W
	$\theta_{JC}$ (WSON)	12°C/W
	$\theta_{JA}$ (WSON)	63°C/W

- (1) Absolute Maximum Ratings indicate limits beyond which damage to the device may occur. Operating Ratings indicate conditions for which the device is functional, but do not ensure specific performance limits. Electrical Characteristics state DC and AC electrical specifications under particular test conditions which ensure specific performance limits. This assumes that the device is within the Operating Ratings. Specifications are not ensured for parameters where no limit is given; however, the typical value is a good indication of device performance.
- (2) If Military/Aerospace specified devices are required, please contact the Texas Instruments Sales Office/ Distributors for availability and specifications.
- (3) If the product is in Shutdown mode and V<sub>DD</sub> exceeds 6V (to a max of 8V V<sub>DD</sub>), then most of the excess current will flow through the ESD protection circuits. If the source impedance limits the current to a max of 10mA, then the device will be protected. If the device is enabled when V<sub>DD</sub> is greater than 5.5V and less than 6.5V, no damage will occur, although operation life will be reduced. Operation above 6.5V with no current limit will result in permanent damage.
- (4) The maximum power dissipation must be derated at elevated temperatures and is dictated by T<sub>JMAX</sub>,  $\theta_{JA}$ , and the ambient temperature T<sub>A</sub>. The maximum allowable power dissipation is P<sub>DMAX</sub> = (T<sub>JMAX</sub> – T<sub>A</sub>)/ $\theta_{JA}$  or the number given in Absolute Maximum Ratings, whichever is lower. For the LM4906, see [Figure 10](#) for additional information.
- (5) Maximum power dissipation in the device (P<sub>DMAX</sub>) occurs at an output power level significantly below full output power. P<sub>DMAX</sub> can be calculated using [Equation 1](#) shown in the [Application Information](#) section. It may also be obtained from the power dissipation graphs.
- (6) Human body model, 100pF discharged through a 1.5k $\Omega$  resistor.
- (7) Machine Model, 220pF–240pF discharged through all pins.

**Operating Ratings**

Temperature Range	T <sub>MIN</sub> ≤ T <sub>A</sub> ≤ T <sub>MAX</sub>	–40°C ≤ T <sub>A</sub> ≤ 85°C
Supply Voltage		2.6V ≤ V <sub>DD</sub> ≤ 5.5V

**Electrical Characteristics  $V_{DD} = 5V^{(1)(2)}$** 

The following specifications apply for the circuit shown in [Figure 1](#), unless otherwise specified. Limits apply for  $T_A = 25^\circ C$ .

Symbol	Parameter	Conditions	LM4906		Units (Limits)
			Typical <sup>(3)</sup>	Limit <sup>(4)(5)</sup>	
$I_{DD}$	Quiescent Power Supply Current	$V_{IN} = 0V, I_o = 0A$ , No Load	3.5	7	mA (max)
		$V_{IN} = 0V, I_o = 0A$ , $8\Omega$ Load	4	8	mA (max)
$I_{SD}$	Shutdown Current	$V_{SD} = GND$	0.1	2	$\mu A$ (max)
$V_{OS}$	Output Offset Voltage		7	35	mV (max)
$P_o$	Output Power	THD+N = 1% (max); $f = 1$ kHz $R_L = 8\Omega$	1.0	0.9	W (min)
$T_{WU}$	Wake-up time		5		ms
THD+N	Total Harmonic Distortion+Noise	$P_o = 0.4$ Wrms; $f = 1$ kHz	0.2		%
PSRR	Power Supply Rejection Ratio	$V_{ripple} = 200mV$ sine p-p Input terminated with $10\Omega$ Gain at 6dB	67 ( $f = 217Hz$ ) 70 ( $f = 1kHz$ )		dB
$V_{SDIH}$	Shutdown Voltage Input High	SD Pin High = Part On	1.5		V (min)
$V_{SDIL}$	Shutdown Voltage Input Low	SD Pin Low = Part Off	1.3		V (max)

- (1) All voltages are measured with respect to the ground pin, unless otherwise specified.
- (2) Absolute Maximum Ratings indicate limits beyond which damage to the device may occur. Operating Ratings indicate conditions for which the device is functional, but do not ensure specific performance limits. Electrical Characteristics state DC and AC electrical specifications under particular test conditions which ensure specific performance limits. This assumes that the device is within the Operating Ratings. Specifications are not ensured for parameters where no limit is given; however, the typical value is a good indication of device performance.
- (3) Typicals are measured at  $25^\circ C$  and represent the parametric norm.
- (4) Datasheet min/max specification limits are specified by design, test, or statistical analysis.
- (5) Limits are specified to AOQL (Average Outgoing Quality Level).

**Electrical Characteristics  $V_{DD} = 3V^{(1)(2)}$** 

 The following specifications apply for the circuit shown in [Figure 1](#), unless otherwise specified. Limits apply for  $T_A = 25^\circ C$ .

Symbol	Parameter	Conditions	LM4906		Units (Limits)
			Typical <sup>(3)</sup>	Limit <sup>(4)(5)</sup>	
$I_{DD}$	Quiescent Power Supply Current	$V_{IN} = 0V, I_o = 0A$ , No Load	2.6	6	mA (max)
		$V_{IN} = 0V, I_o = 0A$ , $8\Omega$ Load	3	7	mA (max)
$I_{SD}$	Shutdown Current	$V_{SD} = GND$	0.1	2	$\mu A$ (max)
$V_{OS}$	Output Offset Voltage		7	35	mV (max)
$P_o$	Output Power	THD+N = 1% (max); $f = 1$ kHz $R_L = 8\Omega$	390		mW
$T_{WU}$	Wake-up time		4		ms
THD+N	Total Harmonic Distortion+Noise	$P_o = 0.15$ Wrms; $f = 1$ kHz	0.1		%
PSRR	Power Supply Rejection Ratio	$V_{ripple} = 200mV$ sine p-p Input terminated with $10\Omega$ Gain at 6dB	71 ( $f = 217Hz$ ) 73 ( $f = 1kHz$ )		dB
$V_{SDIH}$	Shutdown Voltage Input High	SD Pin High = Part On	1.1		V (min)
$V_{SDIL}$	Shutdown Voltage Input Low	SD Pin Low = Part Off	0.9		V (max)

- (1) Absolute Maximum Ratings indicate limits beyond which damage to the device may occur. Operating Ratings indicate conditions for which the device is functional, but do not ensure specific performance limits. Electrical Characteristics state DC and AC electrical specifications under particular test conditions which ensure specific performance limits. This assumes that the device is within the Operating Ratings. Specifications are not ensured for parameters where no limit is given; however, the typical value is a good indication of device performance.
- (2) All voltages are measured with respect to the ground pin, unless otherwise specified.
- (3) Typicals are measured at  $25^\circ C$  and represent the parametric norm.
- (4) Limits are specified to AOQL (Average Outgoing Quality Level).
- (5) Datasheet min/max specification limits are specified by design, test, or statistical analysis.

### External Components Description

Components		Functional Description
1.	$C_2$	Input coupling capacitor which blocks the DC voltage at the amplifiers input terminals. Also creates a highpass filter with $R_i$ at $f_c = 1 / (2\pi R_i C_i)$ . Refer to the section, <a href="#">AUDIO POWER AMPLIFIER DESIGN</a> , for an explanation of how to determine the value of $C_i$ .
2.	$C_1$	Supply bypass capacitor which provides power supply filtering. Refer to the <a href="#">Power Supply Bypassing</a> section for information concerning proper placement and selection of the supply bypass capacitor.

Typical Performance Characteristics

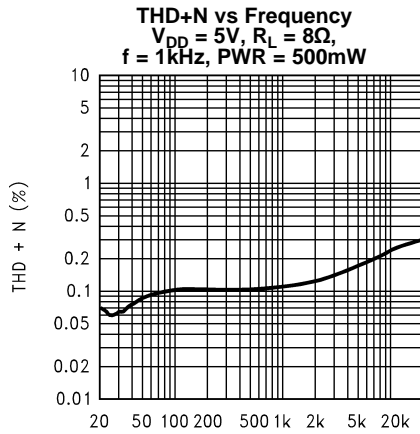

Figure 4.

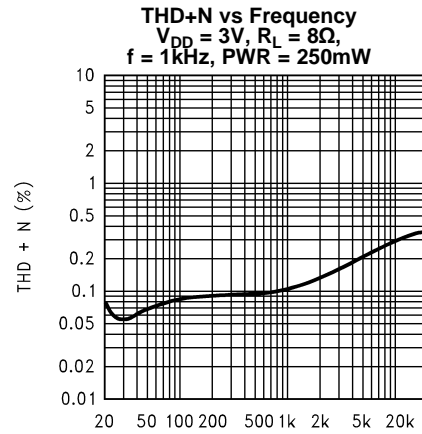

Figure 5.

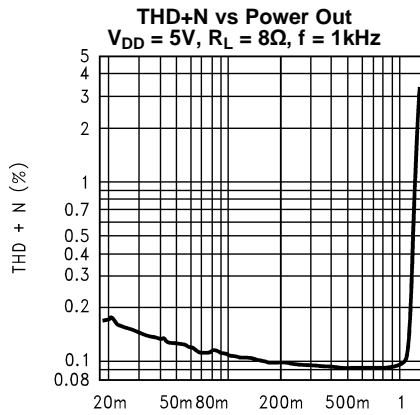

Figure 6.

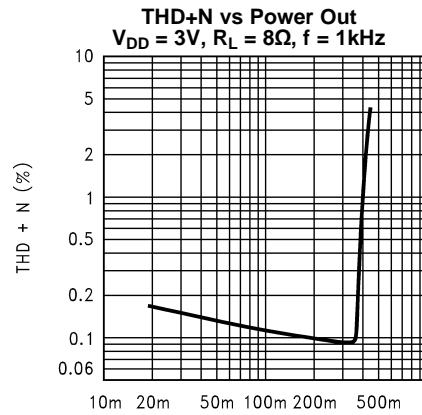

Figure 7.

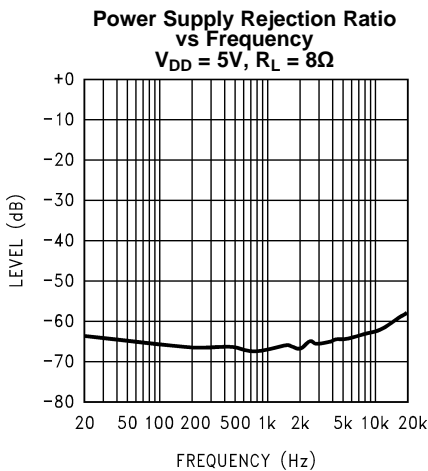

Figure 8.

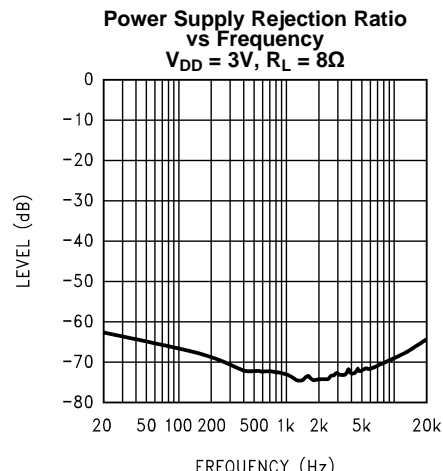

Figure 9.

Typical Performance Characteristics (continued)

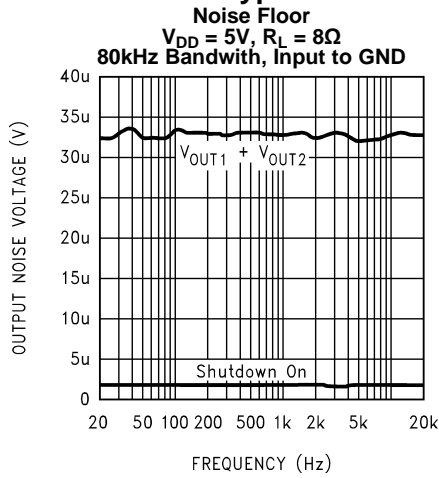

Figure 10.

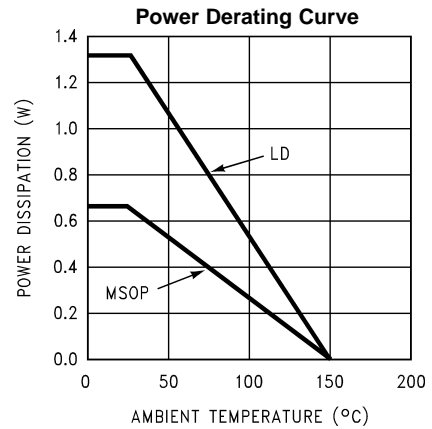

Figure 11.

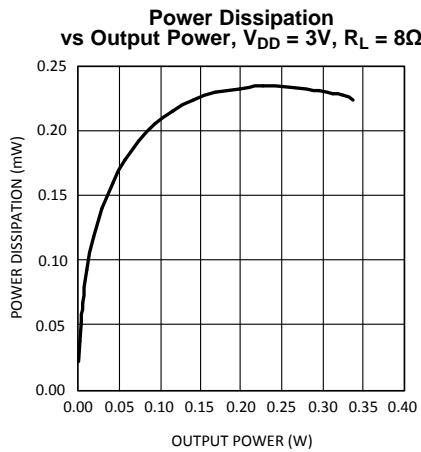

Figure 12.

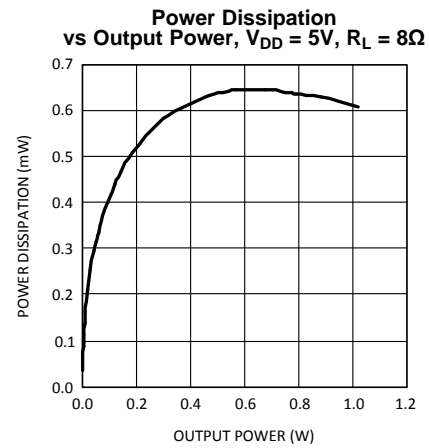

Figure 13.

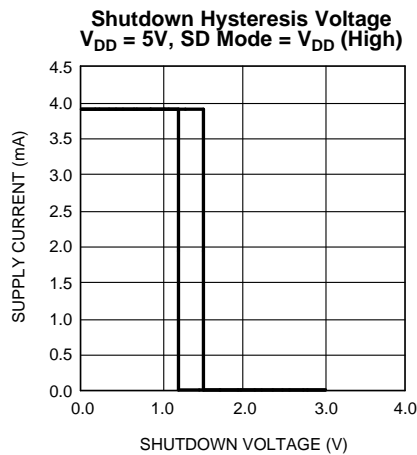

Figure 14.

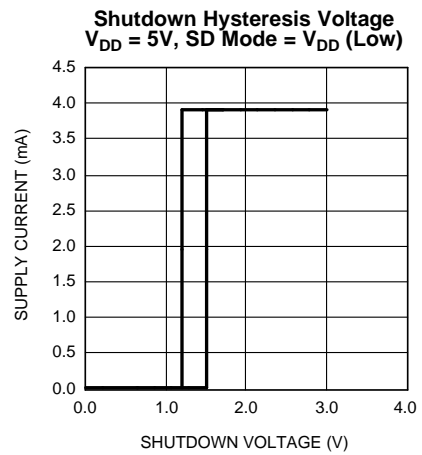

Figure 15.

**Typical Performance Characteristics (continued)**

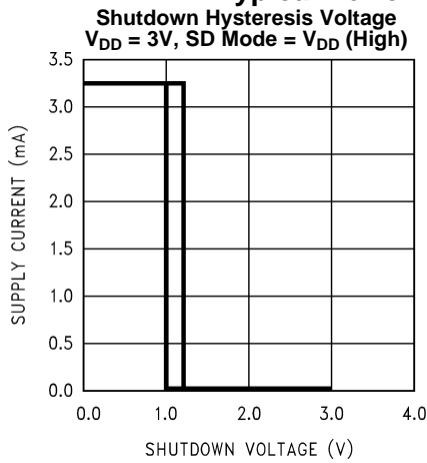

Figure 16.

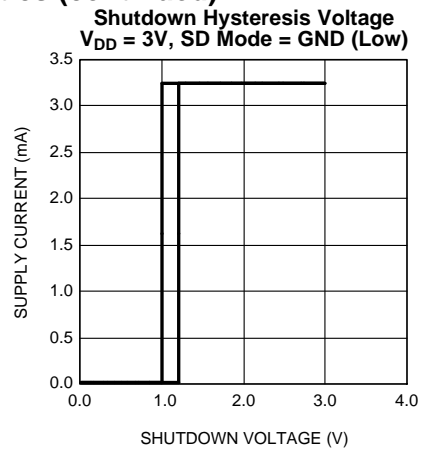

Figure 17.

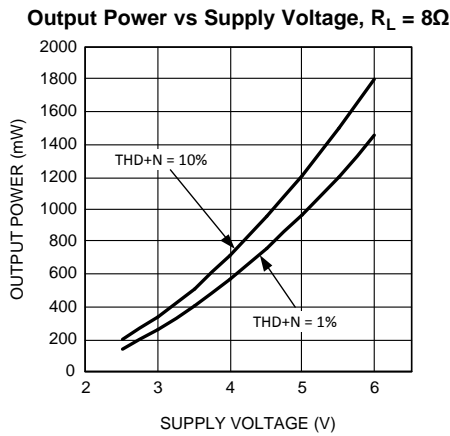

Figure 18.

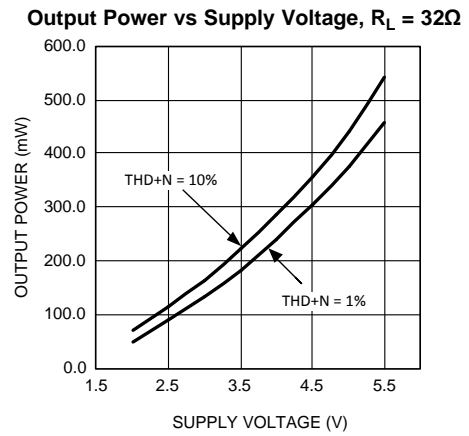

Figure 19.

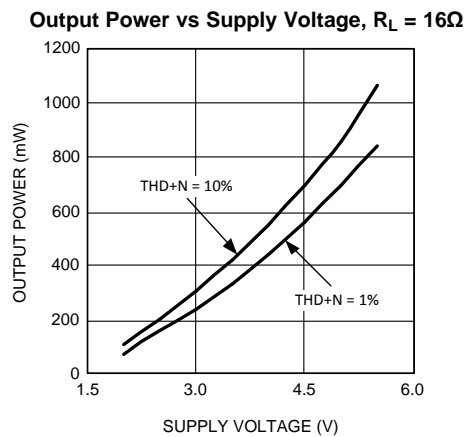

Figure 20.

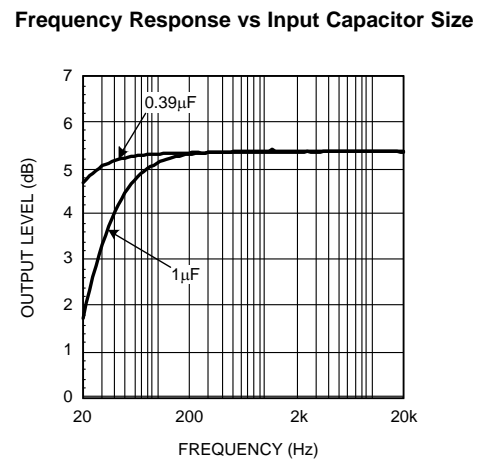

Figure 21.



**Typical Performance Characteristics (continued)**

**PSRR Distribution**  
 $V_{DD} = 5V, f = 1kHz, R_L = 8\Omega$

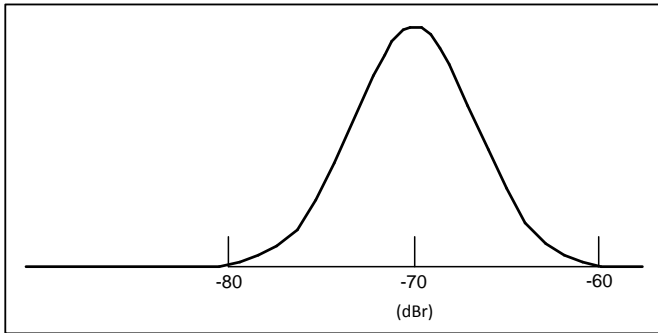

Figure 22.

**PSRR Distribution**  
 $V_{DD} = 5V, f = 217Hz, R_L = 8\Omega$

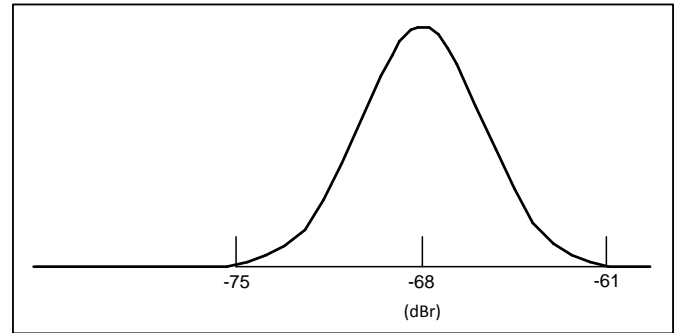

Figure 23.

**PSRR Distribution**  
 $V_{DD} = 3V, f = 1kHz, R_L = 8\Omega$

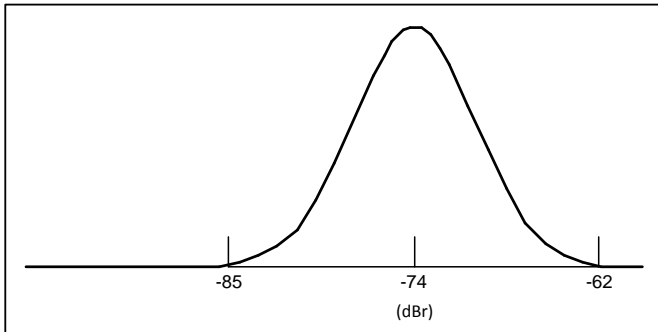

Figure 24.

**PSRR Distribution**  
 $V_{DD} = 3V, f = 217Hz, R_L = 8\Omega$

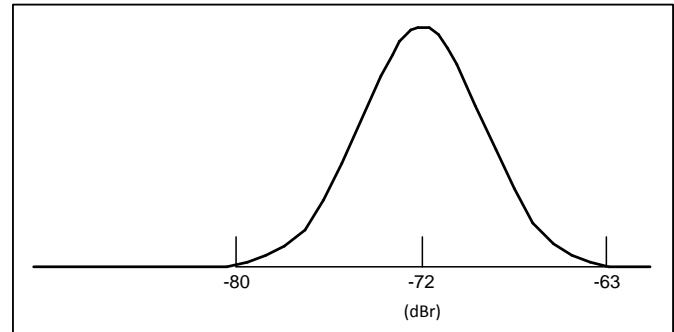

Figure 25.

## APPLICATION INFORMATION

### BRIDGE CONFIGURATION EXPLANATION

As shown in [Figure 26](#), the LM4906 has two internal operational amplifiers. The first amplifier's gain is either 6dB or 12dB depending on the gain select input (Low = 6dB, High = 12dB). The second amplifier's gain is fixed by the two internal 20kΩ resistors. [Figure 26](#) shows that the output of amplifier one serves as the input to amplifier two which results in both amplifiers producing signals identical in magnitude, but out of phase by 180°. Consequently, the differential gain for the IC is

$$A_{VD} = 2 * (20k / 20k) \text{ or } 2 * (40k / 20k) \quad (1)$$

By driving the load differentially through outputs Vo1 and Vo2, an amplifier configuration commonly referred to as “bridged mode” is established. Bridged mode operation is different from the classical single-ended amplifier configuration where one side of the load is connected to ground.

A bridge amplifier design has a few distinct advantages over the single-ended configuration, as it provides differential drive to the load, thus doubling output swing for a specified supply voltage. Four times the output power is possible as compared to a single-ended amplifier under the same conditions. This increase in attainable output power assumes that the amplifier is not current limited or clipped. In order to choose an amplifier's closed-loop gain without causing excessive clipping, please refer to the [Audio Power Amplifier Design](#) section.

A bridge configuration, such as the one used in LM4906, also creates a second advantage over single-ended amplifiers. Since the differential outputs, Vo1 and Vo2, are biased at half-supply, no net DC voltage exists across the load. This eliminates the need for an output coupling capacitor which is required in a single supply, single-ended amplifier configuration. Without an output coupling capacitor, the half-supply bias across the load would result in both increased internal IC power dissipation and also possible loudspeaker damage.

### POWER DISSIPATION

Power dissipation is a major concern when designing a successful amplifier, whether the amplifier is bridged or single-ended. A direct consequence of the increased power delivered to the load by a bridge amplifier is an increase in internal power dissipation. Since the LM4906 has two operational amplifiers in one package, the maximum internal power dissipation is 4 times that of a single-ended amplifier. The maximum power dissipation for a given application can be derived from the power dissipation graphs or from [Equation 2](#).

$$P_{DMAX} = 4 * (V_{DD})^2 / (2\pi^2 R_L) \quad (2)$$

It is critical that the maximum junction temperature  $T_{JMAX}$  of 150°C is not exceeded.  $T_{JMAX}$  can be determined from the power derating curves by using  $P_{DMAX}$  and the PC board foil area. By adding copper foil, the thermal resistance of the application can be reduced from the free air value of  $\theta_{JA}$ , resulting in higher  $P_{DMAX}$  values without thermal shutdown protection circuitry being activated. Additional copper foil can be added to any of the leads connected to the LM4906. It is especially effective when connected to  $V_{DD}$ , GND, and the output pins. Refer to the [Application Information](#) on the LM4906 reference design board for an example of good heat sinking. If  $T_{JMAX}$  still exceeds 150°C, then additional changes must be made. These changes can include reduced supply voltage, higher load impedance, or reduced ambient temperature. Internal power dissipation is a function of output power. Refer to the [Typical Performance Characteristics](#) curves for power dissipation information for different output powers and output loading.

### POWER SUPPLY BYPASSING

As with any amplifier, proper supply bypassing is critical for low noise performance and high power supply rejection. The capacitor location on the power supply pin should be as close to the device as possible. Typical applications employ a 5V regulator with 10μF tantalum or electrolytic capacitor and a ceramic bypass capacitor which aid in supply stability. This does not eliminate the need for bypassing the supply nodes of the LM4906.

## TURNING ON THE LM4906

The power supply must first be applied before the application of an input signal to the device and the ramp time to  $V_{DD}$  must be less than 4ms, otherwise the wake-up time of the device will be affected. After applying  $V_{DD}$ , the LM4906 will turn-on after an initial minimum threshold input signal of  $7mV_{RMS}$ , resulting in a generated output differential signal. An input signal of less than  $7mV_{RMS}$  will result in a negligible output voltage. Once the device is turned on, the input signal can go below the  $7mV_{RMS}$  without shutting the device off. If, however, SHUTDOWN or  $V_{DD}$  is cycled, the minimum threshold requirement for the input signal must first be met again, with  $V_{DD}$  ramping first.

## SHUTDOWN FUNCTION

In order to reduce power consumption while not in use, the LM4906 contains shutdown circuitry that is used to turn off the amplifier's bias circuitry. The device is placed into shutdown mode by toggling the Shutdown pin Low/ground. The trigger point for shutdown low is shown as a typical value in the Supply Current vs Shutdown Voltage graphs in the [Typical Performance Characteristics](#) section. It is best to switch between ground and supply for maximum performance. While the device may be disabled with shutdown voltages in between ground and supply, the idle current may be greater than the typical value of  $0.1\mu A$ . In either case, the shutdown pin should be tied to a definite voltage to avoid unwanted state changes.

In many applications, a microcontroller or microprocessor output is used to control the shutdown circuitry, which provides a quick, smooth transition to shutdown. Another solution is to use a single-throw switch in conjunction with an external pull-up resistor (or pull-down, depending on shutdown high or low application). This scheme ensures that the shutdown pin will not float, thus preventing unwanted state changes.

## SELECTION OF INPUT CAPACITOR SIZE

Large input capacitors are both expensive and space hungry for portable designs. Clearly, a certain sized capacitor is needed to couple in low frequencies without severe attenuation. But in many cases the speakers used in portable systems, whether internal or external, have little ability to reproduce signals below 100Hz to 150Hz. Thus, using a large input capacitor may not increase actual system performance.

In addition to system cost and size, click and pop performance is effected by the size of the input coupling capacitor,  $C_i$ . A larger input coupling capacitor requires more charge to reach its quiescent DC voltage (nominally  $1/2 V_{DD}$ ). This charge comes from the output via the feedback and is apt to create pops upon device enable. Thus, by minimizing the capacitor size based on necessary low frequency response, turn-on pops can be minimized.

## AUDIO POWER AMPLIFIER DESIGN

### A 1W/8Ω Audio Amplifier

Given:	Power Output	1 Wrms
	Load Impedance	8Ω
	Input Level	1 Vrms
	Input Impedance	20 kΩ
	Bandwidth	100 Hz–20 kHz ± 0.25 dB

A designer must first determine the minimum supply rail to obtain the specified output power. By extrapolating from the Output Power vs Supply Voltage graphs in the [Typical Performance Characteristics](#) section, the supply rail can be easily found.

Extra supply voltage creates headroom that allows the LM4906 to reproduce peaks in excess of 1W without producing audible distortion. At this time, the designer must make sure that the power supply choice along with the output impedance does not violate the conditions explained in the [Power Dissipation](#) section.

The gain of the LM4906 is internally set at either 6dB or 12dB.

The final design step is to address the bandwidth requirements which must be stated as a pair of  $-3\text{dB}$  frequency points. Five times away from a  $-3\text{dB}$  point is  $0.17\text{dB}$  down from passband response which is better than the required  $\pm 0.25\text{dB}$  specified.

$$f_L = 100\text{Hz} / 5 = 20\text{Hz}$$

$$f_H = 20\text{kHz} * 5 = 100\text{kHz}$$

As stated in the [External Components Description](#) section,  $R_{in}$  (20k) in conjunction with  $C_2$  create a highpass filter.

$$C_2 \geq 1 / (2\pi * 20\text{k}\Omega * 20\text{Hz}) = 0.397\mu\text{F}; \text{ use } 0.39\mu\text{F}$$

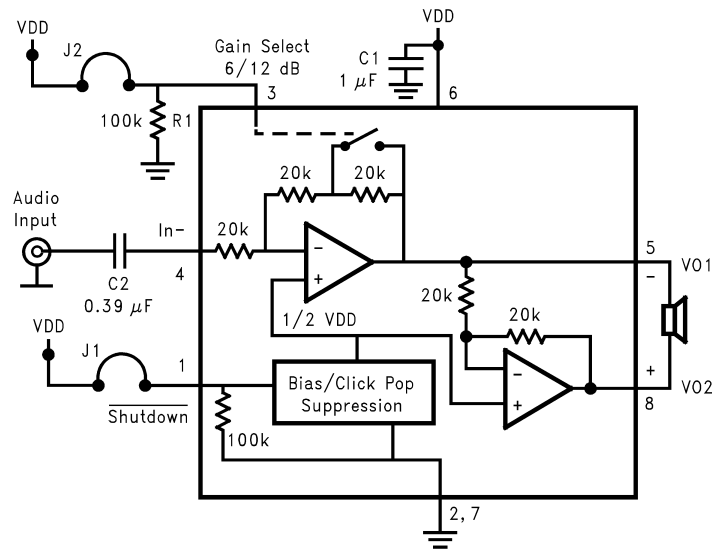

Figure 26. REFERENCE DESIGN BOARD SCHEMATIC

LM4906 VSSOP DEMO BOARD ARTWORK

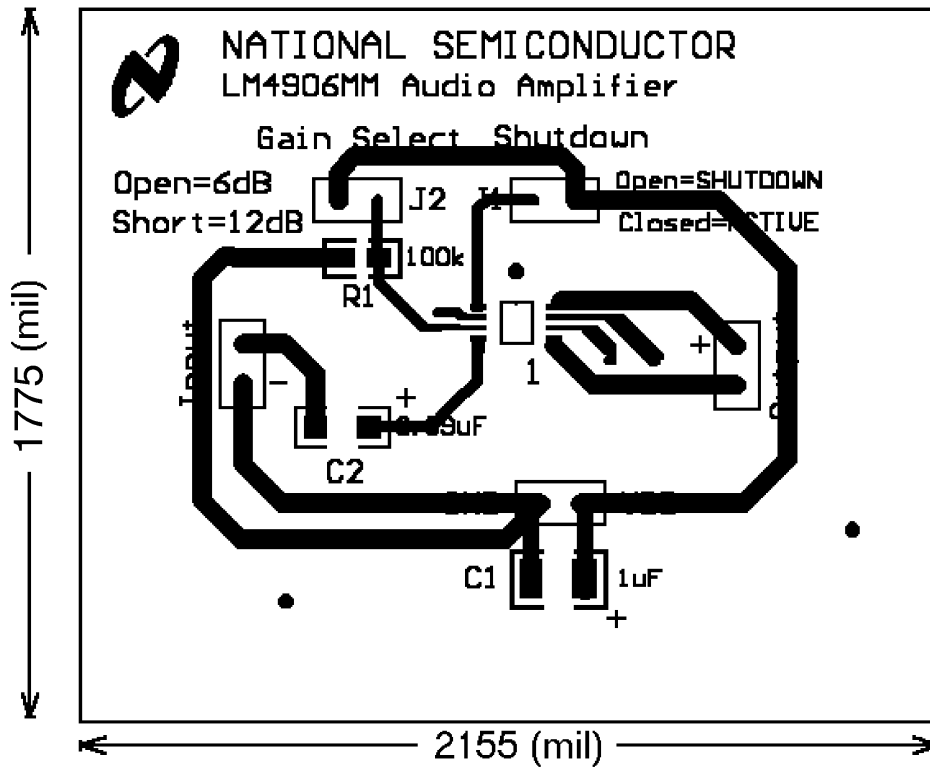

Figure 27. Top Layer

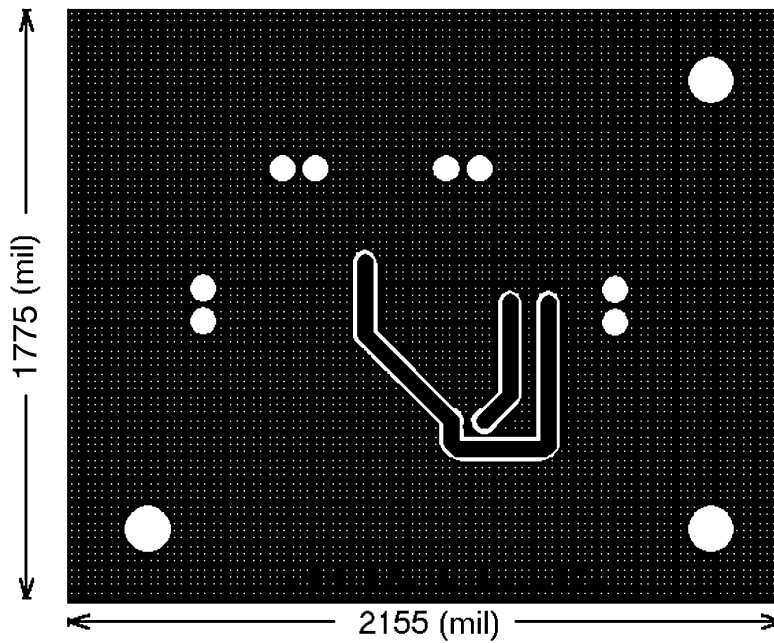

Figure 28. Bottom Layer

LM4906 LD DEMO BOARD ARTWORK

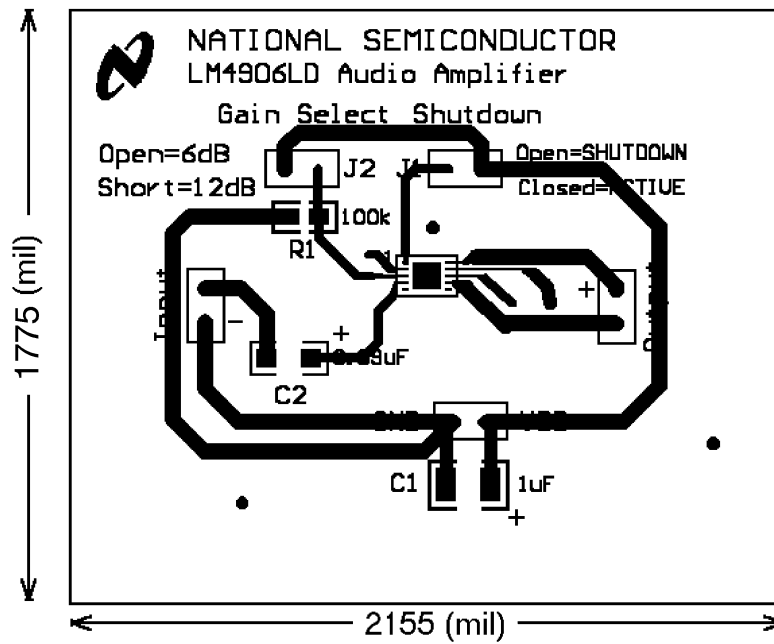

Figure 29. Top Layer

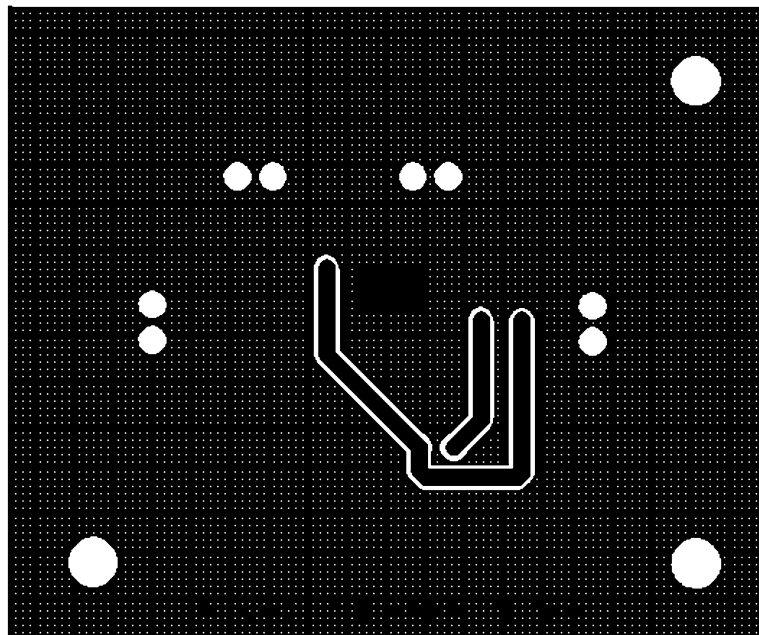

Figure 30. Bottom Layer

**Table 1. Mono LM4906 Reference Design Boards  
Bill of Material**

Part Description	Quantity	Reference Designator
LM4906 Audio Amplifier	1	U1
Tantalum Capacitor, 1 $\mu$ F	1	C1
Ceramic Capacitor, 0.39 $\mu$ F	1	C2
Jumper Header Vertical Mount 2X1 0.100" spacing	5	J1, J2, Input, Output, V <sub>DD</sub>

## PCB LAYOUT GUIDELINES

This section provides practical guidelines for mixed signal PCB layout that involves various digital/analog power and ground traces. Designers should note that these are only "rule-of-thumb" recommendations and the actual results will depend heavily on the final layout.

### GENERAL MIXED SIGNAL LAYOUT RECOMMENDATION

#### Power and Ground Circuits

For 2 layer mixed signal design, it is important to isolate the digital power and ground trace paths from the analog power and ground trace paths. Star trace routing techniques (bringing individual traces back to a central point rather than daisy chaining traces together in a serial manner) can have a major impact on low level signal performance. Star trace routing refers to using individual traces to feed power and ground to each circuit or even device. This technique will require a greater amount of design time but will not increase the final price of the board. The only extra parts required will be some jumpers.

#### Single-Point Power / Ground Connections

The analog power traces should be connected to the digital traces through a single point (link). A "Pi-filter" can be helpful in minimizing High Frequency noise coupling between the analog and digital sections. It is further recommended to put digital and analog power traces over the corresponding digital and analog ground traces to minimize noise coupling.

#### Placement of Digital and Analog Components

All digital components and high-speed digital signal traces should be located as far away as possible from analog components and circuit traces.

#### Avoiding Typical Design / Layout Problems

Avoid ground loops or running digital and analog traces parallel to each other (side-by-side) on the same PCB layer. When traces must cross over each other do it at 90 degrees. Running digital and analog traces at 90 degrees to each other from the top to the bottom side as much as possible will minimize capacitive noise coupling and cross talk.

## REVISION HISTORY

Changes from Revision D (May 2013) to Revision E	Page
• Changed layout of National Data Sheet to TI format .....	15



**PACKAGING INFORMATION**

Orderable Device	Status (1)	Package Type	Package Drawing	Pins	Package Qty	Eco Plan (2)	Lead/Ball Finish	MSL Peak Temp (3)	Op Temp (°C)	Top-Side Markings (4)	Samples
LM4906MM/NOPB	ACTIVE	VSSOP	DGK	8	1000	Green (RoHS & no Sb/Br)	CU SN	Level-1-260C-UNLIM	-40 to 85	GA8	Samples

(1) The marketing status values are defined as follows:

**ACTIVE:** Product device recommended for new designs.

**LIFEBUY:** TI has announced that the device will be discontinued, and a lifetime-buy period is in effect.

**NRND:** Not recommended for new designs. Device is in production to support existing customers, but TI does not recommend using this part in a new design.

**PREVIEW:** Device has been announced but is not in production. Samples may or may not be available.

**OBSOLETE:** TI has discontinued the production of the device.

(2) Eco Plan - The planned eco-friendly classification: Pb-Free (RoHS), Pb-Free (RoHS Exempt), or Green (RoHS & no Sb/Br) - please check <http://www.ti.com/productcontent> for the latest availability information and additional product content details.

**TBD:** The Pb-Free/Green conversion plan has not been defined.

**Pb-Free (RoHS):** TI's terms "Lead-Free" or "Pb-Free" mean semiconductor products that are compatible with the current RoHS requirements for all 6 substances, including the requirement that lead not exceed 0.1% by weight in homogeneous materials. Where designed to be soldered at high temperatures, TI Pb-Free products are suitable for use in specified lead-free processes.

**Pb-Free (RoHS Exempt):** This component has a RoHS exemption for either 1) lead-based flip-chip solder bumps used between the die and package, or 2) lead-based die adhesive used between the die and leadframe. The component is otherwise considered Pb-Free (RoHS compatible) as defined above.

**Green (RoHS & no Sb/Br):** TI defines "Green" to mean Pb-Free (RoHS compatible), and free of Bromine (Br) and Antimony (Sb) based flame retardants (Br or Sb do not exceed 0.1% by weight in homogeneous material)

(3) MSL, Peak Temp. -- The Moisture Sensitivity Level rating according to the JEDEC industry standard classifications, and peak solder temperature.

(4) Multiple Top-Side Markings will be inside parentheses. Only one Top-Side Marking contained in parentheses and separated by a "~" will appear on a device. If a line is indented then it is a continuation of the previous line and the two combined represent the entire Top-Side Marking for that device.

**Important Information and Disclaimer:** The information provided on this page represents TI's knowledge and belief as of the date that it is provided. TI bases its knowledge and belief on information provided by third parties, and makes no representation or warranty as to the accuracy of such information. Efforts are underway to better integrate information from third parties. TI has taken and continues to take reasonable steps to provide representative and accurate information but may not have conducted destructive testing or chemical analysis on incoming materials and chemicals. TI and TI suppliers consider certain information to be proprietary, and thus CAS numbers and other limited information may not be available for release.

In no event shall TI's liability arising out of such information exceed the total purchase price of the TI part(s) at issue in this document sold by TI to Customer on an annual basis.

## TAPE AND REEL INFORMATION



### QUADRANT ASSIGNMENTS FOR PIN 1 ORIENTATION IN TAPE



\*All dimensions are nominal

Device	Package Type	Package Drawing	Pins	SPQ	Reel Diameter (mm)	Reel Width W1 (mm)	A0 (mm)	B0 (mm)	K0 (mm)	P1 (mm)	W (mm)	Pin1 Quadrant
LM4906MM/NOPB	VSSOP	DGK	8	1000	178.0	12.4	5.3	3.4	1.4	8.0	12.0	Q1

**TAPE AND REEL BOX DIMENSIONS**



\*All dimensions are nominal

Device	Package Type	Package Drawing	Pins	SPQ	Length (mm)	Width (mm)	Height (mm)
LM4906MM/NOPB	VSSOP	DGK	8	1000	210.0	185.0	35.0

DGK (S-PDSO-G8)

PLASTIC SMALL-OUTLINE PACKAGE



- NOTES:
- A. All linear dimensions are in millimeters.
  - B. This drawing is subject to change without notice.
  - C. Body length does not include mold flash, protrusions, or gate burrs. Mold flash, protrusions, or gate burrs shall not exceed 0.15 per end.
  - D. Body width does not include interlead flash. Interlead flash shall not exceed 0.50 per side.
  - E. Falls within JEDEC MO-187 variation AA, except interlead flash.



- NOTES:
- A. All linear dimensions are in millimeters.
  - B. This drawing is subject to change without notice.
  - C. Publication IPC-7351 is recommended for alternate designs.
  - D. Laser cutting apertures with trapezoidal walls and also rounding corners will offer better paste release. Customers should contact their board assembly site for stencil design recommendations. Refer to IPC-7525 for other stencil recommendations.
  - E. Customers should contact their board fabrication site for solder mask tolerances between and around signal pads.

## IMPORTANT NOTICE

Texas Instruments Incorporated and its subsidiaries (TI) reserve the right to make corrections, enhancements, improvements and other changes to its semiconductor products and services per JESD46, latest issue, and to discontinue any product or service per JESD48, latest issue. Buyers should obtain the latest relevant information before placing orders and should verify that such information is current and complete. All semiconductor products (also referred to herein as "components") are sold subject to TI's terms and conditions of sale supplied at the time of order acknowledgment.

TI warrants performance of its components to the specifications applicable at the time of sale, in accordance with the warranty in TI's terms and conditions of sale of semiconductor products. Testing and other quality control techniques are used to the extent TI deems necessary to support this warranty. Except where mandated by applicable law, testing of all parameters of each component is not necessarily performed.

TI assumes no liability for applications assistance or the design of Buyers' products. Buyers are responsible for their products and applications using TI components. To minimize the risks associated with Buyers' products and applications, Buyers should provide adequate design and operating safeguards.

TI does not warrant or represent that any license, either express or implied, is granted under any patent right, copyright, mask work right, or other intellectual property right relating to any combination, machine, or process in which TI components or services are used. Information published by TI regarding third-party products or services does not constitute a license to use such products or services or a warranty or endorsement thereof. Use of such information may require a license from a third party under the patents or other intellectual property of the third party, or a license from TI under the patents or other intellectual property of TI.

Reproduction of significant portions of TI information in TI data books or data sheets is permissible only if reproduction is without alteration and is accompanied by all associated warranties, conditions, limitations, and notices. TI is not responsible or liable for such altered documentation. Information of third parties may be subject to additional restrictions.

Resale of TI components or services with statements different from or beyond the parameters stated by TI for that component or service voids all express and any implied warranties for the associated TI component or service and is an unfair and deceptive business practice. TI is not responsible or liable for any such statements.

Buyer acknowledges and agrees that it is solely responsible for compliance with all legal, regulatory and safety-related requirements concerning its products, and any use of TI components in its applications, notwithstanding any applications-related information or support that may be provided by TI. Buyer represents and agrees that it has all the necessary expertise to create and implement safeguards which anticipate dangerous consequences of failures, monitor failures and their consequences, lessen the likelihood of failures that might cause harm and take appropriate remedial actions. Buyer will fully indemnify TI and its representatives against any damages arising out of the use of any TI components in safety-critical applications.

In some cases, TI components may be promoted specifically to facilitate safety-related applications. With such components, TI's goal is to help enable customers to design and create their own end-product solutions that meet applicable functional safety standards and requirements. Nonetheless, such components are subject to these terms.

No TI components are authorized for use in FDA Class III (or similar life-critical medical equipment) unless authorized officers of the parties have executed a special agreement specifically governing such use.

Only those TI components which TI has specifically designated as military grade or "enhanced plastic" are designed and intended for use in military/aerospace applications or environments. Buyer acknowledges and agrees that any military or aerospace use of TI components which have **not** been so designated is solely at the Buyer's risk, and that Buyer is solely responsible for compliance with all legal and regulatory requirements in connection with such use.

TI has specifically designated certain components as meeting ISO/TS16949 requirements, mainly for automotive use. In any case of use of non-designated products, TI will not be responsible for any failure to meet ISO/TS16949.

### Products

Audio	<a href="http://www.ti.com/audio">www.ti.com/audio</a>
Amplifiers	<a href="http://amplifier.ti.com">amplifier.ti.com</a>
Data Converters	<a href="http://dataconverter.ti.com">dataconverter.ti.com</a>
DLP® Products	<a href="http://www.dlp.com">www.dlp.com</a>
DSP	<a href="http://dsp.ti.com">dsp.ti.com</a>
Clocks and Timers	<a href="http://www.ti.com/clocks">www.ti.com/clocks</a>
Interface	<a href="http://interface.ti.com">interface.ti.com</a>
Logic	<a href="http://logic.ti.com">logic.ti.com</a>
Power Mgmt	<a href="http://power.ti.com">power.ti.com</a>
Microcontrollers	<a href="http://microcontroller.ti.com">microcontroller.ti.com</a>
RFID	<a href="http://www.ti-rfid.com">www.ti-rfid.com</a>
OMAP Applications Processors	<a href="http://www.ti.com/omap">www.ti.com/omap</a>
Wireless Connectivity	<a href="http://www.ti.com/wirelessconnectivity">www.ti.com/wirelessconnectivity</a>

### Applications

Automotive and Transportation	<a href="http://www.ti.com/automotive">www.ti.com/automotive</a>
Communications and Telecom	<a href="http://www.ti.com/communications">www.ti.com/communications</a>
Computers and Peripherals	<a href="http://www.ti.com/computers">www.ti.com/computers</a>
Consumer Electronics	<a href="http://www.ti.com/consumer-apps">www.ti.com/consumer-apps</a>
Energy and Lighting	<a href="http://www.ti.com/energy">www.ti.com/energy</a>
Industrial	<a href="http://www.ti.com/industrial">www.ti.com/industrial</a>
Medical	<a href="http://www.ti.com/medical">www.ti.com/medical</a>
Security	<a href="http://www.ti.com/security">www.ti.com/security</a>
Space, Avionics and Defense	<a href="http://www.ti.com/space-avionics-defense">www.ti.com/space-avionics-defense</a>
Video and Imaging	<a href="http://www.ti.com/video">www.ti.com/video</a>

### TI E2E Community

[e2e.ti.com](http://e2e.ti.com)