



厦门华联电子股份有限公司

Xiamen Hualian Electronics Corp., Ltd.

---

# 产品规格书

## SPECIFICATION

---

产品名称：光敏晶体管输出型光耦合器

DESCRIPTION: Photo-transistor Output Opto-coupler

产品型号：HPC214×h

PART NO.: HPC214×h

拟制 Prepared	审核 Verified	批准 Approved

电话 Tel: 86-0592-2950777

传真 Fax: 86-0592-6037471

网址 Web: [www.xmhl.com](http://www.xmhl.com)

地址：厦门市翔安区舂阳南路 189 号

Add: No.189, Fangyang South Road, Xiangan District, Xiamen China

## 1 概述 General

HPC214×h 是光敏晶体管输出型光耦合器，将红外 LED 芯片和光敏晶体管芯片封装在一起，以实现电—光—电转换。

The HPC214×h is Photo-transistor Output Opto-coupler, that infrared LED chips and Photo-transistor chip are assembled in the 1.27SOP4 package, in order to transfer signals by electricity-light-electricity.



图 1 产品 Figure 1-Product

## 2 特点 Features

- 光敏晶体管输出 Phototransistor output
- 输入、输出端之间绝缘电压高  
Isolation voltage between input and output  $V_{ISO} \geq 3750V_{rms}$
- 贴片式 4L 塑料封装 1.27SOP 4L Plastic Package
- 符合 RoHS 指令最新要求及 REACH 法规最新要求。Compliance with the latest requirements of the RoHS Directive and the latest REACH requirements.

## 3 应用 Applications

- 数字逻辑的传输及变换 Transmission and conversion of digital logic;
- 电源控制及开关 Power control and switch ;
- 电路与电路之间、系统与系统之间的电气绝缘隔离与阻抗变换 Electric insulation and impedance conversion between circuits systems.

## 4 极限参数 Absolute Maximum Ratings

表 1 极限参数

Table 1-Absolute Maximum Ratings

$T_a = (25 \pm 5)^\circ\text{C}$ , RH=30~75%

参数名称 Characteristic		符号 Symbol	额定值 Rating	单位 Unit
输入端 Input	正向电流 Forward Current	$I_F$	50	mA
	正向脉冲电流 Forward Current (Pulsed ) Pulse width $\leq 100 \mu s$ , frequency 100 Hz	$I_{FP}$	1	A
	耗散功率 Power Dissipation	$P_D$	100	mW
	节温 Junction Temperature	$T_J$	135	$^\circ\text{C}$
输出端 Output	集电极-发射极击穿电压 Collector- Emitter Breakdown Voltage	$V_{(BR)CEO}$	80	V
	发射极-集电极击穿电压 Emitter -Collector Breakdown Voltage	$V_{(BR)ECO}$	7	V
	集电极直流电流 Collector Current	$I_C$	50	mA
	集电极耗散功率 Collector Power Dissipation	$P_C$	150	mW
	节温 Junction Temperature	$T_J$	135	$^\circ\text{C}$

工作温度 Operating Temperature Range	T <sub>OPR</sub>	-55~125	°C
贮存温度 Storage Temperature Range	T <sub>STG</sub>	-55~125	°C
回流焊接温度 Reflow Soldering (10 seconds)	T <sub>h</sub>	260	°C
总耗散功率 Total Power Dissipation	P <sub>T</sub>	200	mW
输入-输出间绝缘电压 <sup>a</sup> Isolation voltage between input and output (AC, 60 Seconds, RH<60%)	V <sub>ISO</sub>	3750	V <sub>rms</sub>

<sup>a</sup> AC For 60 Seconds, R.H. = 40 ~ 60% Isolation voltage shall be measured using the following method. (1) Short between anode and cathode on the primary side and between collector and emitter on the secondary side. (2) The isolation voltage tester with zero-cross circuit shall be used. (3) The waveform of applied voltage shall be a sine wave.

## 5 电参数 Electrical Parameters

表 2 光电参数

Table 2-Opto-Electrical Characteristics Ta=(25±5)°C, RH=30~75%

参数名称 Characteristic		符号 Symbol	测试条件 Test Conditions	最小值 Min.	典型值 Typ.	最大值 Max.	单位 Unit
输入端 Input	正向电压 Forward Voltage	V <sub>F</sub>	I <sub>F</sub> =±10mA	1.1	1.3	1.45	V
输出端 Output	集电极-发射极击穿电压 Collector-Emitter Breakdown Voltage	V <sub>(BR)CEO</sub>	I <sub>C</sub> =0.1mA	80			V
	发射极-集电极击穿电压 Emitter-Collector Breakdown Voltage	V <sub>(BR)ECO</sub>	I <sub>E</sub> =0.1mA	7			V
	集电极-发射极泄露电流 Collector- Emitter Leakage Current	I <sub>CEO</sub>	V <sub>CE</sub> =20V			100	nA
传输隔离特性 Transfer Isolation Features	直流电流传输比 Current Transfer Ratio	CTR	具体见表 3 See table 3				%
	饱和压降 Saturation voltage	V <sub>CE(sat)</sub>	I <sub>F</sub> =±20mA I <sub>C</sub> =2mA			0.4	V
	输入-输出间隔电容 Isolation Capacitance between Input and Output	C <sub>ISO</sub>	V=0V F=1MHz		0.8		pF
	输入-输出间绝缘电阻 Isolation Resistance between Input and Output	R <sub>ISO</sub>	V=500V	10 <sup>12</sup>	10 <sup>14</sup>		Ω
	输入-输出间绝缘电压 Isolation Voltage between Input and Output	V <sub>ISO</sub>	I <sub>off</sub> <0.3mA, AC, 60 S	3750			V <sub>rms</sub>
	脉冲上升时间 Rise Time	t <sub>r</sub>	V <sub>CC</sub> =10V R <sub>L</sub> =100Ω		4	18	μs
	脉冲下降时间 Fall Time	t <sub>f</sub>	I <sub>C</sub> =2mA		7	18	μs
开启时间 Turn-on Time	t <sub>on</sub>	V <sub>CC</sub> =5V		5		μs	

	存储时间 Storage Time	$t_s$	$I_F = \pm 16\text{mA}$ $R_L = 1.9\text{k}\Omega^a$	20	$\mu\text{s}$
	关断时间 Turn-on Time	$t_{\text{off}}$			

a.  $t_{\text{on}}, t_s, t_{\text{off}}$  测试电路见图 2。 Figure 2. is the test circuit of  $t_{\text{on}}, t_s, t_{\text{off}}$ .

\*CTR 代码: HPC214×h, “×” 为 CTR 代码, 具体见下表:

\*CTR code: HPC214×h, the “×” was CTR code as below:

表 3 CTR 分档表 Table 3-Binning table of CTR

代码Code	测试条件Test Condition	最小值Min.	最大值Max.
P	$I_F = \pm 0.5\text{mA}, V_{CE} = 5\text{V}$	200	400
P <sub>1</sub>	$I_F = \pm 0.5\text{mA}, V_{CE} = 5\text{V}$	150	300
P <sub>2</sub>	$I_F = \pm 0.5\text{mA}, V_{CE} = 5\text{V}$	200	600
	$I_F = \pm 5\text{mA}, V_{CE} = 5\text{V}$	200	600
P <sub>3</sub>	$I_F = \pm 0.5\text{mA}, V_{CE} = 5\text{V}$	200	400
	$I_F = \pm 5\text{mA}, V_{CE} = 5\text{V}$	200	400
P <sub>4</sub>	$I_F = \pm 0.5\text{mA}, V_{CE} = 5\text{V}$	100	300
	$I_F = \pm 5\text{mA}, V_{CE} = 5\text{V}$	100	300



图 2  $t_{\text{on}}, t_s, t_{\text{off}}$  测试方法 Figure 2- The test method of  $t_{\text{on}}, t_s, t_{\text{off}}$

## 6 特性曲线 Performance Curves





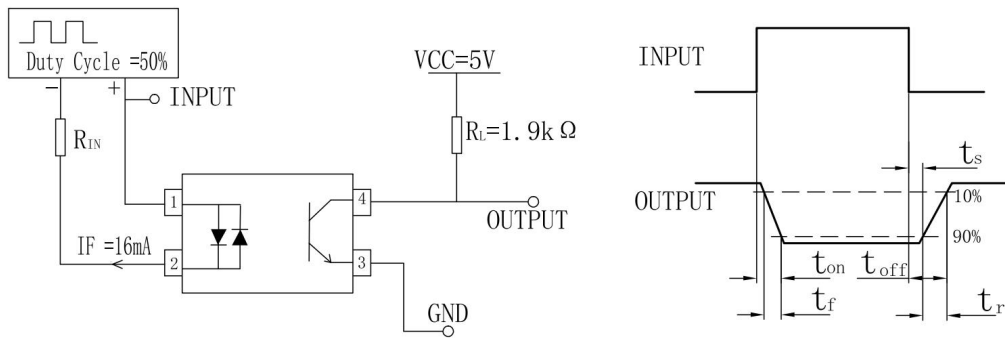
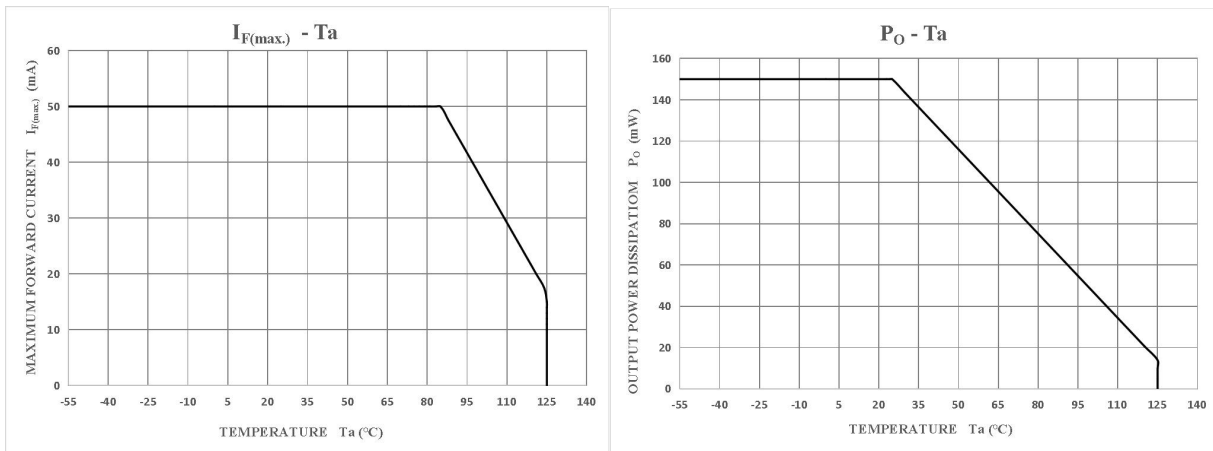
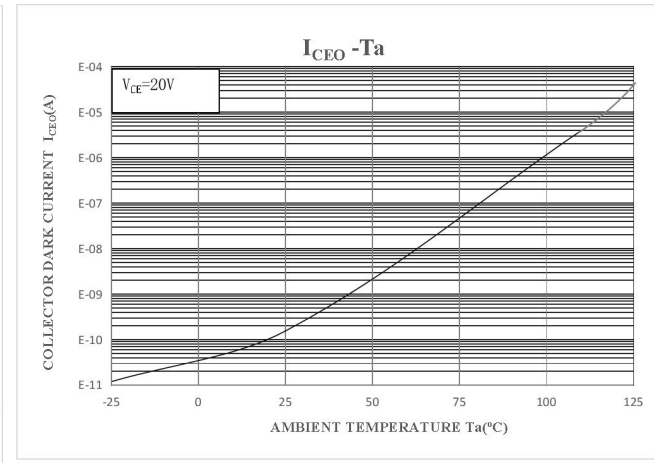
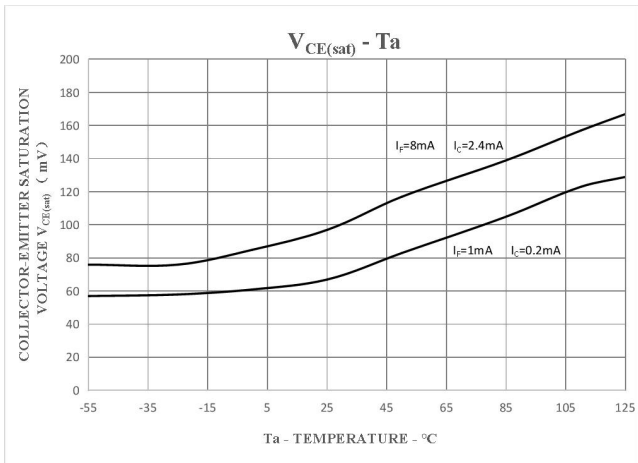
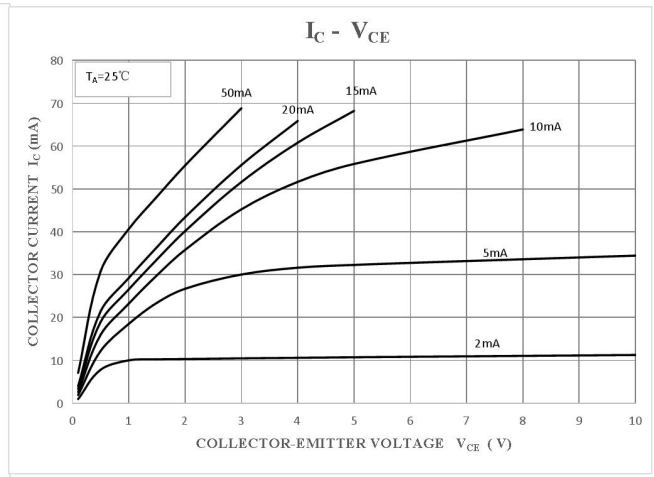
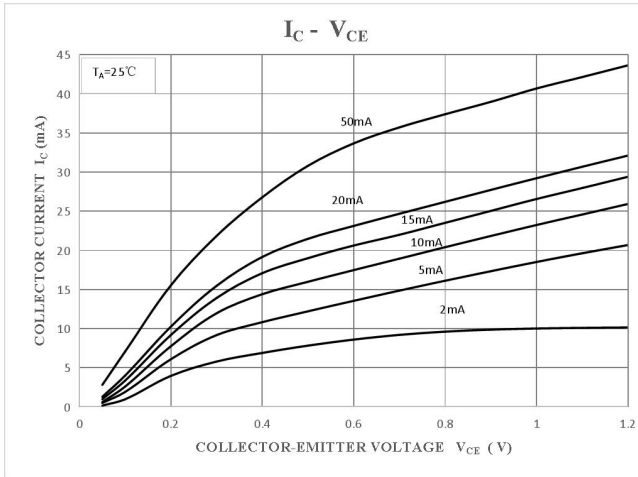
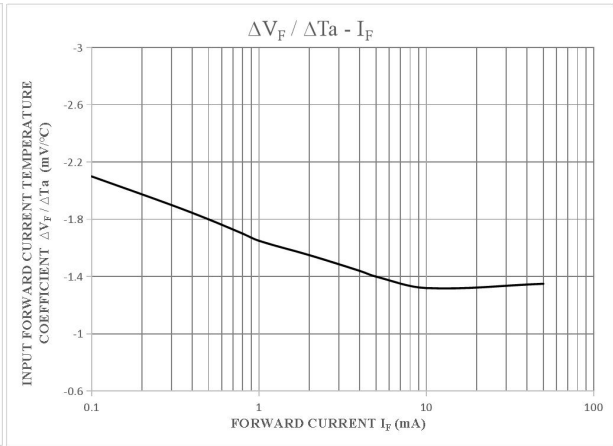
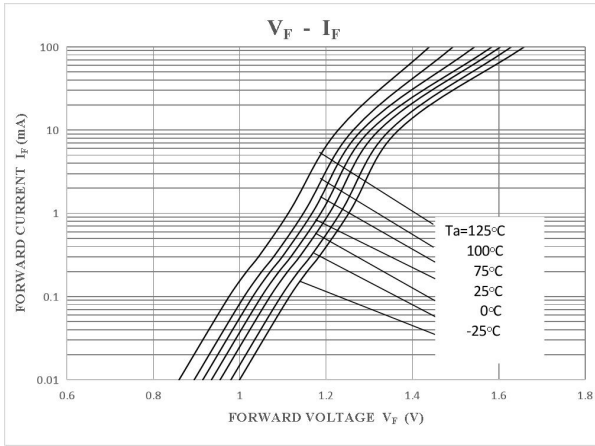
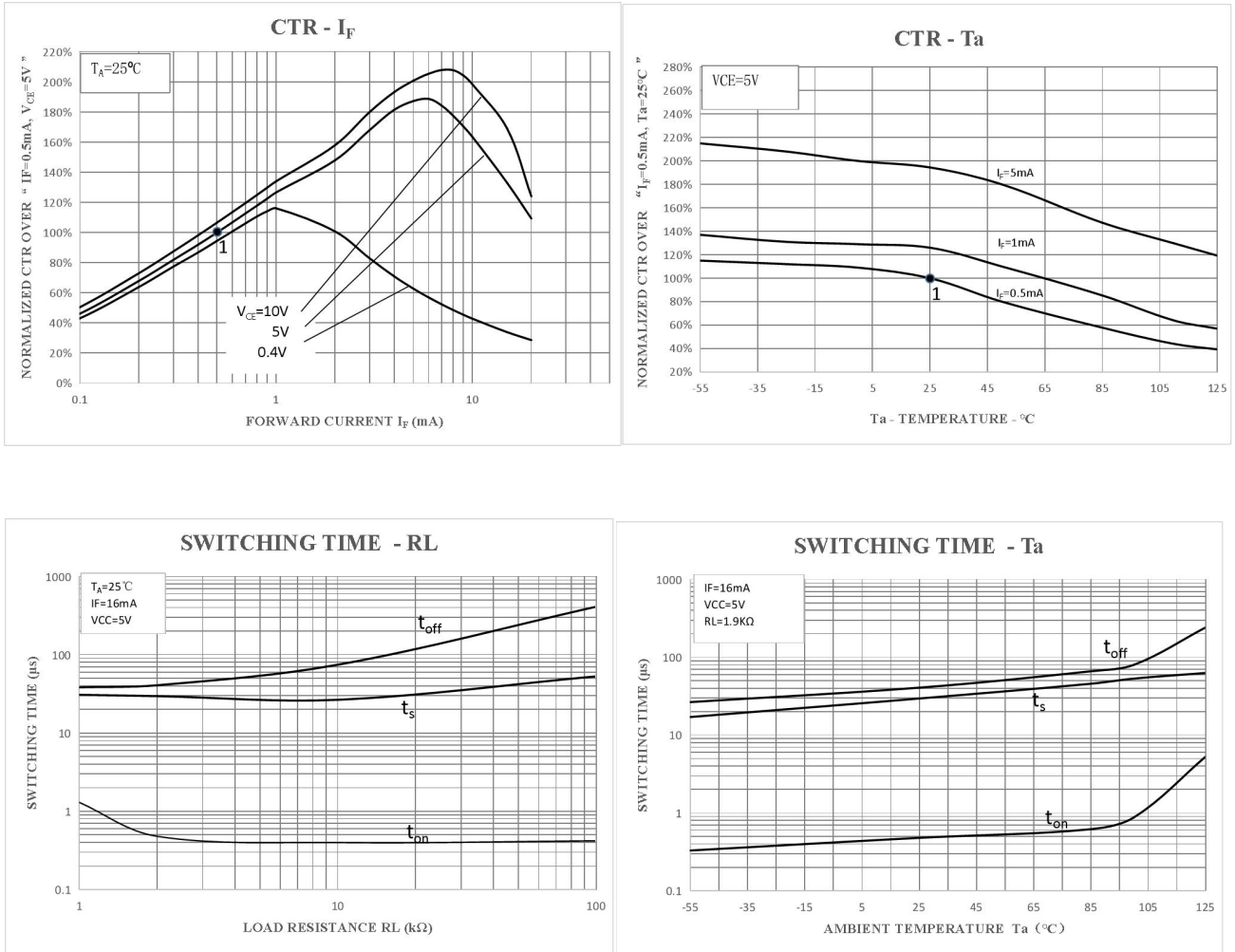

## 7 电原理图 Schematic Diagram



图 3 电原理图 Figure 3-Schematic

## 8 外形尺寸图 Dimensions Diagram

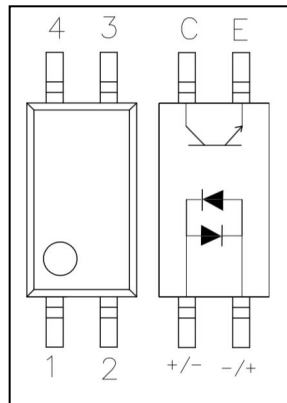

图 4 HPC214×h 外形尺寸  
Figure 4- The dimensions of HPC214×h

## 9 标志 Mark

产品上应有型号、公司商标、生产日期代码、引出端识别标记。例如：HPC214×h 产品印章如图 5。  
Print type characters, trade mark and Lot. No. on the Photo-transistor Coupler. For example the marking of product HPC214×h is shown as figure 5.

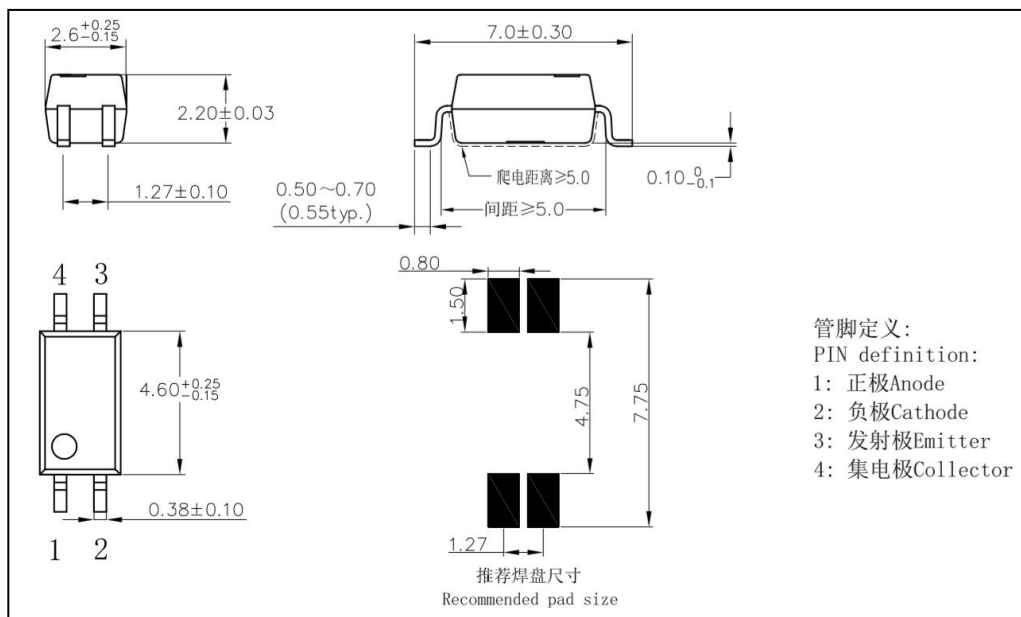

图 5 产品印章  
Figure 5- Marking

## 10 包装方式 Packing

10.1 编带包装 (Tape and reel) : 适用于 For HPC214×h。

10.1.1 每卷数量 (Qty/reel) : 3000 只 (pcs)。每箱数量 (Qty/ctn) : 45000 只 (pcs)。

10.1.2 内包装 (Inner packing) :

每卷盘 3000 只, 贴合格证 (型号、生产日期代号、检验员代号)。

3000pcs/reel, certificate on reel (model, code of product date, Inspector's code)

10.1.3 外包装(Outer packing):

公司名称、地址、商标、产品型号、数量等标志。

Indication of company name, address, trade mark, model and quantity.

10.1.4 示意图 (Schematic) (单位 Unit: mm) :



图 6 编带包装示意图

Figure 6- Taping Packing Schematic

## 10.2 标识 Label

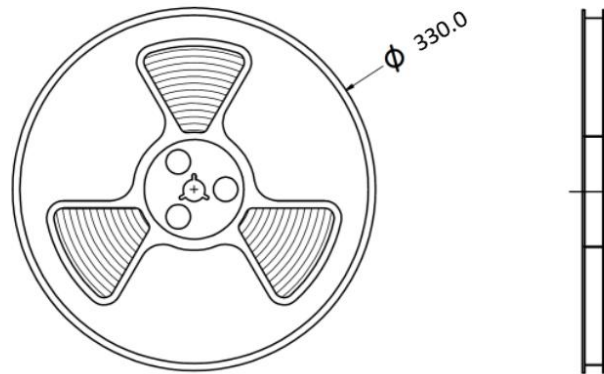
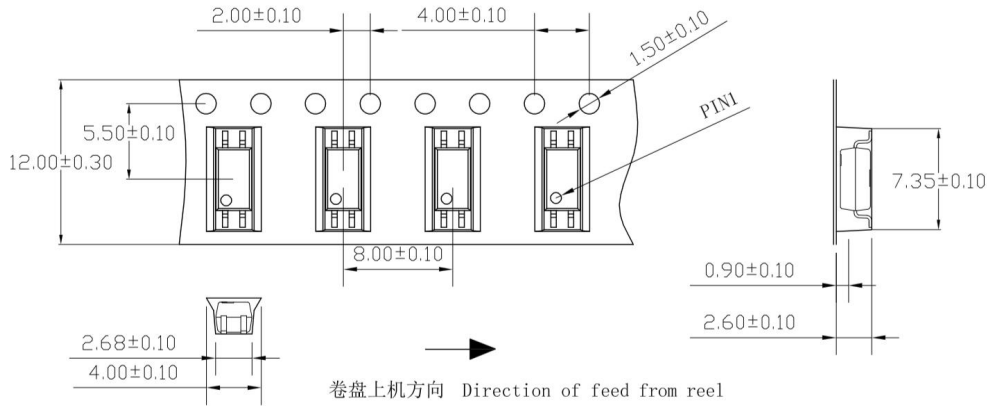

图 7 标识 Figure 7-Label

## 11 使用注意事项 Note

11.1 推荐贮存温度 Recommend storage Temp.: 0~40°C;

推荐贮存湿度 Recommend storage humidity: <60%;

贮存有效期一年 Storage life:One year.

湿气敏感度等级 1 级。MSL level: MSL 1.

11.2 静电防护等级（人体模式） ESD(HBM): ≥2kV.

11.3 引脚镀锡厚度：大于等于 5μm。

Thickness of Sn which plated on lead frame: ≥5μm.

11.4 推荐焊接条件 Recommended Soldering Conditions

11.4.1 请勿使用超过最高贮存温度的物体直接接触环氧本体。



Do not contact the epoxy body directly with objects exceeding the maximum storage temperature.

11.4.2 在高温下不要对环氧本体施加压力，特殊情况下施加的力不应超过2.5N。

Do not apply pressure to the epoxy at high temperatures, and in special cases do not apply more than 2.5N.

11.4.3 回流焊 Reflow soldering

1) 推荐锡膏规格 Recommend tin glue specifications:

a) 熔点 Melting temperature: 217°C

b) 组分 Contains: SnAg3Cu0.5

2) 回流焊工序必须在器件冷却至室温后进行。Never take next process until the component is cooled down to room temperature after reflow.

3) 推荐回流焊接参数，如下图所示： The recommended reflow soldering profile is following:

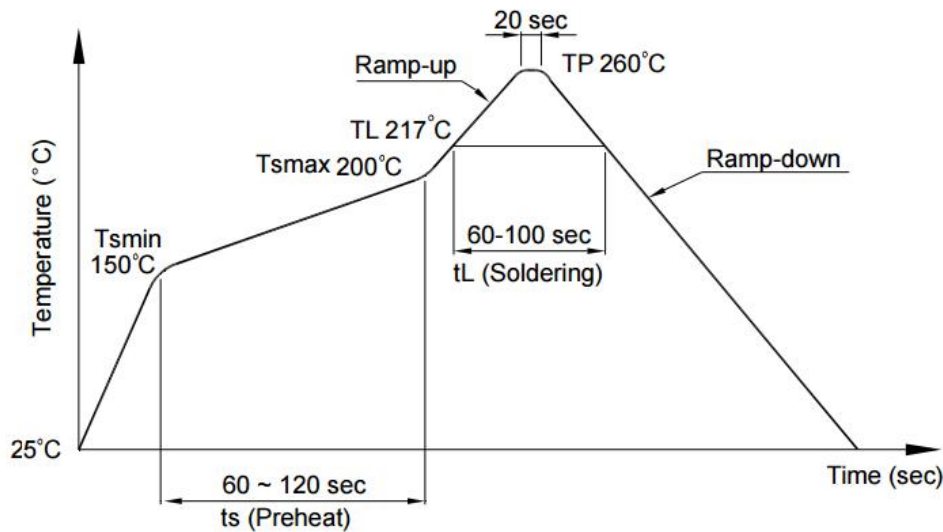

项目 Items		条件 Conditions
预热 Preheat	Temperature Min ( $T_{Smin}$ )	150°C
	Temperature Max ( $T_{Smax}$ )	200°C
	Time (min to max) ( $t_s$ )	90±30 sec
焊接区 Soldering zone	Temperature ( $T_L$ )	217°C
	Time ( $t_L$ )	60 ~100 sec
最高温度 Peak Temperature ( $T_P$ )		260°C
升温速率 Ramp-up rate		3°C / sec max.
降温速率 Ramp-down rate		3~6°C / sec

图 8 回流焊参数

Figure 8-Recommended reflow soldering profile

4) 建议在所示的温度和时间条件下进行一次回流焊，最多不能超过三次。One time soldering reflow is recommended within the condition of temperature and time profile shown below. Do not solder more than three times.

11.4.4 手工烙铁焊 Manual soldering

1) 手工烙铁焊仅用于产品返修或样品测试。Manual soldering is only applicable to product repair.

2) 手工烙铁焊要求：温度 $360^{\circ}\text{C} \pm 5^{\circ}\text{C}$ ，时间 $\leq 3\text{s}$ ，返修次数 $\leq 2$ 次。Manual soldering requirements: temperature  $\leq (360^{\circ}\text{C} \pm 5^{\circ}\text{C})$ , time  $\leq 3\text{s}$ , repair times  $\leq 2$  times.

11.5 本说明书所展示的产品是为一般电子应用而设计的，如办公自动化设备、通讯设备、视听设备、电气应用和仪器仪表等。对于需要高可靠性或安全性的设备，如空间应用、核动力控制设备、医疗设备等，请与我们的销售代表联系。The products shown in this publication are designed for the general use in electronic

applications such as office automation equipment, communications devices, audio/visual equipment, electrical application and instrumentation. For equipment/devices where high reliability or safety is required, such as space applications, nuclear power control equipment, medical equipment, etc, please contact our sales representatives.

## 12 产地 Production Place

**12.1 产地 Production Place:** 中国厦门 Xiamen China;

**12.2 工厂名称 Production NO.:** 厦门华联电子股份有限公司; Xiamen Hualian Electronics Corp. , Ltd.;

**12.3 工厂地址 Production Add.:** 中国厦门市翔安区舫阳南路 189 号 No.189, Fangyang South Road, Xiangan District, Xiamen China.