

# KA2142

## Vertical Deflection Output Circuit

### Features

- High output current
- Pump - up circuit
- Low dissipation
- Minimum number of external parts required
- Direct drive to the deflection coils
- Internal thermal shutdown circuit

### Applications

- Power Amplifier
- Thermal Protection
- Flyback Generator

### Description

The KA2142 is a monolithic linear IC designed for color TV and monitor vertical deflection output. It is intended for direct drive of the deflection coils with a high efficiency.



### internal Block Diagram

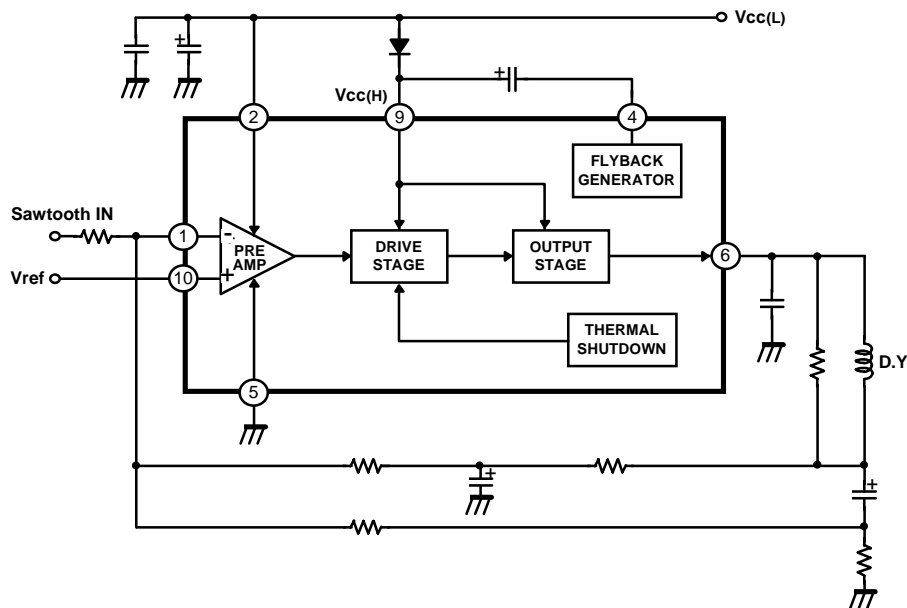

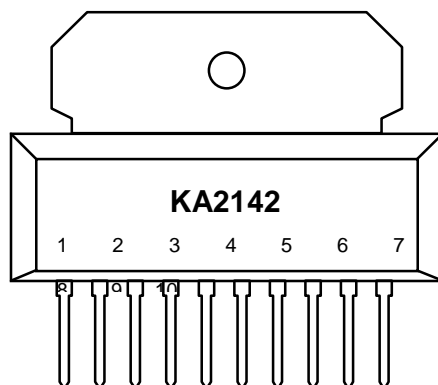

## Pin Assignments

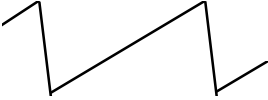
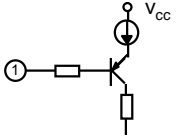

Pin Number	Pin Name	I/O	Pin Function Description
1	Vin ( - )	I	Inverting Input
2	Vcc(L)	I	Supply Voltage
3	-	-	N.C.
4	F.G	O	Flyback Generator
5	GND	-	Ground
6	VO	O	Output
7	-	-	N.C.
8	-	-	N.C.
9	Vcc(H)	I	Output Stage Supply Voltage
10	Vin ( + )	I	Non-Inverting Input

## PIN Definitions

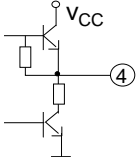
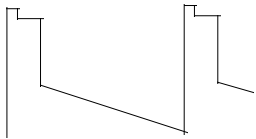
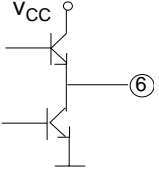
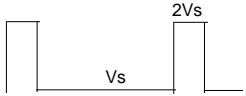
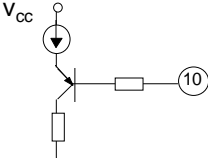
Pin Number	Pin Name	WAVEFORM	EQUIVALENT CIRCUIT
1	Inverting Input		
2	Voltage Supply	DC	-
4	Flyback Generator		
5	Ground	DC	-
6	Output Voltage		
9	Output Stage Voltage Supply		-
10	Non-Inverting Input	DC	

## Absolute Maximum Rating (Ta = 25°C)

Parameter	Symbol	Value	Unit
Supply Voltage	V <sub>cc(L)</sub>	35	V
Flyback Peak Voltage	V <sub>6</sub> , V <sub>9</sub>	70	V
Flyback Generator Voltage	V <sub>6</sub>	35	V
Input Voltage	V <sub>1</sub> , V <sub>10</sub>	V <sub>cc(L)</sub> - 0.5	V
Peak - to - Peak Output Current*	I <sub>o(p-p)</sub>	3	A
Peak - to - Peak Flyback Current ( f = 50 or 60Hz, T <sub>fb</sub> ≤ 1.5mS )	I <sub>4(p-p)</sub>	3	A
Total Power Dissipation ( Ta = 25°C )	P <sub>D</sub>	15	W
Storage Temperature Range	T <sub>stg</sub>	-40 ~ +150	°C
Operating Ambient Temperature	T <sub>opt</sub>	-25 ~ +70	°C

\* Maximum output peak to peak current in TV or Monitor set.

## Thermal Data

Parameter	Symbol	Value	Unit
Thermal Resistance Between Junction and Case	R <sub>th(j-c)</sub>	12	°C/W
Thermal Resistance Between Junction and Ambient	R <sub>th(j-a)</sub>	60	°C/W
Thermal Shut down Temperature	T <sub>tsd</sub>	150	°C

## Electrical Characteristic

(Refer to the test circuit , V<sub>cc(L)</sub>= 35V, unless otherwise specified)

Parameter	Symbol	Conditions	Min.	Typ.	Max.	Unit
Supply Voltage	V <sub>CC(L)</sub>	-	15	25	35	V
	V <sub>CC(H)</sub>	-	15	-	70	V
Supply Quiescent Current	I <sub>CC(L)</sub>	-	-	6	16	mA
	I <sub>CC(H)</sub>	-	-	22	36	mA
Pin4 Saturation Voltage to Gnd	V <sub>4SAT</sub>	I <sub>4</sub> = 20mA	-	0.5	1	V
Saturation Voltage to supply	V <sub>H SAT</sub>	I <sub>6</sub> = -1.2A	-	1.6	2.2	V
		I <sub>6</sub> = -0.7A	-	1.3	1.8	V
Saturation Voltage to ground	V <sub>L SAT</sub>	I <sub>6</sub> = 1.2A	-	1	1.4	V
		I <sub>6</sub> = 0.7A	-	0.7	1	V
Output Center Voltage	V <sub>MID</sub>	R <sub>1</sub> =5.6K, R <sub>fb</sub> =45K V <sub>1</sub> =V <sub>10</sub> =2V	-	18	-	V
Input Bias Current	I <sub>BIAS</sub>	V <sub>1</sub> = 1V, V <sub>10</sub> = 2V	-	-0.1	-1	μA

## Typical Performance Characteristic

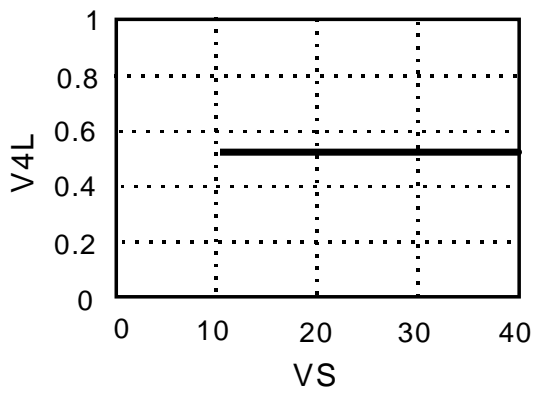

Figure 1. Vs-V4L

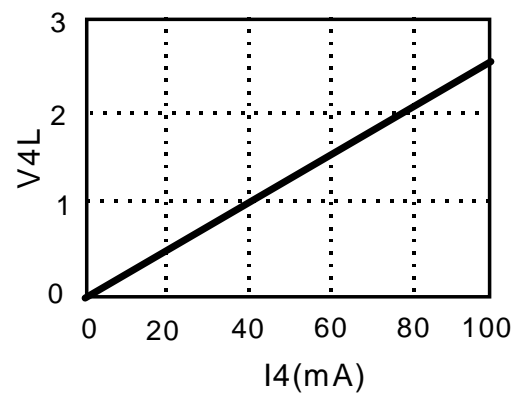

Figure 2. I4-V4L

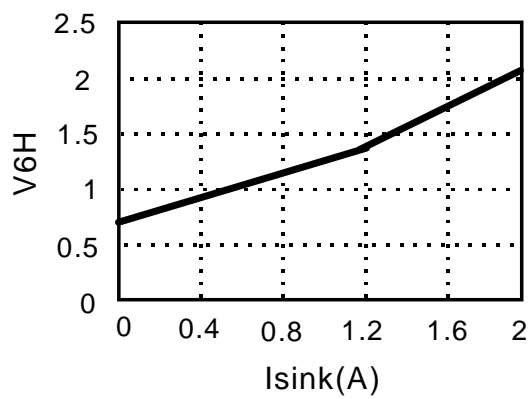

Figure 3. Isink-V6H

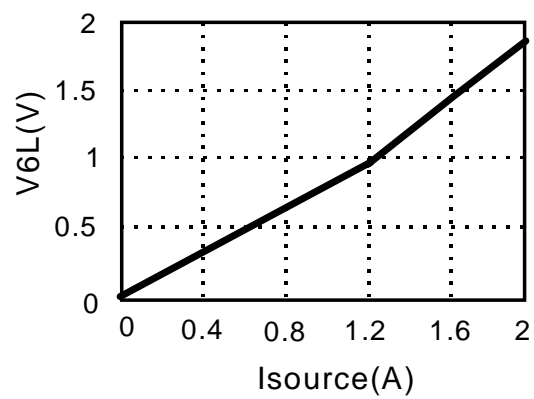

Figure 4. Isource-V6L

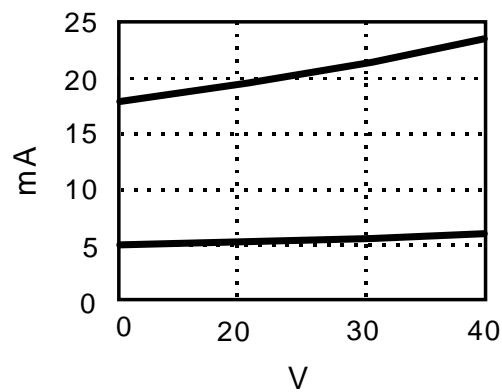
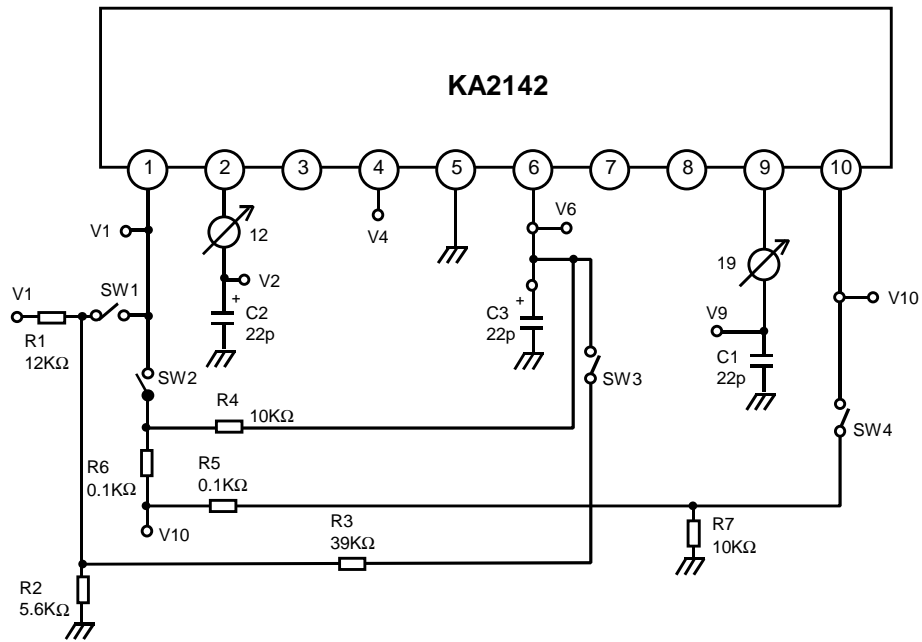

Figure 5. Vs-I2, I9

# DC Test Circuit



ITEM	INPUT VOLTAGE (V)					SWITCH STATE			
	V1	V10	Vin1	Vin2	SW1	SW2	SW3	SW4	
I2, I9	-	-	-	2	OFF	ON	OFF	ON	
I1	1	2	-	-	OFF	OFF	OFF	OFF	
V4L	3	2	-	-	OFF	OFF	OFF	OFF	
V6L	3	2	-	-	OFF	OFF	OFF	OFF	
V6H	1	2	-	-	OFF	OFF	OFF	OFF	



# Mechanical Dimensions

Package

Dimensions in millimeters

## 10-SIP H/S

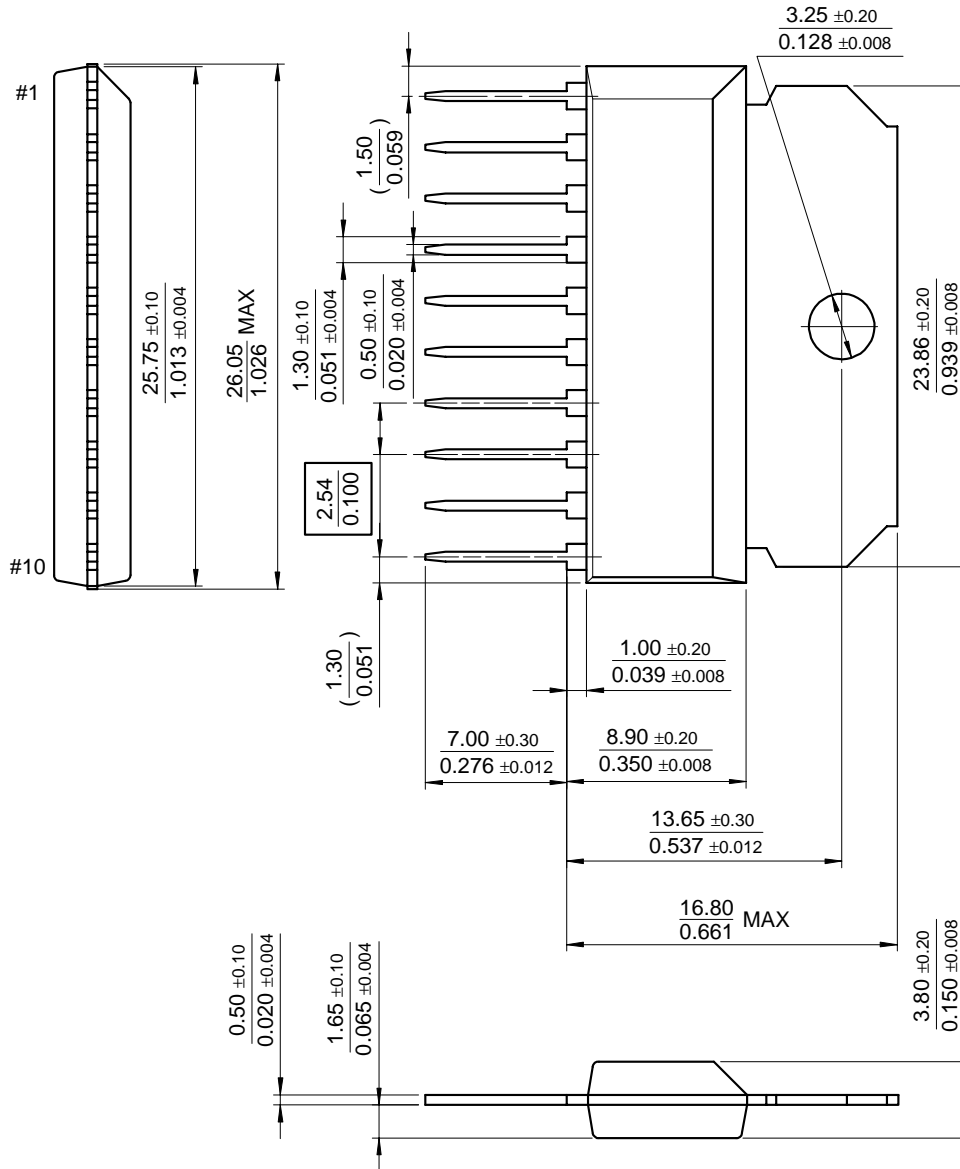



---

## Ordering Information

Product Number	Package	Operating Temperature
KA2142	10-SIP H/S	-20°C ~ +70 °C

**DISCLAIMER**

FAIRCHILD SEMICONDUCTOR RESERVES THE RIGHT TO MAKE CHANGES WITHOUT FURTHER NOTICE TO ANY PRODUCTS HEREIN TO IMPROVE RELIABILITY, FUNCTION OR DESIGN. FAIRCHILD DOES NOT ASSUME ANY LIABILITY ARISING OUT OF THE APPLICATION OR USE OF ANY PRODUCT OR CIRCUIT DESCRIBED HEREIN; NEITHER DOES IT CONVEY ANY LICENSE UNDER ITS PATENT RIGHTS, NOR THE RIGHTS OF OTHERS.

**LIFE SUPPORT POLICY**

FAIRCHILD'S PRODUCTS ARE NOT AUTHORIZED FOR USE AS CRITICAL COMPONENTS IN LIFE SUPPORT DEVICES OR SYSTEMS WITHOUT THE EXPRESS WRITTEN APPROVAL OF THE PRESIDENT OF FAIRCHILD SEMICONDUCTOR CORPORATION. As used herein:

1. Life support devices or systems are devices or systems which, (a) are intended for surgical implant into the body, or (b) support or sustain life, and (c) whose failure to perform when properly used in accordance with instructions for use provided in the labeling, can be reasonably expected to result in a significant injury of the user.
2. A critical component in any component of a life support device or system whose failure to perform can be reasonably expected to cause the failure of the life support device or system, or to affect its safety or effectiveness.