

Data sheet

Commercial Art.No.: 57.504.8155.0

Neutral disconnect terminal WKN 4ETK/U/V0

Neutral disconnect terminal with Screw connection for mounting on TS 35/ TS 32,
nominal cross section: 4 mm², width: 6 mm, color: blue

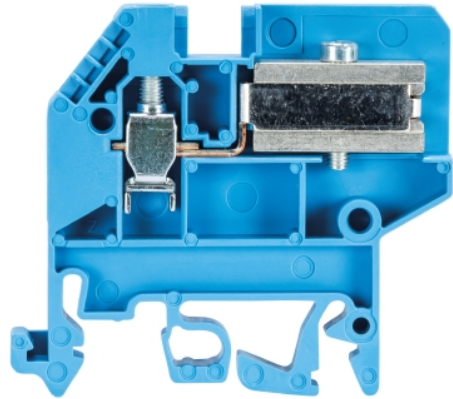

Commercial Art.No.	57.504.8155.0
EAN	4015573494435
Order Unit	100

Certificates / Approvals



Technical data

General

Nominal cross section	4 mm ²
Color	Blue
Width/grid dimension	6 mm
Inflammability class of insulation material acc. with UL94	V0
Mounting method	DIN rail (top hat rail)/G-rail
Terminal blocks for electrical installations	yes

Technical data

Rated current	25 A
Rated voltage	400 V
Rated impulse voltage	6 kV
Pollution degree	3
Connecting plate required	yes
Type of insulation material	Thermoplastic
Length	53.5 mm

Connection Data

Connection type 1	screw connection
Minimum cross section solid	0.5 mm ²
Maximum cross section solid	6 mm ²
Minimum cross section fine stranded	0.5 mm ²
Maximum cross section fine stranded	4 mm ²
Wire strip length	9 mm

Torque conductor mounting	0.5 Nm
For N-busbar	3x10 mm

Technical Data UL/CSA

Cross section CSA	20-10 AWG
Voltage CSA	600 V
Current CSA	25 A

Classification

ECLASS 11	
ECLASS 8.1	27141138
ETIM 7.0	EC001257
ETIM 6.0	EC001257
ETIM 5.0	EC001257
ETIM 4.0	EC001257
ETIM 3.0	EC001257



Product compliance

ROHS conformity status	Compliant/Exempted
ROHS exceptions	III-6(c)
REACH-SVHC conformity status	Duty-To-Declare
REACH-SVHC substances	Lead
REACH-SVHC CAS numbers	7439-92-1

Accessories

Commercial Art.No.:	Article-type description:	Description:
98.190.0000.0	Mounting rail TS 32 UNPERF - l:2000mm	Mounting rail G 32, unslotted, Höhe 5,5 mm, length 2 m, material steel. galv. zinc-plated and dichromated
98.190.1000.0	Mounting rail TS 32 PERF 15mm - l:2000mm	Mounting rail G 32, slotted, Höhe 15 mm, length 2 m, material steel. galv. zinc-plated and dichromated
98.210.0000.0	Mounting rail TS 32 UNPERF AL - l:2000mm	Mounting rail G 32, unslotted, Höhe 15 mm, length 2 m, material Aluminium
98.220.0000.0	Mounting rail TS 32 UNPERF CU - l:2000mm	Mounting rail G 32, unslotted, Höhe 15 mm, length 2 m, material E copper
98.300.0000.0	Mounting rail TS 35x7,5 UNPERF - l:2000mm	Mounting rail TS 35, unslotted, size 7,5 mm, length 2 m, material steel. galv. zinc-plated and dichromated
98.300.1000.0	Mounting rail TS 35x7,5 PERF 15mm - l:2000mm	Mounting rail TS 35, slotted, size 7,5 mm, length 2 m, material steel. galv. zinc-plated and dichromated
98.300.1900.0	Mounting rail TS 35x7,5 PERF 25mm - l:2000mm	Mounting rail TS 35, slotted, size 7,5 mm, length 2 m, material steel. galv. zinc-plated and dichromated
98.360.0000.0	Mounting rail TS 35x15-2,3 UNPERF - l:2000mm	Mounting rail TS 35, unslotted, size 15 mm, length 2 m, material steel. galv. zinc-plated and dichromated
98.360.0004.0	Mounting rail TS 35x15-2,3 UNPERF FZN - l:2000mm	Mounting rail TS 35, unslotted, size 15 mm, length 2 m, material steel, hot galvanized
98.370.0000.0	Mounting rail TS 35x15 UNPERF - l:2000mm	Mounting rail TS 35, unslotted, size 15 mm, length 2 m, material steel. galv. zinc-plated and dichromated
98.370.1000.0	Mounting rail TS 35x15 PERF 15mm - l:2000mm	Mounting rail TS 35, slotted, size 15 mm, length 2 m, material steel. galv. zinc-plated and dichromated
98.380.0000.0	Mounting rail TS 35x15-2,3 UNPERF CU - l:2000mm	Mounting rail TS 35, unslotted, size 15 mm, length 2 m, material E copper

07.312.1155.0	End plate APN 4ETK /V0	End plate for DIN rail terminal blocks type WKN 4 ETK..., color: grey
---------------	------------------------	---

-  Diese Maße werden bei Abnahme besonders geprüft
-  Ausschließlich Prüfmaße
-  Mit /E gekennzeichnete Maße sind nur für interne Zwecke gültig

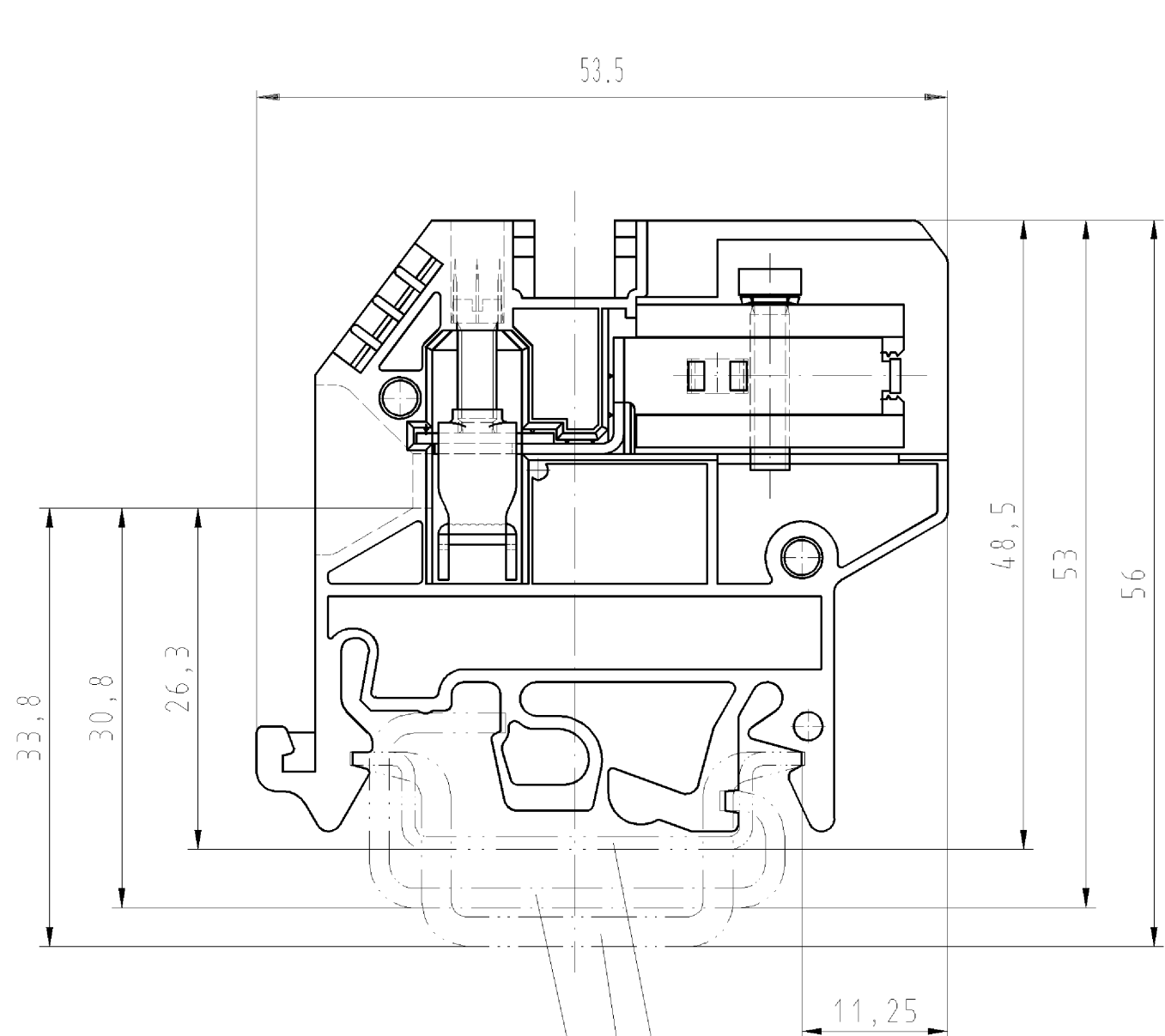

Hutschiene EN 60715-35x7,5
mounting rail EN 60715-35x7,5

Hutschiene EN 60715-35x15
mounting rail EN 60715-35x15

G-Schiene EN 60715-G32
G-rail EN 60715-G32

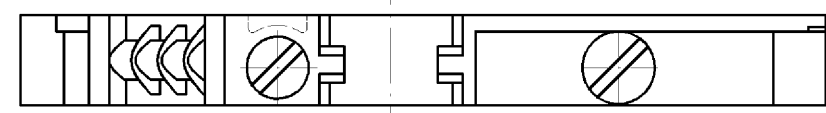

Weitere Daten siehe Katalog
further data see catalog

* Spezielle Verpackung
specific package

	Teile-Nummer Part-number	Farbe colour	Typ type
*	57.504.8155.0	blau/blue	WKN 4ETK/U /VO
*	57.504.8195.0	blau/blue	WKN 4ETK/U /VO

Freitoleranz nach DIN		CAD - Zeichnung, keine manuellen Änderungen			1. Verwendung: -		Bl.: 1 von 1	
	/	Maßstab	Werkstoff und Oberfläche:		2004	Tag	Name	
	/				Entworfen	14.10.	Schmitt J.	
	/	%			Geprüft	-	T	
	/				Normgepr.	-	Ersatz für: -	
	/	 wieland Elektrische Verbindungen		Benennung				
	/			NEUTRALLEITER_TRENNKLEMME Neutral disconnect terminal				
Buchstabe	Datum / Blatt	Änderung						

Weitergabe sowie Vervielfältigung dieses Dokuments, Verwertung und Mitteilung
 seines Inhalts sind verboten, soweit nicht ausdrücklich gestattet.
 The reproduction, distribution and utilization of this document as well as the
 communication of its contents to others without express authorization is prohibited.

575048155001K_4_CAD/028_Schmitt 2004-10-14T15:47:20 1.000