

Data sheet

Commercial Art.No.: 25.627.0353.0

PCB pin header 8813 S / 3 W OB

PCB pin header with pin header, connection method depends on used socket part , 3 poles, pitch: 3.81 mm, type of packing: carton, color: grey

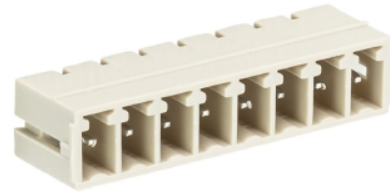

Commercial Art.No.	25.627.0353.0
EAN	4015573341654
Order Unit	100

Certificates / Approvals



Technical data

General

Modular spacing	3.81 mm
Soldering process	Wave soldering
Packaging	Carton
Number of poles	3
Number of levels	1
Marking	No
Fastening	None
Mating direction towards (circuit) board	180°

Technical data

Rated current	8 A
Overvoltage Category I	690 V
Overvoltage Category II	250 V
Overvoltage Category III	125
Rated impulse voltage	2.5 kV

Technical Data UL/CSA

Voltage UL	300 V
Current field wiring	8 A
Current factory wiring	8 A
Voltage CSA	300 V
Current CSA	5 A

Other

Type of insulation material	Thermoplastic
Color	Grey
Height	7.15 mm

Length	21.82 mm
Depth	9.2 mm
Material contact base	CuZn
Material contact surface	Sn

Classification

ECLASS 11	
ECLASS 8.1	27440402
ETIM 7.0	EC002637
ETIM 6.0	EC002637
ETIM 5.0	EC002637
ETIM 4.0	EC002637

Product compliance

ROHS conformity status	Compliant
REACH-SVHC conformity status	Compliant

Fits with

Commercial Art.No.:	Article-type description:	Description:
25.620.3353.0	PCB connector 8813 B / 3 OB	PCB female connector with screw connection with rising cage clamp system, 3 poles, max. cross section: 1.5 mm ² , pitch: 3.81 mm, type of packing: carton, color: grey
25.620.0353.0	PCB connector 8813 B / 3	PCB female connector with screw connection with rising cage clamp system, 3 poles, printed version, max. cross section: 1.5 mm ² , pitch: 3.81 mm, type of packing: carton, color: grey
25.622.3353.0	PCB connector 8813 B / 3 VR OB	PCB female connector with screw connection with rising cage clamp system, 3 poles, max. cross section: 1.5 mm ² , pitch: 3.81 mm, type of packing: carton, color: grey
25.622.0353.0	PCB connector 8813 B / 3 VR	PCB female connector with screw connection with rising cage clamp system, 3 poles, printed version, max. cross section: 1.5 mm ² , pitch: 3.81 mm, type of packing: carton, color: grey
25.624.3353.0	PCB connector 8813 B / 3 VL OB	PCB female connector with screw connection with rising cage clamp system, 3 poles, max. cross section: 1.5 mm ² , pitch: 3.81 mm, type of packing: carton, color: grey
25.624.0353.0	PCB connector 8813 B / 3 VL	PCB female connector with screw connection with rising cage clamp system, 3 poles, printed version, max. cross section: 1.5 mm ² , pitch: 3.81 mm, type of packing: carton, color: grey

6-polige Ausführung gezeichnet 6 pole version drawn

These dimensions will be especially checked at delivery
Only inspection dimensions
With /E marked dimensions are only valid for internal use

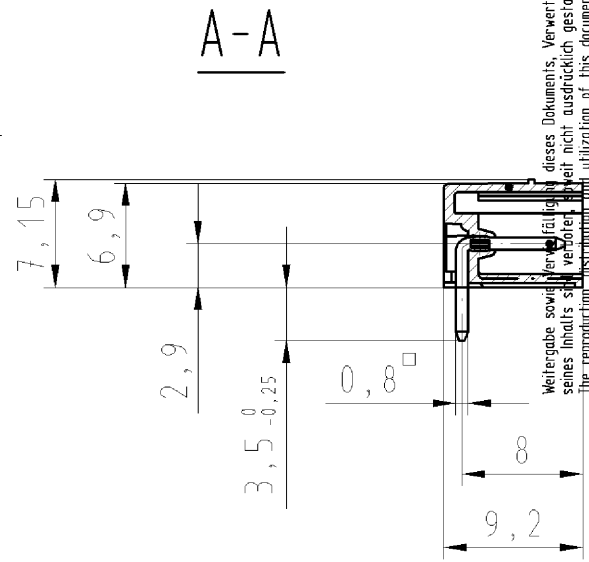
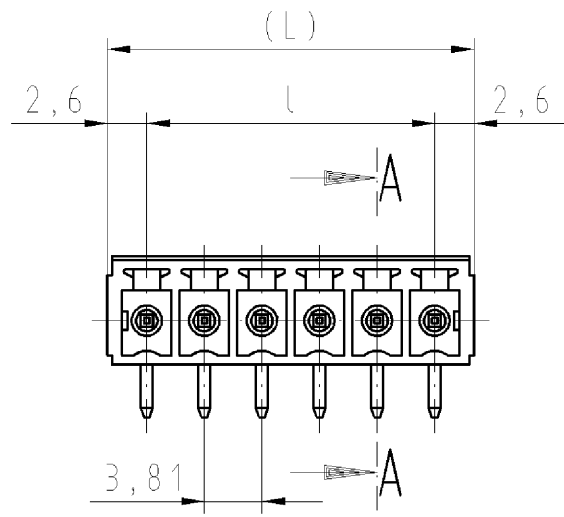
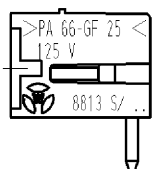

Weitergabe sowie Verfertigung dieses Dokuments, Verwertung und Mitteilung seines Inhalts sind verboten, soweit die Reproduktions- und Verwertungsrechte vorbehalten sind. The reproduction, distribution and utilization of this document as well as the communication of its contents to others without express authorization is prohibited.

Diese Maße werden bei Abnahme besonders geprüft
Ausschließlich Prüfmaße
Mit /E gekennzeichnete Maße sind nur für interne Zwecke gültig

Weitere Daten siehe Katalog
further data see catalog

.F	Farbe/colour
.0	grau/grey
.1	schwarz/black
.7	grün/green

Teile-Nr. part number	Pol- zahl	(L)	l	Typ type
25.627.0253.F	2	9.01	3.81	8813 S/ 2 W
25.627.0353.F	3	12.82	7.62	8813 S/ 3 W
25.627.0453.F	4	16.63	11.43	8813 S/ 4 W
25.627.0553.F	5	20.44	15.24	8813 S/ 5 W
25.627.0653.F	6	24.25	19.05	8813 S/ 6 W
25.627.0753.F	7	28.06	22.86	8813 S/ 7 W
25.627.0853.F	8	31.87	26.67	8813 S/ 8 W
25.627.0953.F	9	35.68	30.48	8813 S/ 9 W
25.627.1053.F	10	39.49	34.29	8813 S/10 W
25.627.1153.F	11	43.30	38.10	8813 S/11 W
25.627.1253.F	12	47.11	41.91	8813 S/12 W
25.627.1353.F	13	50.92	45.72	8813 S/13 W
25.627.1453.F	14	54.73	49.53	8813 S/14 W
25.627.1553.F	15	58.54	53.34	8813 S/15 W
25.627.1653.F	16	62.35	57.15	8813 S/16 W
25.627.1753.F	17	66.16	60.96	8813 S/17 W
25.627.1853.F	18	69.97	64.77	8813 S/18 W
25.627.1953.F	19	73.78	68.58	8813 S/19 W
25.627.2053.F	20	77.59	72.39	8813 S/20 W

Tolerierung nach DIN 7167/Tolerance system acc. to DIN 7167.
(This DIN-standard describes the envelope principle. According to the envelope principle the deviations of form and parallelism are limited by the size tolerances).

ja/yes Stoffverbots- und Deklarationsliste nach UU-TQM-05/03 ist einzuhalten.
Conformity with Wieland document UU-TQM-05/03 (list of prohibited / declarable hazardous substances) to be declared!

Freitoleranz nach
General tolerance

CAD - Zeichnung, keine manuellen Änderungen
CAD - drawing, no manual modifications allowed

1.Verwendung:
First Use:

Blatt: 1 von 1
Sheet: 1 of 1

Werkstoff/Material		2008	Tag/Date	Name	Zeichnung Nr./Drawing No.		Index
Maßstab/Scale 2:1		gezeichnet drawn	11.03.	Schmitt J.	T	25.627.0253.0 01K	
		geprüft checked	-	-			
		Normgepr. Stand. check	-	-			
Vol. mm ³ Of1./Surf. mm ²		Ersatz für/Replacement for: -					
 wieland Elektrische Verbindungen		Type	Benennung/Tittle				
		8813 S/ 2-20 W	LP_STIFTLISTE Rastermaß/pitch: 3,81mm PCB PIN HEADER				
Index	Datum / Blatt Date / Sheet						
Änderung/Revision							

256270253001K_4_CADW1042_Schmitt 2008-03-11T14:07:58 1.000