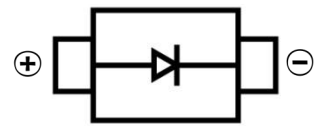

**SCHOTTKY BARRIER DIODE**
**FEATURES**

- Small Surface Mount device
- Low power loss, high efficiency
- High temperature soldering guaranteed:260°C/10 seconds at terminals
- Guard ring for over voltage protection
- For use in low voltage high frequency inverters, free wheeling, and polarity protection applications

**SMA**

**MECHANICAL DATA**

- Case: SMA(DO214AC)
- Case Material: Molded Plastic. UL flammability
- Classification Rating: 94V-0
- Weight: 0.065grams (approximate)

**MAXIMUM RATINGS (T<sub>A</sub> = 25°C unless otherwise noted)**

Parameter	Symbol	SS32A	SS33A	SS34A	SS36A	SS38A	SS310A	SS315A	SS320A	Unit
Marking		SS32	SS33	SS34	SS36	SS38	SS310	SS315	SS320	
Repetitive peak reverse voltage	V <sub>RRM</sub>	20	30	40	60	80	100	150	200	V
DC Reverse Voltage	V <sub>R</sub>	20	30	40	60	80	100	150	200	V
RMS Reverse Voltage	V <sub>RMS</sub>	14	21	28	42	56	70	105	140	V
Non-Repetitive Peak Forward Surge Current @ t = 8.3 ms	I <sub>FSM</sub>	80								A
Mean rectifying current	I <sub>F</sub>	3.0								A
Thermal Resistance	R <sub>θJA</sub>	85								°C/W
Junction Temperature	T <sub>J</sub>	150								°C
Storage Temperature	T <sub>STG</sub>	-55 ~+175								°C

**ELECTRICAL CHARACTERISTICS (T<sub>A</sub> = 25°C unless otherwise specified)**

Parameter	Symbol	SS32A	SS33A	SS34A	SS36A	SS38A	SS310A	SS315A	SS320A	Unit	Conditions
Forward voltage	V <sub>F</sub>	0.5			0.7	0.85		0.9	0.92	V	I <sub>F</sub> =3A
Reverse current T=25°C	I <sub>R</sub>	0.5								mA	V=V <sub>R</sub>
Reverse current T=100°C	I <sub>R</sub>	20								mA	
Junction capacitance	C <sub>J</sub>	160								pF	V=4V,f=1MHz

SCHOTTKY BARRIER DIODE

**Typical Characteristics**

FIG. 1 FORWARD CURRENT DERATING CURVE

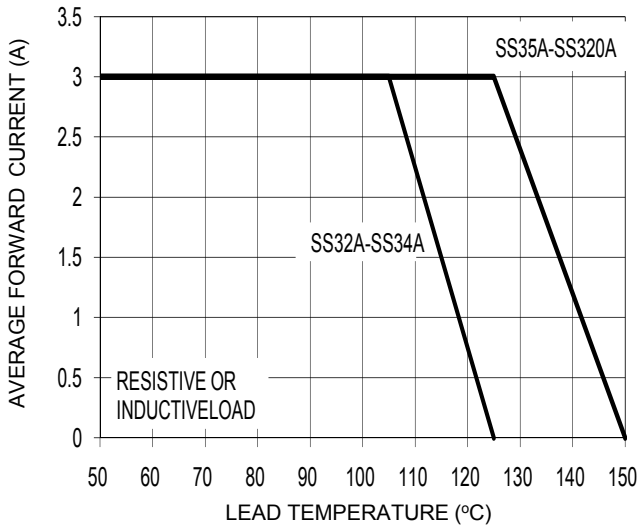

FIG. 2 MAXIMUM NON-REPETITIVE FORWARD SURGE CURRENT

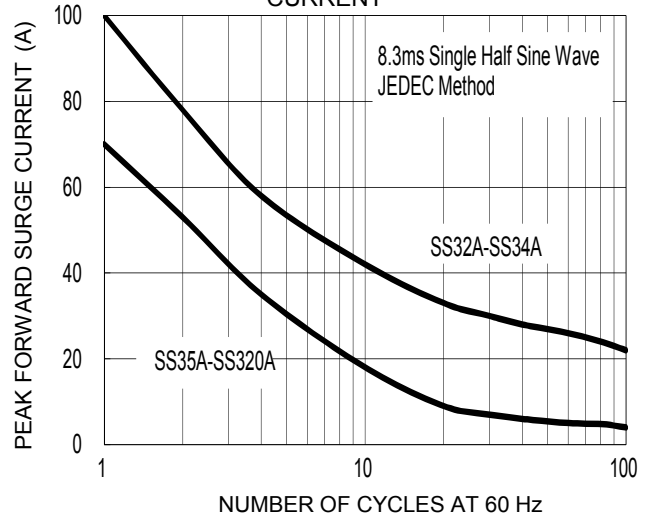

FIG. 3 TYPICAL FORWARD CHARACTERISTICS

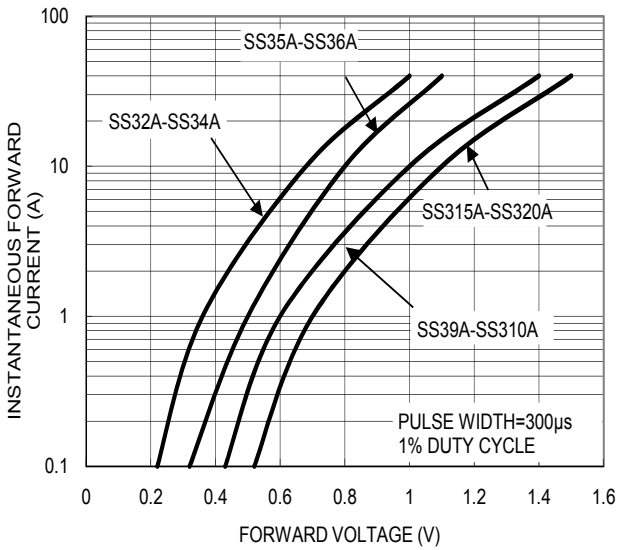

FIG. 4 TYPICAL REVERSE CHARACTERISTICS

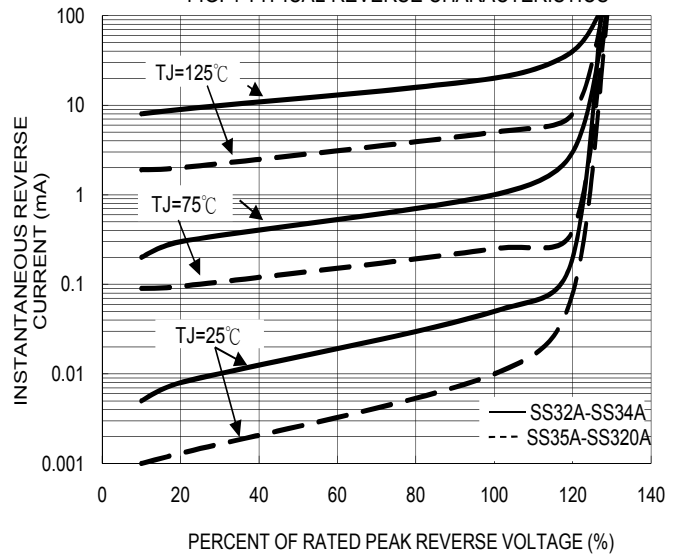

FIG. 5 TYPICAL JUNCTION CAPACITANCE

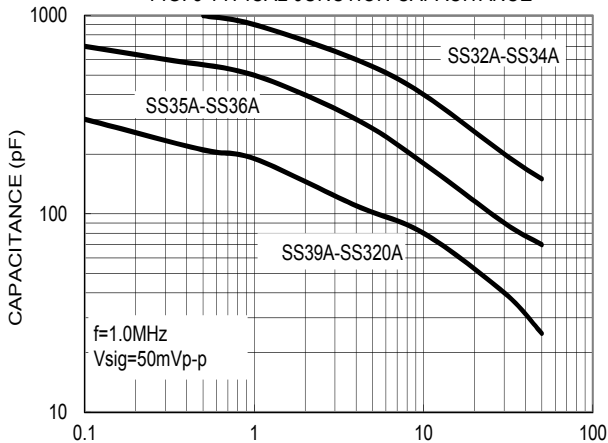
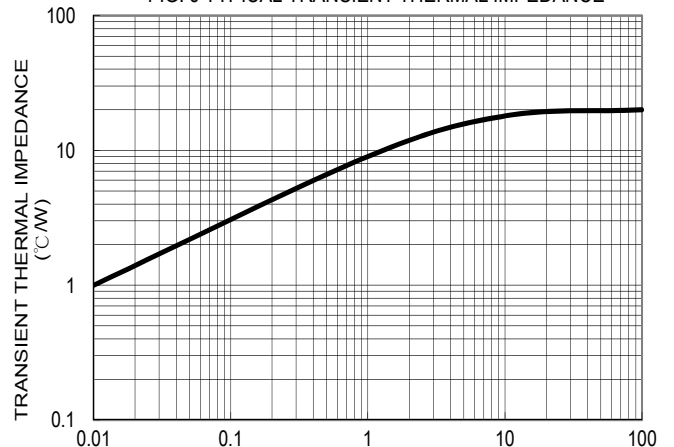
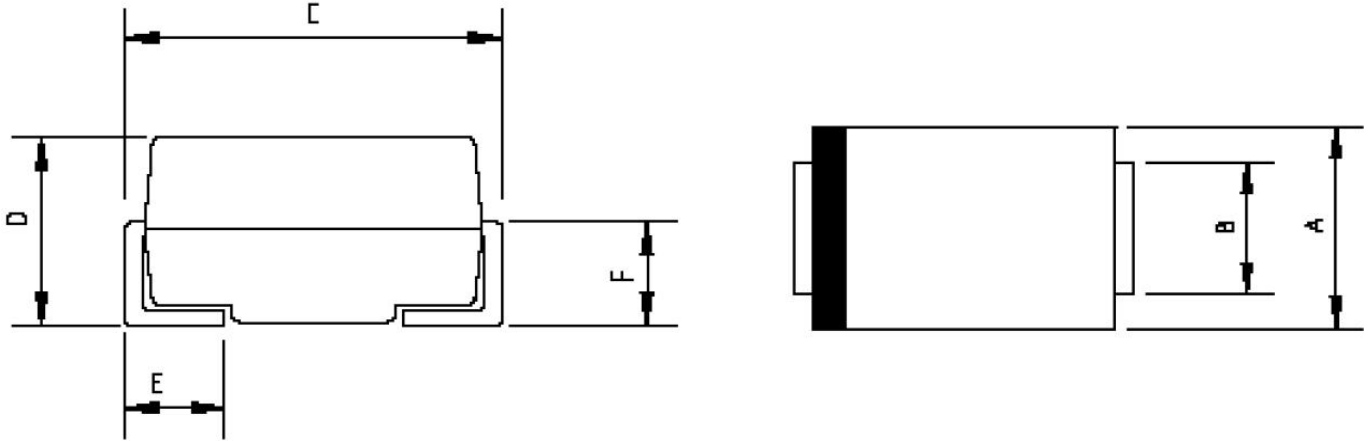

FIG. 6 TYPICAL TRANSIENT THERMAL IMPEDANCE



SCHOTTKY BARRIER DIODE

**SMA Package Outline Dimensions**



Symbol	Dimensions In Millimeters		Dimensions In Inches	
	Min.	Max.	Min.	Max.
A	2.20	2.80	0.086	0.110
B	1.30	1.70	0.051	0.067
C	4.70	5.30	0.185	0.209
D	1.70	2.55	0.067	0.100
E	0.90	1.50	0.035	0.059
F	0.90	1.50	0.035	0.059

**SMA Suggested Pad Layout**

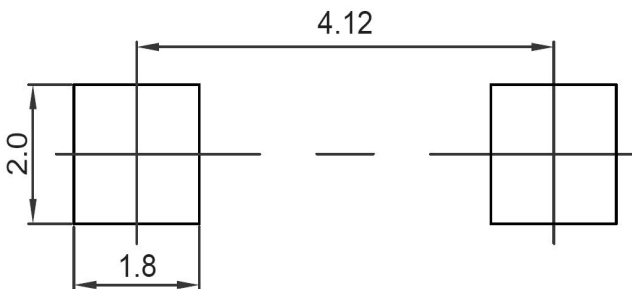

**Note:**

1. Controlling dimension: in millimeters
2. General tolerance:  $\pm 0.05\text{mm}$
3. The pad layout is for reference purposes only

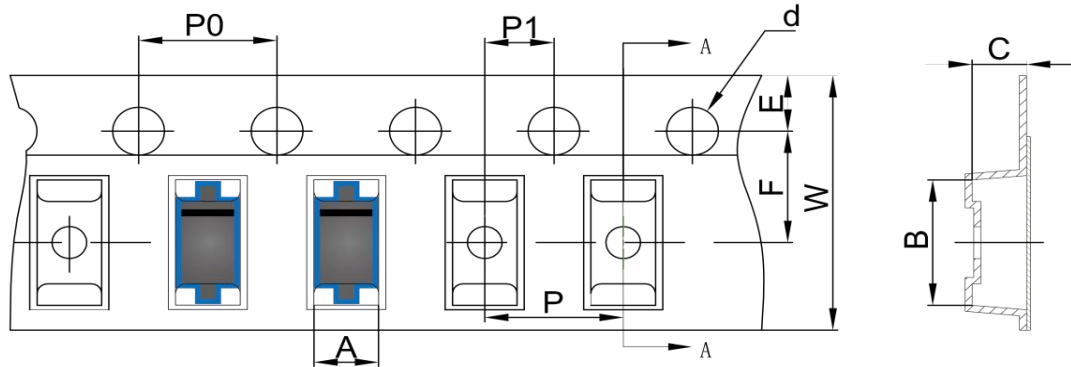
**SCHOTTKY BARRIER DIODE**
**SMA Tape and Reel**
**SMA Embossed Carrier Tape**

DIMENSIONS ARE IN MILLIMETER										
TYPE	A	B	C	d	E	F	P0	P	P1	W
SMA	2.89	5.35	2.68	Ø1.50	1.75	5.50	4.00	4.00	2.00	12.00
TOLERANCE	±0.1	±0.1	±0.1	±0.1	±0.1	±0.1	±0.1	±0.1	±0.1	±0.1

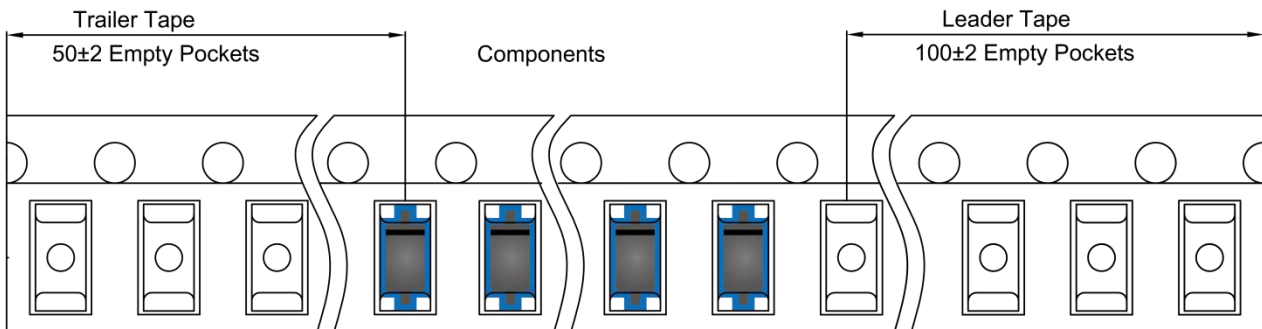
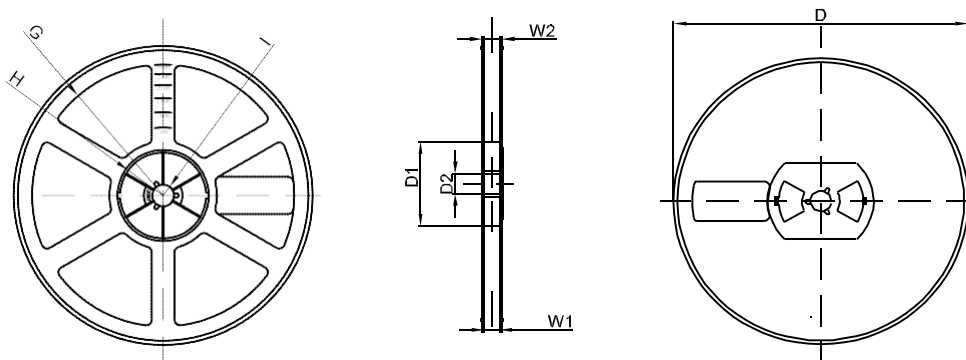
**SMA Tape Leader and Trailer**

**SMA Reel**

DIMENSIONS ARE IN MILLIMETER								
REEL OPTION	D	D1	D2	G	H	I	W1	W2
7" DIA	Ø178	54.40	13.00	R78	R25.60	R6.50	12.40	17.60
TOLERANCE	±2	±1	±1	±1	±1	±1	±1	±1