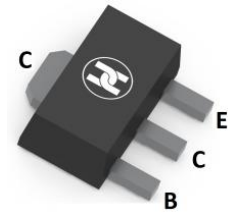
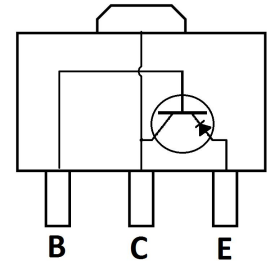

**BIPOLAR TRANSISTOR (PNP)**
**FEATURES**

- Complementary to BCX56
- High current and Low Voltage
- For Medium Power General Purpose
- For Drive Stages of Audio Amplifiers
- Surface Mount device

**SOT-89**

**MECHANICAL DATA**

- Case: SOT-89
- Case Material: Molded Plastic. UL flammability
- Classification Rating: 94V-0
- Weight: 0.055 grams (approximate)

**MAXIMUM RATINGS (T<sub>A</sub> = 25°C unless otherwise noted)**

Parameter	Symbol	Value	Unit
Collector-Base Voltage	V <sub>CB0</sub>	-100	V
Collector-Emitter Voltage	V <sub>CEO</sub>	-80	V
Emitter-Base Voltage	V <sub>EBO</sub>	-5	V
Collector Current	I <sub>C</sub>	-1	A
Collector Power Dissipation	P <sub>C</sub>	500	mW
Thermal Resistance From Junction To Ambient	R <sub>θJA</sub>	250	°C/W
Junction Temperature	T <sub>J</sub>	150	°C
Storage Temperature	T <sub>STG</sub>	-55 ~+150	°C

**ELECTRICAL CHARACTERISTICS (T<sub>A</sub> = 25°C unless otherwise specified)**

Parameter	Symbol	Min	Typ	Max	Unit	Conditions
Collector-base breakdown voltage	V <sub>(BR)CBO</sub>	-100			V	I <sub>C</sub> =-100μA, I <sub>E</sub> =0
Collector-emitter breakdown voltage	V <sub>(BR)CEO</sub>	-80			V	I <sub>C</sub> =-10mA, I <sub>B</sub> =0
Emitter-base breakdown voltage	V <sub>(BR)EBO</sub>	-5			V	I <sub>E</sub> =-100μA, I <sub>C</sub> =0
Collector cut-off current	I <sub>CB0</sub>			-0.1	μA	V <sub>CB</sub> =-30V, I <sub>E</sub> =0
Emitter cut-off current	I <sub>EBO</sub>			-0.1	μA	V <sub>EB</sub> =-5V, I <sub>C</sub> =0
DC current gain	h <sub>FE1</sub>	63				V <sub>CE</sub> =-2V, I <sub>C</sub> =-5mA
	h <sub>FE2</sub>	63		250		V <sub>CE</sub> =-2V, I <sub>C</sub> =-150mA
	h <sub>FE3</sub>	40				V <sub>CE</sub> =-2V, I <sub>C</sub> =-500mA
Collector-emitter saturation voltage	V <sub>CE(sat)</sub>			-0.5	V	I <sub>C</sub> =-500mA, I <sub>B</sub> =-50mA
Base-emitter voltage	V <sub>BE</sub>			-1	V	V <sub>CE</sub> =-2V, I <sub>C</sub> =-500mA
Transition frequency	f <sub>T</sub>		50		MHz	V <sub>CE</sub> =-5V, I <sub>C</sub> =-10mA, f=100MHz

**CLASSIFICATION OF h<sub>FE</sub>**

Rank	BCX53	BCX53-10	BCX53-16
Range	63-250	63-160	100-250
Marking	AH	AK	AL

**BIPOLAR TRANSISTOR (PNP)**

**Typical Characteristics**

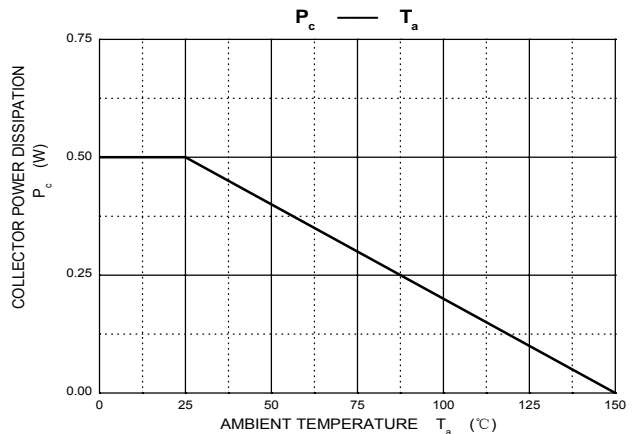
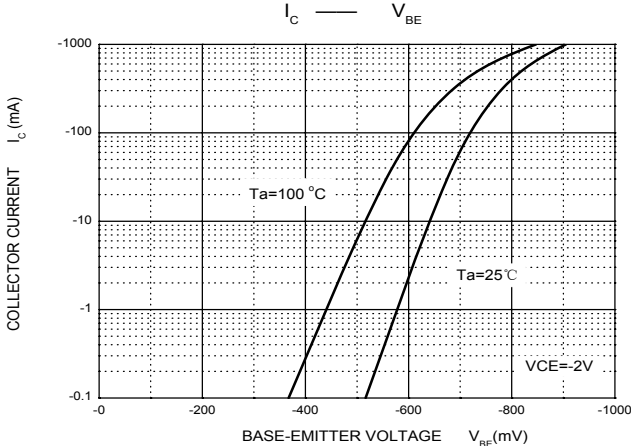
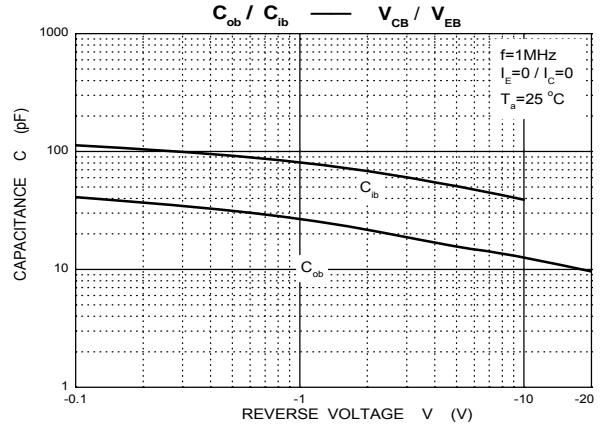
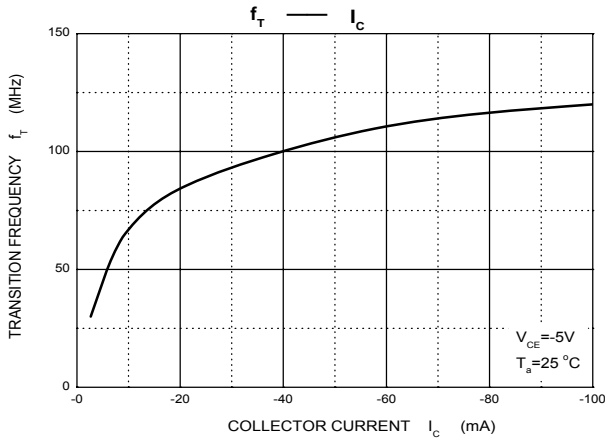
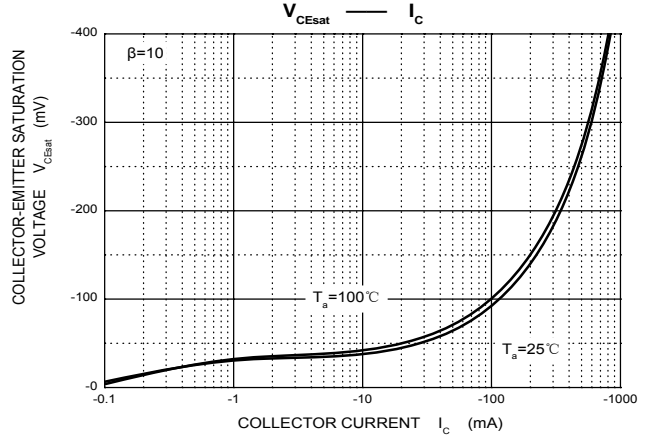
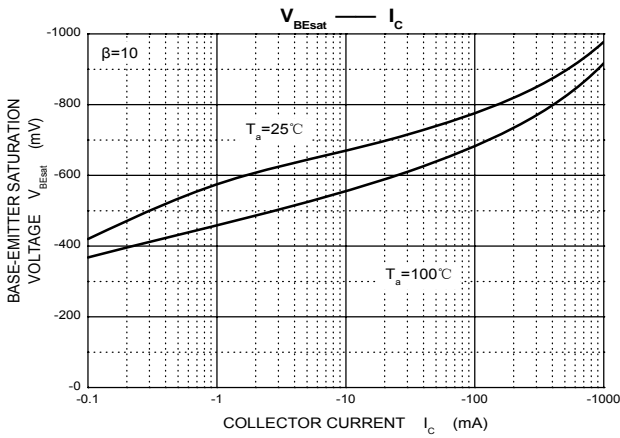
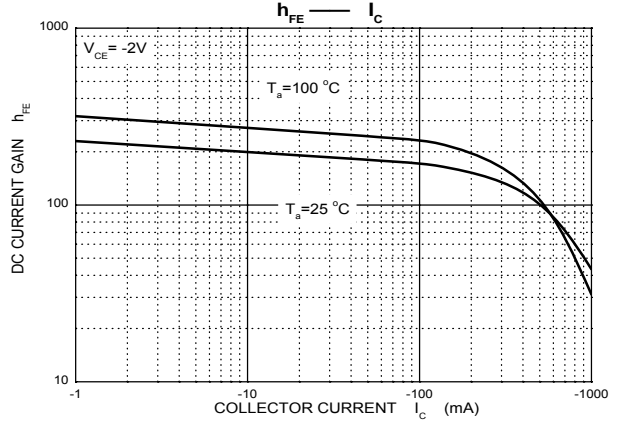
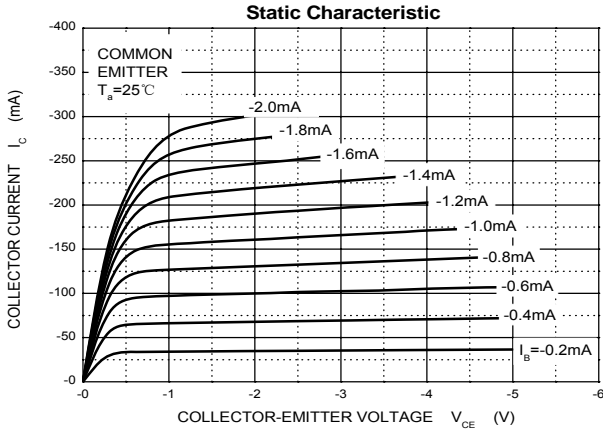

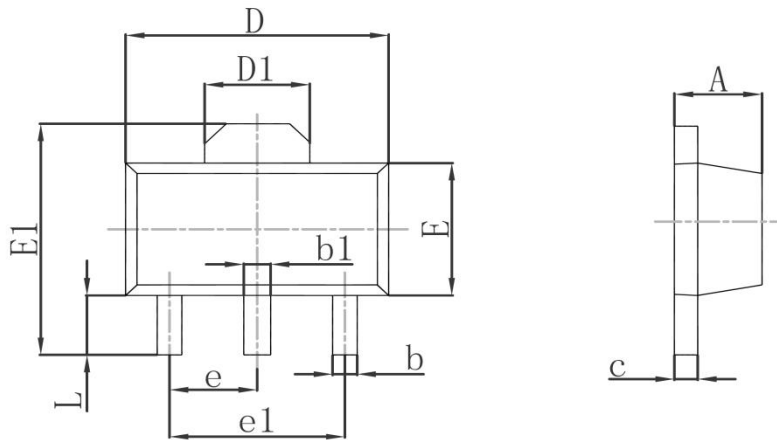
**BIPOLAR TRANSISTOR (PNP)**
**SOT-89 Package Outline Dimensions**

Symbol	Dimensions In Millimeters		Dimensions In Inches	
	Min.	Max.	Min.	Max.
A	1.400	1.600	0.055	0.063
b	0.320	0.520	0.013	0.020
b1	0.400	0.580	0.016	0.023
c	0.350	0.440	0.014	0.017
D	4.400	4.600	0.173	0.181
D1	1.550REF		0.061REF	
E	2.300	2.600	0.091	0.102
E1	3.940	4.250	0.155	0.167
e	1.500TYP		0.060TYP	
e1	3.000TYP		0.118TYP	
L	0.900	1.200	0.035	0.047

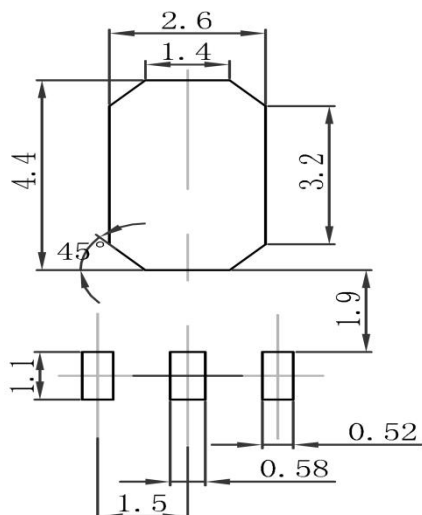
**SOT-89 Suggested Pad Layout**

**Note:**

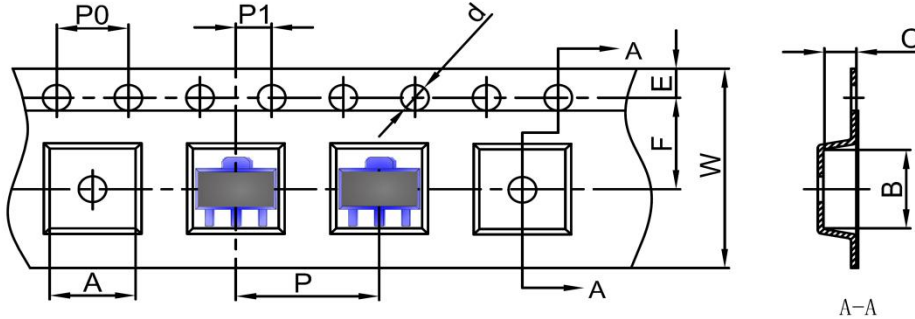
1. Controlling dimension: in millimeters
2. General tolerance:  $\pm 0.05\text{mm}$
3. The pad layout is for reference purposes only

**BIPOLAR TRANSISTOR (PNP)**
**SOT-89 Tape and Reel**
**SOT-89 Embossed Carrier Tape**

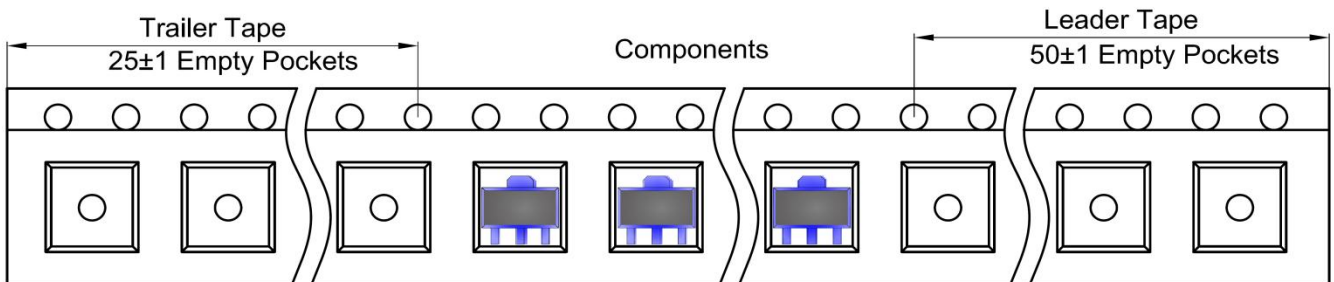
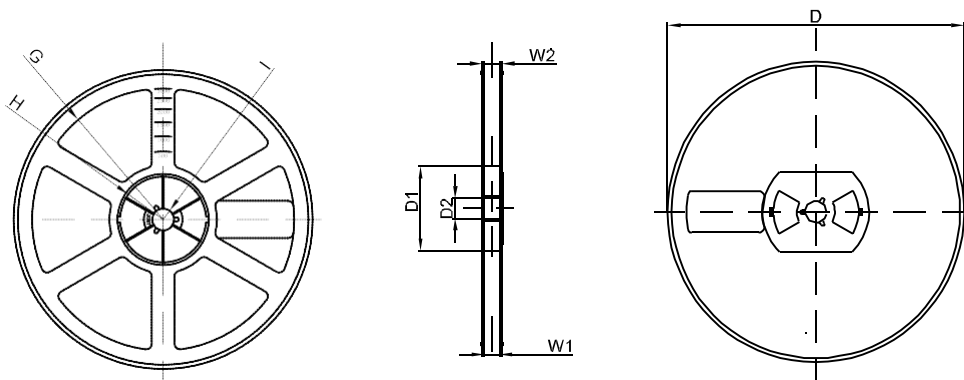
DIMENSIONS ARE IN MILLIMETER										
TYPE	A	B	C	d	E	F	P0	P	P1	W
SOT-89	4.85	4.45	1.85	Ø1.50	1.75	5.50	4.00	8.00	2.00	12.00
TOLERANCE	±0.1	±0.1	±0.1	±0.1	±0.1	±0.1	±0.1	±0.1	±0.1	±0.1

**SOT-89 Tape Leader and Trailer**

**SOT-89 Reel**

DIMENSIONS ARE IN MILLIMETER								
REEL OPTION	D	D1	D2	G	H	I	W1	W2
7" DIA	Ø178	54.40	13.00	R78	R25.60	R6.50	13.20	16.50
TOLERANCE	±2	±1	±1	±1	±1	±1	±1	±1