

深圳市维拓精电科技有限公司

WTL International Limited

APPROVAL SHEET

DESCRIPTION :	3.8*8mm 4 Pads SMD Tuning Fork Crystal			
NOMINAL FREQ.:	32.768KHz			
WTL P/N:	WTL3X85268FO			
VERSION:	1			
DATE:	2022.04.21			
Customer	Customer P/N			
Promelectronica	/			
Customer Signature	WTL			
	Approved by: <i>Kevin Liu</i>			
	Checked by: <i>Shu Ping</i>			
	Issued by: <i>Shengbiao</i>			
REVISION HISTORY				
Revised Page	Revision Content	Date	Ref. No.	Reviser



FEATURE

- Wide Frequency range
- Small size
- Tape & Reel
- Reflow available



APPLICATIONS

- Microprocessor Systems
- Consumer Electronics



ELECTRICAL SPECIFICATIONS

Frequency	32.768KHz
Frequency Tolerance (at 25°C)	±20ppm
ESR	50Kohm Max
Turnover Temperature	25±5°C
Frequency Temperature Curve	-0.034(±0.006)ppm/°C ²
Storage Temperature Range	-55°C~+125°C
Operable Temperature Range	-40°C~+85°C
Shunt Capacitance (C0)	2.0pF Typ
Dynamic Capacitance (C1)	4fF Typ
Driver Level (Typical)	1 μW Max
Load Capacitance(CL)	12.5 pF
Aging @25°C 1st year (Max)	±3ppm/year

REMARK: SPECIFICATIONS SUBJECT TO CHANGE WITHOUT PRIOR NOTICE. PLEASE CONFIRM WITH OUR SALES ENGINEER.

FREQUENCY VS TEMPERATURE CURVE

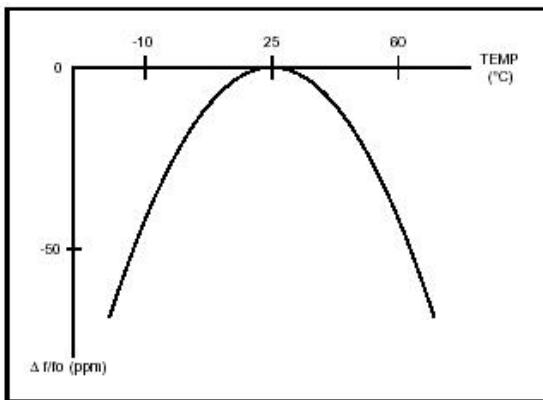

DIMENSIONS (Unit: mm)

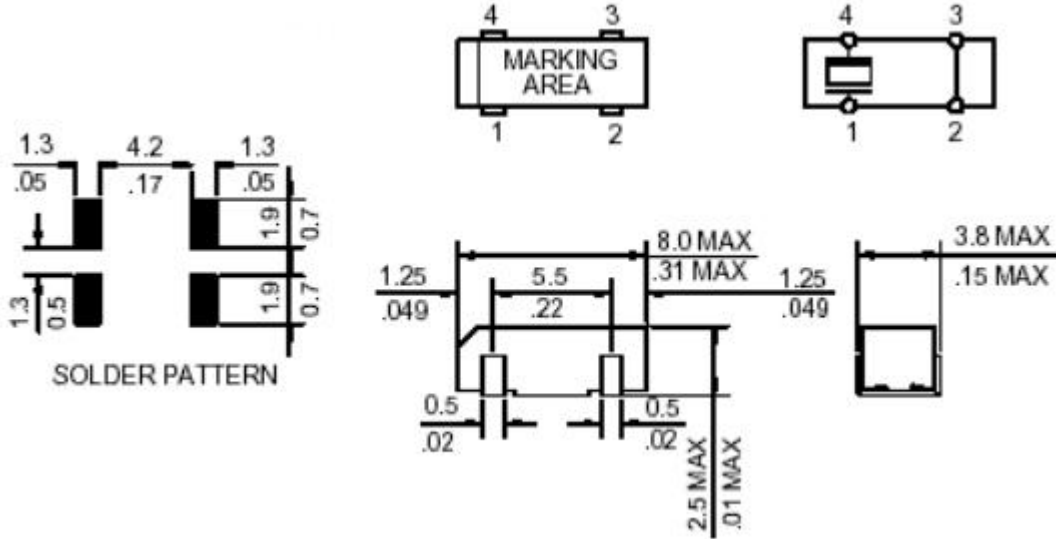

REFLOW SOLDERING PROFILE

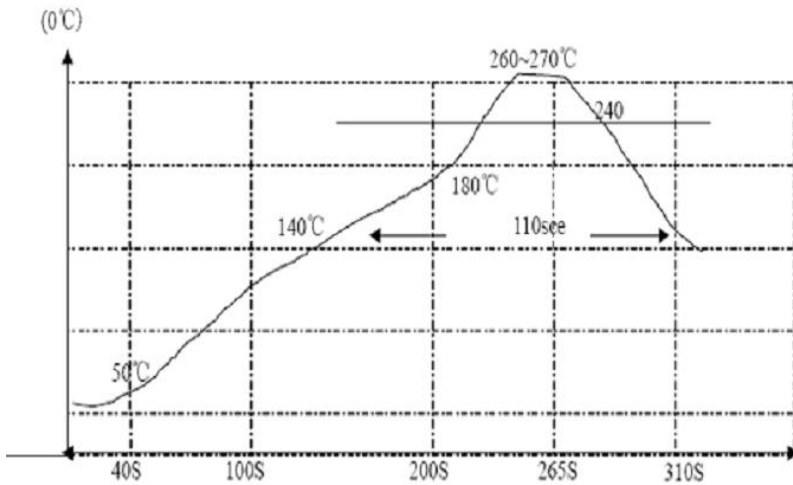

TAPE SPECIFICATIONS (Unit: mm)

