

CUSTOMER : _____

DATE : 2010. 12. 16 .

PRELIMINARY

SPECIFICATIONS FOR APPROVAL

PRODUCT NAME : Top View Type White SMD LED

MODEL NAME : LEMWS52P75HZ00

CUSTOMER P/N : _____

| APPROVAL | REMARK |
|----------|--------|
| | |

APPENDIX

| |
|--|
| |
|--|

| Designed | Checked | Approved | LG Innotek Co., Ltd. | |
|----------|---------|----------|-----------------------------|--------|
| | | | DOCUMENT No. | |
| | | | PAGE | 1 / 17 |



REG. DATE : 10. 12. 16

S P E C I F I C A T I O N

REV.NO : 0.0

REV. DATE : . . .

MODEL : LEMWS52P75HZ00

PAGE : 2 / 17

PRELIMINARY

CONTENTS

| | | |
|---|-------|---------------------|
| 1. Features | ----- | 3 / 17 |
| 2. Outline dimensions | ----- | 3 / 17 |
| 3. Applications | ----- | 4 / 17 |
| 4. Absolute Maximum Ratings | ----- | 4 / 17 |
| 5. Electro-Optical characteristics | ----- | 4 / 17 |
| 6. Rank Sorting Method | ----- | 5 ~ 6 / 17 |
| 7. Typical Characteristic Curves | ----- | 7 / 17 |
| 8. Reliability Test Items and Conditions | ----- | 8 / 17 |
| 9. Package and Marking of Products | ----- | 9 ~ 12 / 17 |
| 10. Cautions on use | ----- | 13 ~ 15 / 17 |
| 11. Others | ----- | 16 / 17 |
| 12. Revision | ----- | 17 / 17 |

PRELIMINARY

1. Features

- Lighting Color : White
- Lead Frame type PKG : 5.4×5.0×1.2 mm (L×W×H)
- Chip Material : InGaN
- Viewing angle : extremely wide(120°)
- Compatible to Pb-free IR reflow soldering
- ESD-withstand voltage : up to 2kV acc. to JESD22-A 114-B
- Taping : 12 mm conductive black carrier tape & antistatic clear cover tape.
1,000pcs/reel, Φ178 mm wheel

2. Outline Dimensions

(Unit : mm)

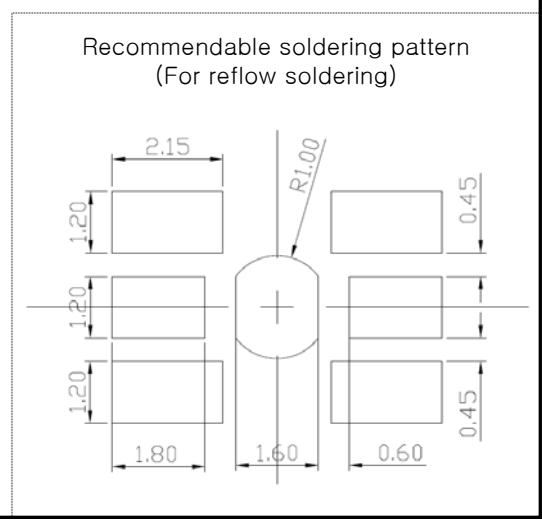
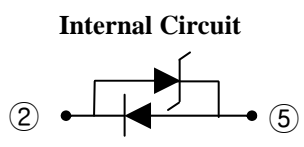
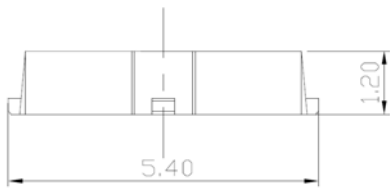
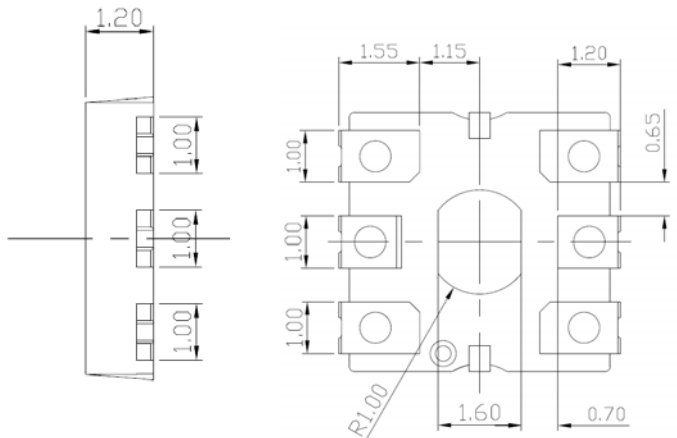
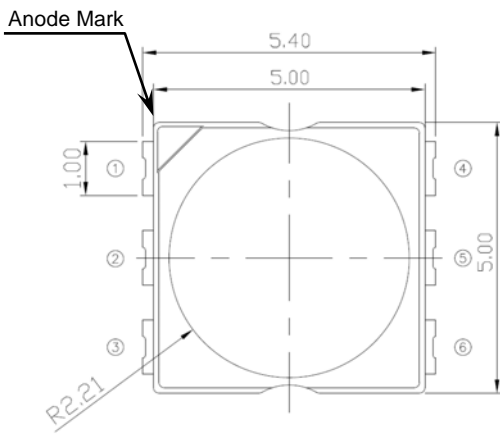

◆Tolerances Unless Dimension ±0.2mm

REG. DATE : 10. 12. 16

SPECIFICATION

REV.NO : 0.0

REV. DATE : . . .

MODEL : LEMWS52P75HZ00

PAGE : 4 / 17

PRELIMINARY

3. Applications

- Interior and Exterior Illumination, Automotive Lighting

4. Absolute Maximum Ratings

(Ta=25°C)

| Items | Symbols | Ratings | Unit |
|---------------------------|-----------|------------|------|
| Forward Current | I_F | 80 | mA |
| Pulse Forward Current *1) | I_{fp} | 140 | mA |
| Power Dissipation | P_D | 272 | mW |
| Operating Temperature | T_{opr} | -30 ~ +85 | °C |
| Storage Temperature | T_{stg} | -40 ~ +100 | °C |

*1) Pulse Width ≤ 10msec, Duty ≤ 10%

5. Electro - Optical Characteristics

(Ta=25°C)

| Items | Symbol | Condition | Min | Typ | Max | Unit |
|-----------------------|---------------|--------------|-----------------------------------|-----|-----|------|
| Forward Voltage | V_F | $I_F=60[mA]$ | 2.9 | - | 3.4 | V |
| Luminous Flux | Φ_v | $I_F=60[mA]$ | 16 | - | - | lm |
| CIE Value | X / Y | $I_F=60[mA]$ | Refer to '6. Rank Sorting Method' | | | - |
| Viewing Angle | $2\Theta 1/2$ | $I_F=60[mA]$ | - | 120 | - | deg |
| Color Rendering Index | Ra | $I_F=60[mA]$ | 75 | - | - | - |

※ These values measured by Optical Spectrum Analyzer of LG Innotek Co., Ltd and tolerances are followings as below

- Luminous Flux (Φ_v) / Intensity (lv) : ± 10%, Forward Voltage(V_F) : ± 0.1V, CIE Value : ± 0.01, CRI Value : ± 3%

▪ Zener Diode

| Items | Symbol | Condition | Min | Typ | Max | Unit |
|-------------------------|--------|-------------|-----|-----|-----|------|
| Forward Voltage | V_F | $I_F=5[mA]$ | 0.6 | - | 1.2 | V |
| Reverse Leakage current | I_R | $V_R=4[V]$ | - | - | 0.1 | uA |

REG. DATE : 10. 12. 16

SPECIFICATION

REV.NO : 0.0

REV. DATE : . . .

MODEL : LEMWS52P75HZ00

PAGE : 5 / 17

PRELIMINARY

6. Rank Sorting Method

■ This product shall be classified by following table

▪ Rank of Luminous Flux (@60mA)

| Rank | Φ_v (lm, @60mA) | | |
|------|----------------------|-----|-----|
| | Min | Typ | Max |
| P | 16 | - | - |

▪ Rank of CIE Value (@60mA)

| CCT | Rank | CIE X | CIE Y |
|---------------------------|--------|--------|--------|
| 5000K (5028K ±283K) | H1 | 0.3376 | 0.3616 |
| | | 0.3463 | 0.3687 |
| | | 0.3447 | 0.3513 |
| | | 0.3369 | 0.3449 |
| | H2 | 0.3369 | 0.3449 |
| | | 0.3447 | 0.3513 |
| | | 0.3440 | 0.3427 |
| | | 0.3366 | 0.3369 |
| | H3 | 0.3463 | 0.3687 |
| | | 0.3551 | 0.3760 |
| | | 0.3526 | 0.3575 |
| | | 0.3447 | 0.3513 |
| | H4 | 0.3447 | 0.3513 |
| | | 0.3526 | 0.3575 |
| | | 0.3515 | 0.3487 |
| | | 0.3440 | 0.3427 |
| | H5 | 0.3381 | 0.3762 |
| | | 0.3480 | 0.3840 |
| | | 0.3463 | 0.3687 |
| | | 0.3376 | 0.3616 |
| | H6 | 0.3366 | 0.3369 |
| | | 0.3440 | 0.3427 |
| | | 0.3429 | 0.3307 |
| | | 0.3361 | 0.3245 |
| H7 | 0.3480 | 0.3840 | |
| | 0.3571 | 0.3907 | |
| | 0.3551 | 0.3760 | |
| | 0.3463 | 0.3687 | |
| H8 | 0.3440 | 0.3427 | |
| | 0.3515 | 0.3487 | |
| | 0.3495 | 0.3339 | |
| | 0.3429 | 0.3307 | |

▪ Rank of CRI (@60mA)

| Rank | Ra (CIR, @60mA) | | |
|------|-----------------|-----|-----|
| | Min | Typ | Max |
| 75 | 75 | - | - |

▪ Rank of Forward Voltage (@60mA)

| Rank | VF (V, @60mA) | | |
|------|---------------|------|------|
| | Min | Typ | Max |
| 0 | 2.90 | 2.95 | 3.00 |
| 1 | 3.00 | 3.05 | 3.10 |
| 2 | 3.10 | 3.15 | 3.20 |
| 3 | 3.20 | 3.25 | 3.30 |
| 4 | 3.30 | 3.35 | 3.40 |

※ Rank name method:

Please refer to the following example

Rank Name : P-H2-3

Φ_v rank = P, CIE rank = H2, VF Rank = 3

PRELIMINARY

Chromaticity Diagram

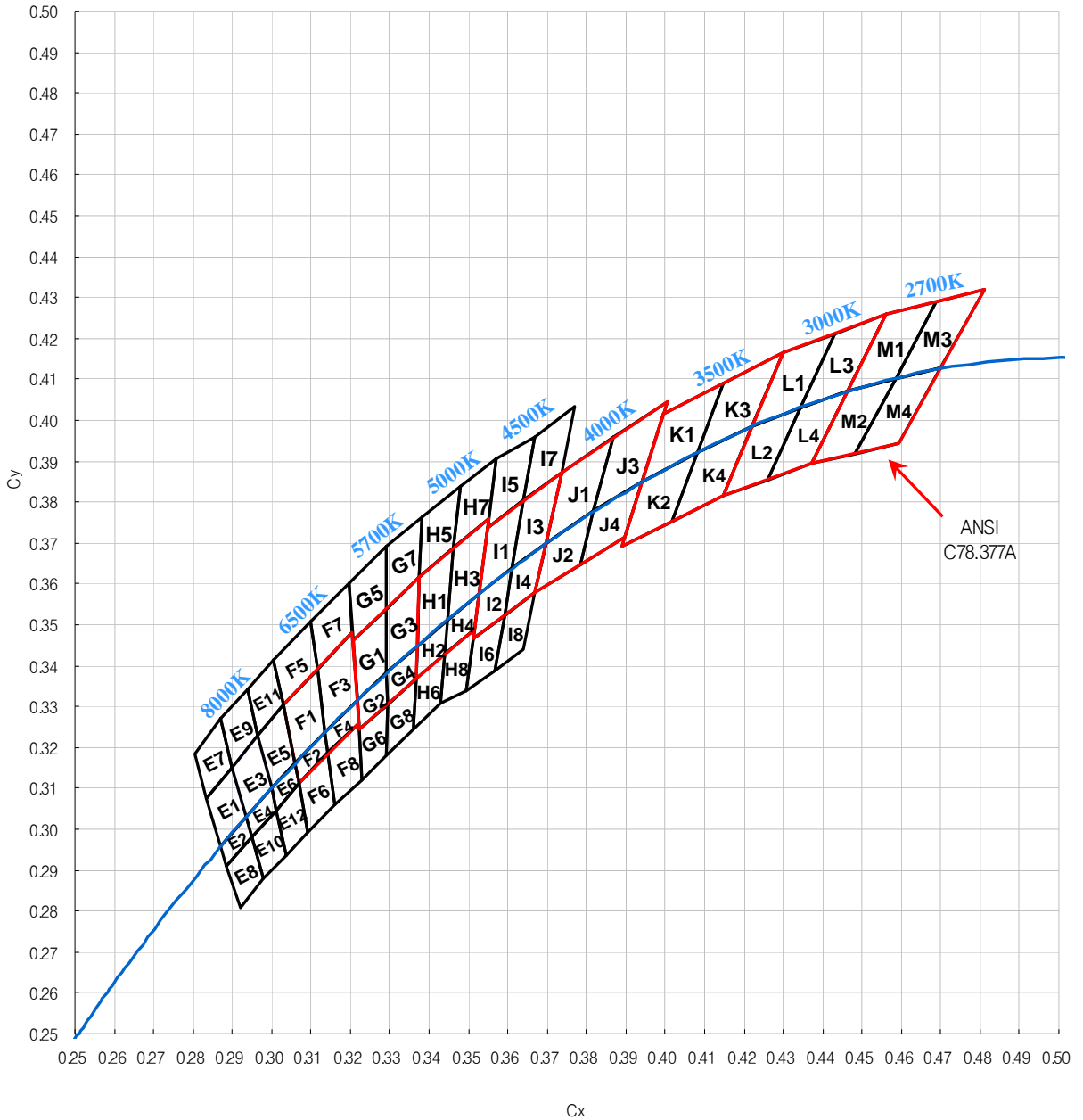

- * Chromaticity coordinate groups are tested at a current pulse duration of 100 ms and a tolerance of ± 0.01 .
- * Voltages are tested at a current pulse duration of 1 ms and an accuracy of $\pm 5.0\%$.
- * This categories are established for classification of products.

PRELIMINARY

7. Typical Characteristic Curves

■ Forward Voltage vs. Forward Current

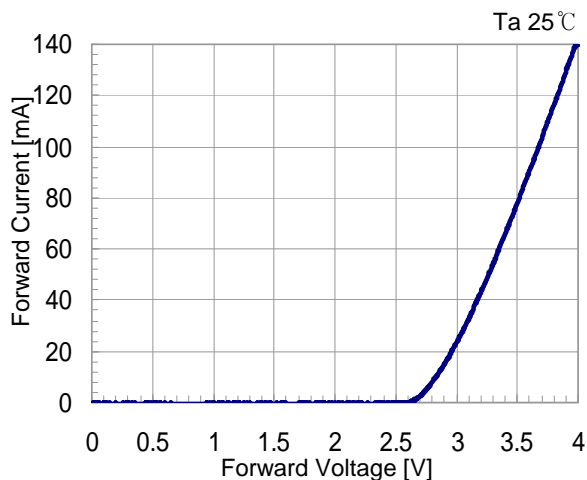

■ Forward Current vs. Luminous Flux

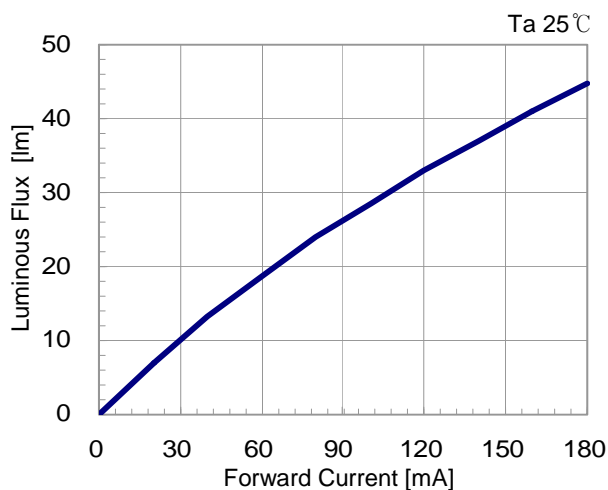

■ Spectrum

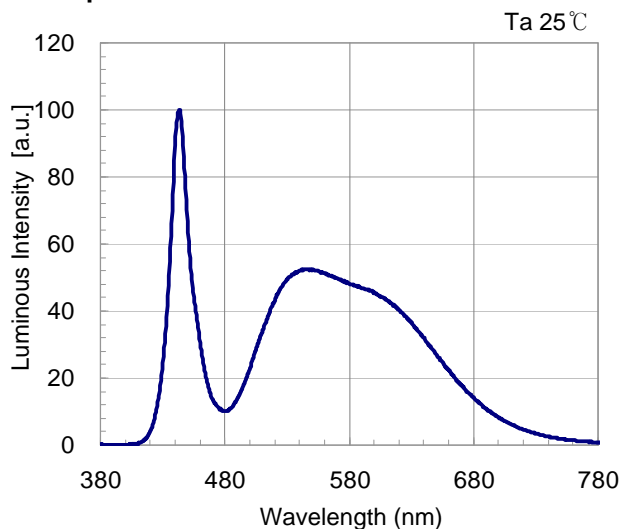

■ Max. Permissible Forward Current

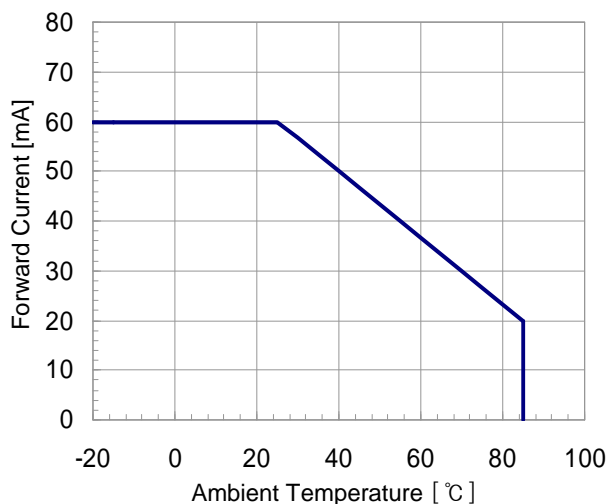

■ Radiation Characteristics

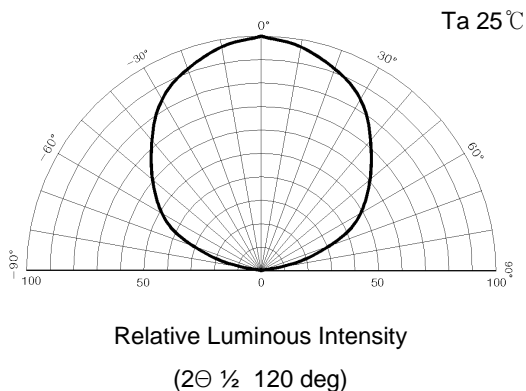

PRELIMINARY

8. Reliability Test Items and Conditions

8-1. The Reliability criteria of SMD LED

| Item | Symbol | Test Condition | Limit | |
|-----------------|----------------|-----------------------|---------|-------------|
| | | | Min | Max |
| Forward Voltage | V _F | I _F = 60mA | - | U.S.L.× 1.2 |
| Luminous Flux | Φ _v | I _F = 60mA | S × 0.7 | - |

*U.S.L : Upper Spec Limit, *L.S.L : Lower Spec Limit *S : Initial Value

8-2. Results of Reliability Test

| No | Item | Test Condition | Test Hours / Cycles | Sample No | Ac / Re |
|----|---|---|---------------------|-----------|---------|
| 1 | Steady State Operating Life | Ta=25℃, I _F =60mA | 1000hr | 22 pcs | 0 / 1 |
| 2 | High Temp. Humidity Life | Ta=60℃, RH=90%, I _F =35mA | 1000hr | 22 pcs | 0 / 1 |
| 3 | Steady State Operating Life of High Temperature | Ta=85℃, I _F =20mA | 1000hr | 22 pcs | 0 / 1 |
| 4 | Steady State Operating Life of Low Temperature | Ta=-30℃, I _F =60mA | 1000hr | 22 pcs | 0 / 1 |
| 6 | High Temp. Storage | Ta=100℃ | 1000hr | 22 pcs | 0 / 1 |
| 7 | Low Temp. Storage | Ta=-40℃ | 1000hr | 22 pcs | 0 / 1 |
| 8 | High Temperature and High Humidity Storage | Ta=85℃, RH=85% | 1000hr | 22 pcs | 0 / 1 |
| 9 | Vibration | 200m/s ² , 100~2000HZ(Sweep 4min) 48 min, 3directions | 4 times | 22 pcs | 0 / 1 |
| 10 | Temperature Cycle | -40℃(30min) ~ 25℃(5min) ~ 100℃(30min) ~ 25℃(5min) | 100cycle | 22 pcs | 0 / 1 |
| 11 | Thermal Shock | 100℃(15min) ~ -40℃(15min) | 50 cycle | 22 pcs | 0 / 1 |
| 12 | Electrostatic Discharge | R=1.5kΩ, C=100pF, Test Voltage 2KV | 3times | 22 pcs | 0 / 1 |
| 13 | Resistance to Soldering Heat (Reflow Soldering) | Told=260℃, 10sec (Pre treatment 30℃,70%,168hr) | 2 times | 22 pcs | 0 / 1 |

PRELIMINARY

9. Package and Marking of Products

9-1. Taping Outline Dimension

Dimension of Reel

(Unit : mm)

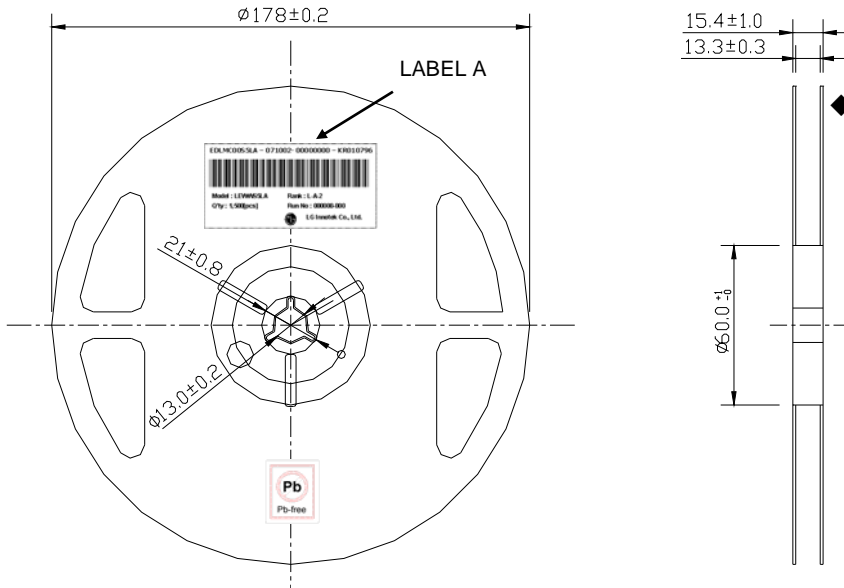

- ◆ Packing Materials :
- Reel : Conductive PS (Black)
 - Emboss Tape : Conductive PS (Black)
 - Cover Tape : Conductive PET Base

Dimension of Tape

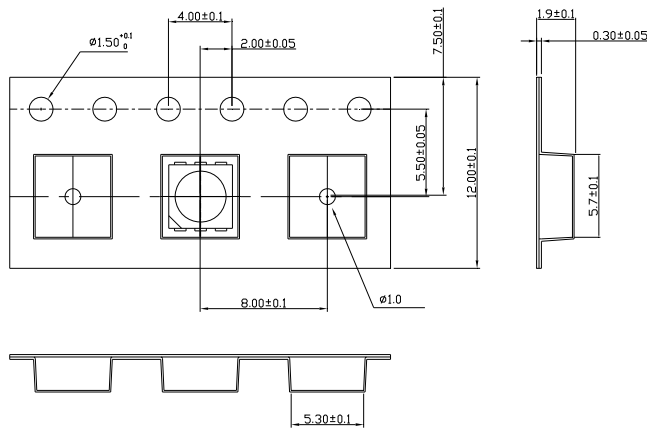

Arrangement of Tape

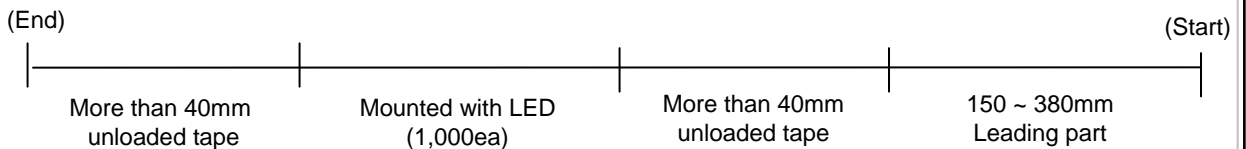

PRELIMINARY

9-2. Package

Products are packed in one bag of 1,000 pcs (one taping reel) and a label is affixed on each bag specifying Model , Rank, Quantity and Run number.

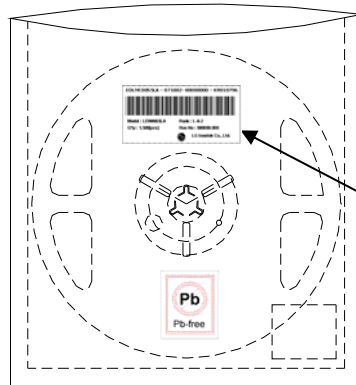

Label A (Model , Rank, Quantity , Run number)

- Package : damp-proof package made of aluminum

※. Label A

Specifying Model , Rank, Quantity and Run number

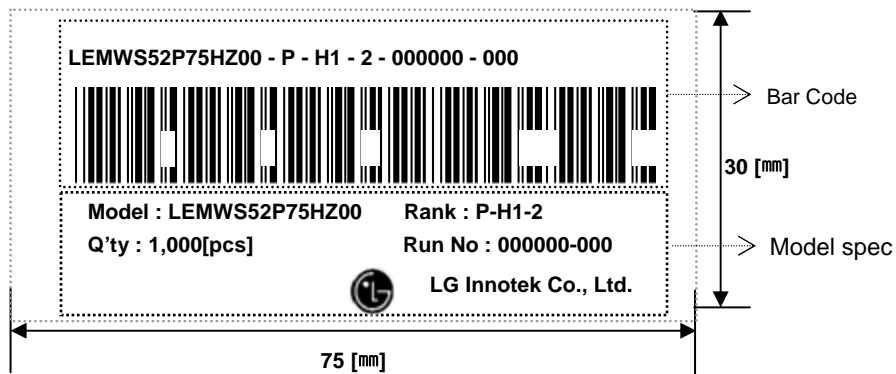

◆ Run no indication

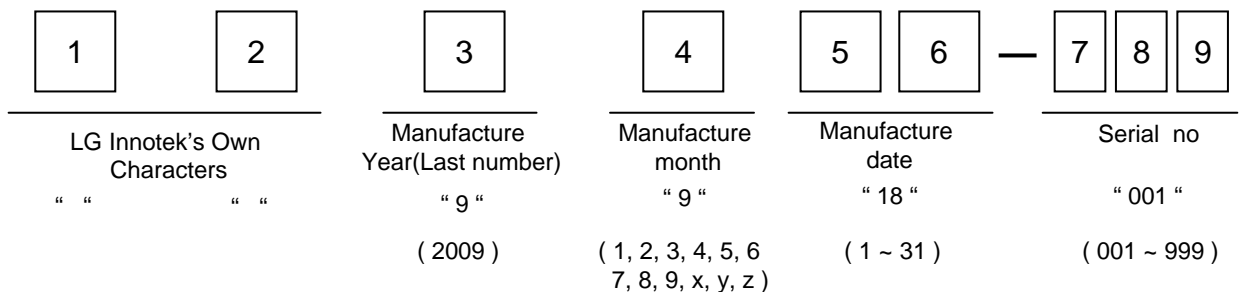

PRELIMINARY

9-3. Packing Specifications

Reeled products (numbers of products are 1,000 pcs) packed in a seal off aluminum moisture-proof bag along with desiccants (Silica gel).

Four aluminum bags (total maximum number of products are 4,000 pcs) packed in an inner box and Six inner boxes are put into an outer box.

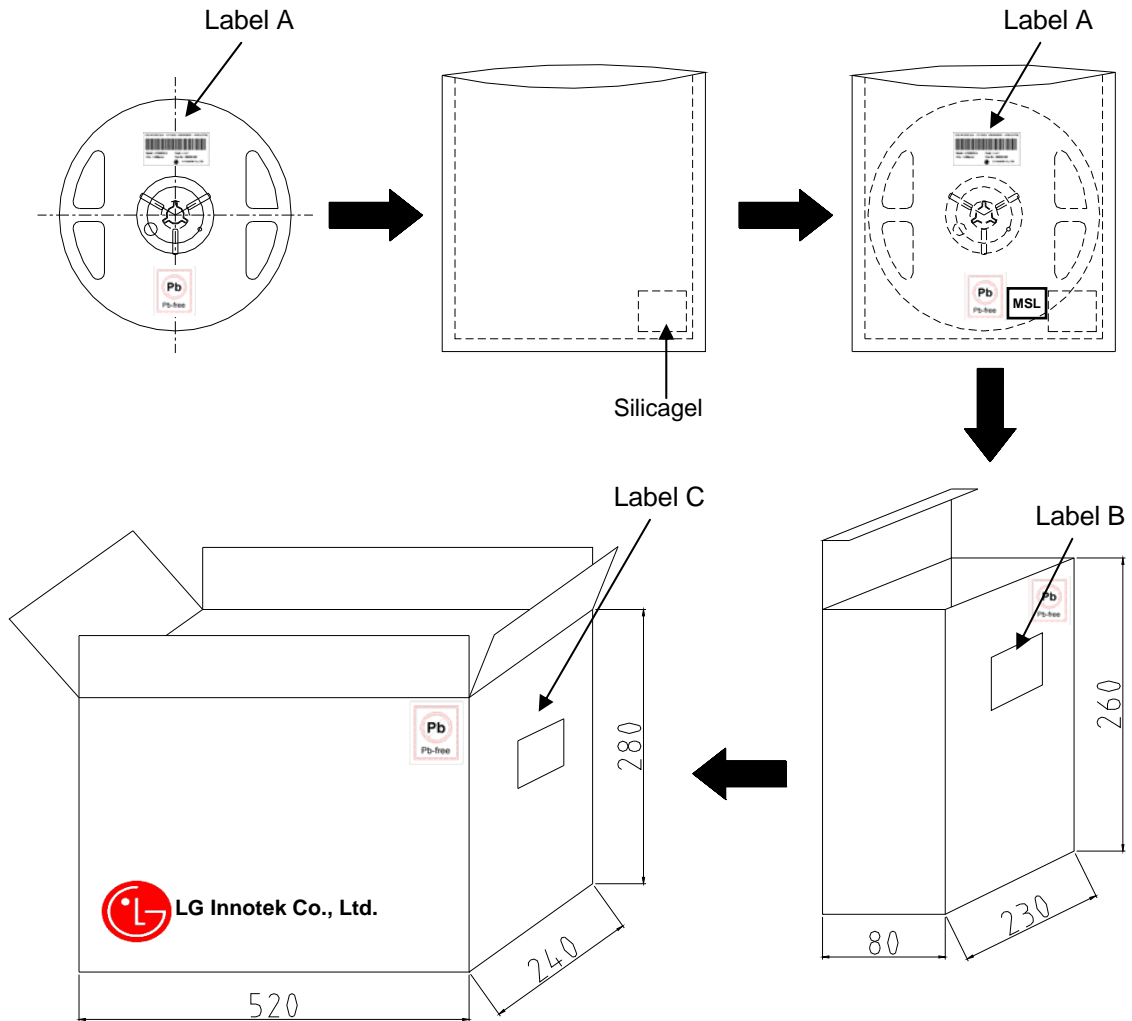

REG. DATE : 10. 12. 16

SPECIFICATION

REV.NO : 0.0

REV. DATE : . . .

MODEL : LEMWS52P75HZ00

PAGE : 12 / 17

PRELIMINARY

※. Label B

Specifying Model , Rank, Quantity

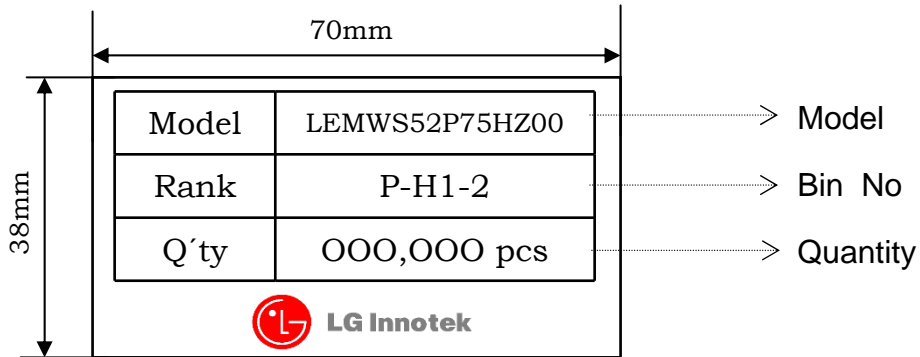



※ Label C

Specifying Customer, Model , Customer part no, Lot No, Quantity

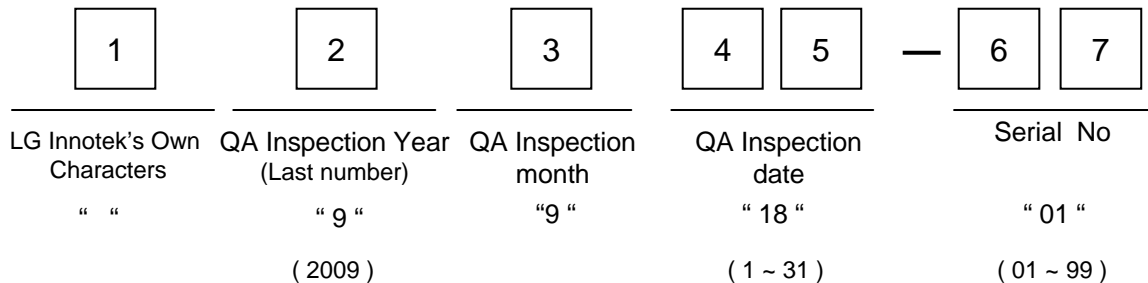

◆ Lot No. indication



| | |
|--|----------------------------------|
|  | DOCUMENT No : |
| REG. DATE : 10. 12. 16 | S P E C I F I C A T I O N |
| REV. DATE : . . . | MODEL : LEMWS52P75HZ00 |
| | REV.NO : 0.0 PAGE : 13 / 17 |

PRELIMINARY

10. Cautions on use

10-1.Circuit Layout

In general, the LEDs have a variation of forward voltage. Using LEDs with different forward voltages in a circuit with on resistor for the complete circuit causes different forward currents for each LED. This may lead to a variation in brightness. To avoid brightness variation of LEDs, the use of matrix circuit with one resistor for each LED is recommended.

10-2. Over-current-proof

Customer must apply resistors for protection, others slight voltage shift will cause big current change (Burn out will happen).

LG Innotek will not be held responsible for any damage to the user that may result from accidents or any other reasons during operation of the user's unit if use to exceed the absolute maximum ratings, or not keep the matters that demand special attention.

10-3. For the Storage

- Proper temperature and RH conditions for storage are : 5 °C ~35 °C , RH 60%.
- Do not open moisture-proof bag before the products are ready to use.
- Store products in a moisture-proof bag with a desiccant(Silica gel) after open.
- These products should be used within 168 hours after opening the bag based upon storage condition.
- These products must be baked to remove moisture before using them if the Silica gel loses its color. Conditions for baking are 60 ± 5 °C , 20% (RH) and 24 hours maximum. (For reeled status without bag)
- Considering the tape life, we suggest our customers to use our products within a year(from production date)

10-4. Cleaning

- Please avoid using a brush for cleaning and do not wash the product in organic solvents such as acetone, Organic solvent (TCE, etc..) will damage the surface of LED. Please refer to following solvents and conditions.

Solvent : alcohol, 25 °C max × 600sec max

PRELIMINARY

10-5. Reverse voltage in Zener Diode embed LED

- If reverse voltage is applied to the LEDs, it will damage the Zener diode and LEDs and result in destruction.

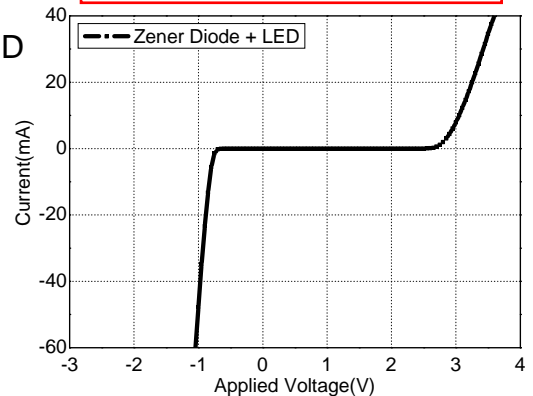

10-6. Static Electricity

- If over-voltage, which exceeds the absolute maximum rating, is applied to the LEDs, it will damage the LEDs and result in destruction. Since the LEDs are sensitive to the static electricity and surge, it is strongly recommended to use a wristband or anti-electrostatic glove when handling the LEDs and all devices, equipment and machinery must be properly grounded.
- Damaged LEDs will show some unusual characteristics such as the leak current remarkably increases, the turn-on voltage becomes lower, or the LEDs do not light at the low current.
- When examining the final product, it is recommended to check whether the assembled LEDs are damaged by static electricity or not. Static-damaged LEDs can easily be found by light-on test or the VF test at a low current.

10-7. Application limits of LED Driver IC controller

- GaN based LED is relatively weak to electrical damage(such as static electricity and over current stress). Forward leakage of LED occurred by such damage in the forward low current region may result in turn-on-delay of LCD back light, which is dependent on a specific function of driver IC.
For reasons mentioned above, minimum current level(source start-up current) of LED driver IC must be more than 0.3 mA. LGIT cannot make a guarantee on the LED using in Driver IC with start up current level of < 0.3 mA.
- When parallel circuit LED driver IC is applied in BLU, hot spot may occur in low current LCD operation region(dimming mode) by difference of LED voltage in low current region. So, driver IC with Individual LED controller is recommended.

PRELIMINARY

10-8. Recommended Circuit Conditions (schematic)

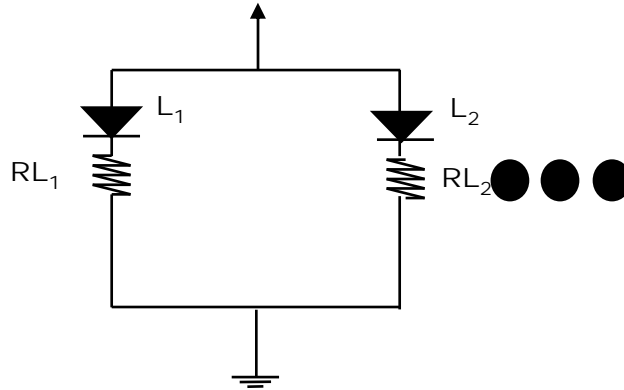

[Pic.1 : Recommended Circuit]
(Separate resistor per each LED)

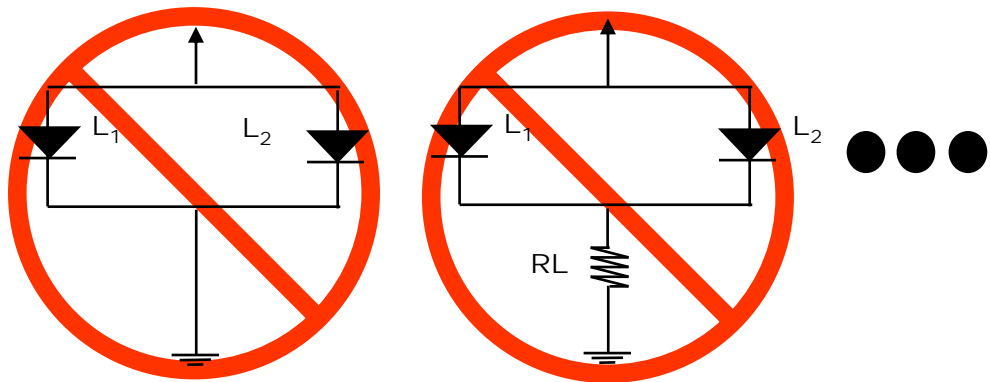

[Pic.2 : Abnormal Circuit]
(Easy to occur brightness problem)

► **Caution on designing PCB & Circuit**

Using more than 2 pcs of 1 LED per a Set. It is strongly recommend to **use separate resistor per each LED.** (Pic. 1)

(For example, condition using 2 pcs in 1 PCB, Please do notice that it is needed total 2 ea of separate resistor, if one resistor is connected to more than 2 pcs of LED (Pic.2), it can cause serious problem on brightness)

PRELIMINARY

11. Others

11-1. Lead Solder

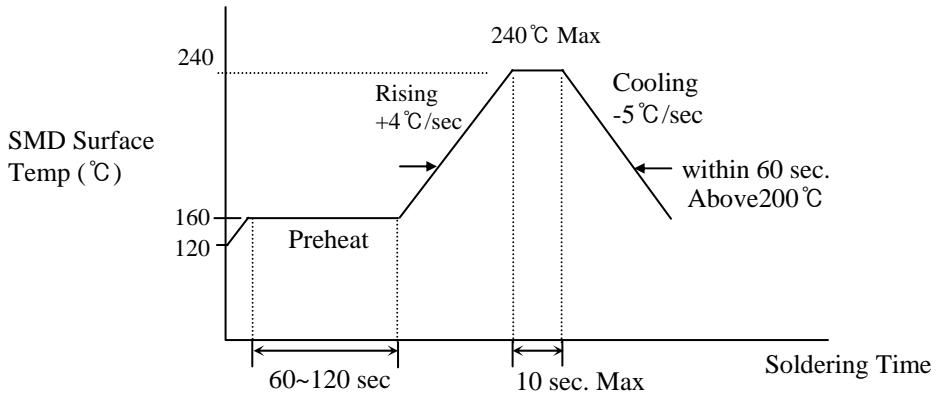

11-2. Lead-free Solder

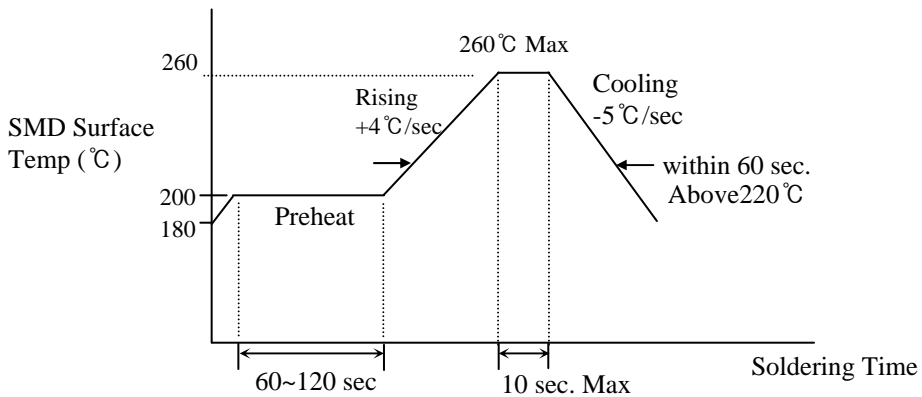

11-3. Soldering Iron

Basic spec is $\leq 5\text{sec}$ when 260°C . If temperature is higher, time shorter (+ $10^\circ\text{C} \rightarrow -1\text{sec}$). Power dissipation of Iron should be smaller than 15W, and temperature should be controllable. Surface temperature of the device should be under 230°C .

11-4. Rework

- 1) Customer must finish rework within 5sec under 245°C .
- 2) The head of Iron can not touch copper foil.
- 3) Twin-head type is preferred.

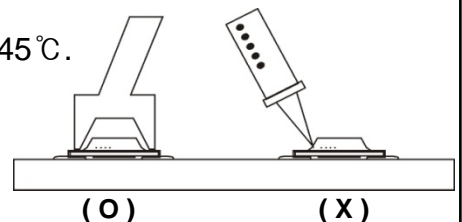

REG. DATE : 10. 12. 16

SPECIFICATION

REV.NO : 0.0

REV. DATE : . . .

MODEL : LEMWS52P75HZ00

PAGE : 17 / 17

PRELIMINARY

12. Change History of Revision

| Revision | Date | Contents of Revision Change | Remark |
|----------|-----------|-----------------------------|--------|
| Rev. 0.0 | '10.12.16 | New establishment | |
| | | | |
| | | | |
| | | | |
| | | | |
| | | | |
| | | | |
| | | | |
| | | | |
| | | | |
| | | | |
| | | | |
| | | | |
| | | | |
| | | | |
| | | | |
| | | | |
| | | | |
| | | | |
| | | | |
| | | | |