

20W isolated DC-DC converter
Wide input and regulated single output

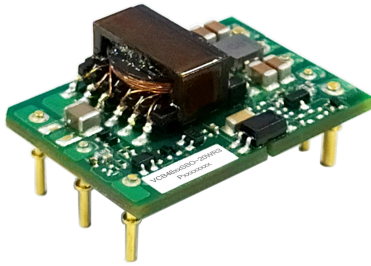

CE Patent Protection RoHS
EN62368-1



FEATURES

- Wide 2:1 input voltage range
- High efficiency up to 90%
- I/O isolation test voltage 1.5K VDC
- Input under-voltage protection, output over-current, short-circuit, over-voltage protection
- Operating ambient temperature range: -40°C to +85°C
- Industry standard 1/16 brick, complies with DOSA standard

VCB48_SBO-20WR3 series are isolated 20W DC-DC converter products with a 2:1 input voltage range. They feature efficiencies of up to 90%, 1500VDC input to output isolation, operating temperature of -40°C to +85°C, input under-voltage protection, output over-current, short-circuit, over-voltage protection, which is widely used in communication field, such as switches, repeaters, intelligent communication gateways, GPS synchronous clock and 4G/5G base station etc.

Selection Guide

Certification	Part No.	Input Voltage (VDC)		Output		Full Load Efficiency ^② (%) Min./Typ.	Max. Capacitive Load(μF)
		Nominal (Range)	Max. ^①	Voltage (VDC)	Current(mA) Max./Min.		
EN	VCB4803SBO-20WR3	48 (36-75)	80	3.3	5000/0	84/86	7200
	VCB4805SBO-20WR3			5	4000/0	86/88	7200
	VCB4812SBO-20WR3			12	1667/0	87/89	1600
	VCB4815SBO-20WR3			15	1333/0	87/89	1000
	VCB4824SBO-20WR3			24	833/0	88/90	470
	VCB4828SBO-20WR3			28	714/0	88/90	470

Notes:

- ① Exceeding the maximum input voltage may cause permanent damage;
② Efficiency is measured at nominal input voltage and rated output load.

Input Specifications

Item	Operating Conditions	Min.	Typ.	Max.	Unit
Input Current (full load / no load)	Nominal input voltage	--	474/15	485/30	mA
Reflected Ripple Current		--	50	--	
Surge Voltage (1sec. max.)		-0.7	--	100	VDC
Start-up Voltage		--	--	36	
Under-voltage Protection		26	29	--	
Start-up Time	Nominal input voltage & constant resistance load	--	--	100	ms
Input Filter		C filter			
Hot Plug		Unavailable			
Ctrl*	Module on	Ctrl pin open or pulled high (TTL 3.5-12VDC)			
	Module off	Ctrl pin pulled low to GND (0-1.2VDC)			
	Input current when off	--	6	10	mA

Note: *The Ctrl pin voltage is referenced to input GND.

Output Specifications

Item	Operating Conditions	Min.	Typ.	Max.	Unit	
Voltage Accuracy	5%-100% load	--	±1	±3	%	
Linear Regulation	Input voltage variation from low to high at full load	--	±0.2	±0.5		
Load Regulation ^①	5%-100% load	--	±0.5	±1		
Transient Recovery Time	25% load step change, nominal input voltage		--	300	500	μs
Transient Response Deviation	25% load step change, nominal input voltage	3.3V, 5V output	--	±5	±8	%
		Others	--	±3	±5	
Temperature Coefficient	Full load	--	--	±0.03	%/°C	
Ripple & Noise ^②	20MHz bandwidth, 5%-100% load	--	100	150	mV p-p	
Trim		90	--	110	%Vo	
Output Voltage Remote Compensation(sense)		--	--	105		
Over-voltage Protection		110	--	160		
Over-current Protection	Input voltage range	110	140	190	%Io	
Short-circuit Protection		Continuous, self-recovery				

Note:
 ① Load regulation for 0%-100% load is ±3%;
 ② Ripple & Noise at < 5% load is 5%Vo max. The "parallel cable" method is used for ripple and noise test, please refer to *DC-DC Converter Application Notes* for specific information.

General Specifications

Item	Operating Conditions	Min.	Typ.	Max.	Unit
Isolation	Input-output Electric Strength Test for 1 minute with a leakage current of 1mA max.	1500	--	--	VDC
Insulation Resistance	Input-output resistance at 500VDC	1000	--	--	MΩ
Isolation Capacitance	Input-output capacitance at 100KHz/0.1V	--	1000	--	pF
Operating Temperature	See Fig. 1	-40	--	+85	°C
Storage Temperature		-55	--	+125	
Storage Humidity	Non-condensing	5	--	95	%RH
Vibration		10-150Hz, 5G, 0.75mm. along X, Y and Z			
Switching Frequency*	PWM mode	--	230	--	KHz
MTBF	MIL-HDBK-217F@25°C	1000	--	--	K hours

Note:*Switching frequency is measured at full load. The module reduces the switching frequency for light load (below 50%) efficiency improvement.

Mechanical Specifications

Dimensions	33.02 x 22.86 x 12.60mm
Weight	8.2g (Typ.)
Cooling Method	Free air convection

Electromagnetic Compatibility (EMC)

Emissions	CE	CISPR32/EN55032	CLASS B (see Fig.3-① for recommended circuit)	
	RE	CISPR32/EN55032	CLASS B (see Fig.3-① for recommended circuit)	
Immunity	ESD	IEC/EN61000-4-2	Contact ±4KV	perf. Criteria B
	RS	IEC/EN61000-4-3	10V/m	perf. Criteria A
	EFT	IEC/EN61000-4-4	±2KV (see Fig.3-② for recommended circuit)	perf. Criteria B
	Surge	IEC/EN61000-4-5	line to line ±2KV (see Fig.3-② for recommended circuit)	perf. Criteria B
	CS	IEC/EN61000-4-6	3 Vr.m.s	perf. Criteria A

Typical Characteristic Curves

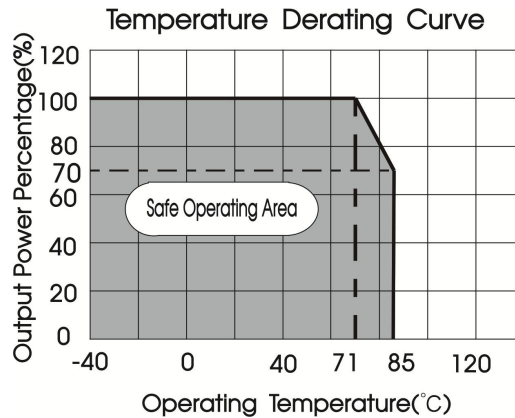
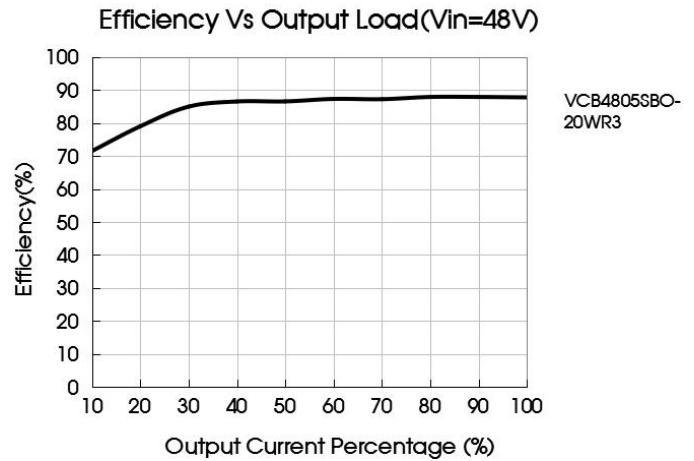
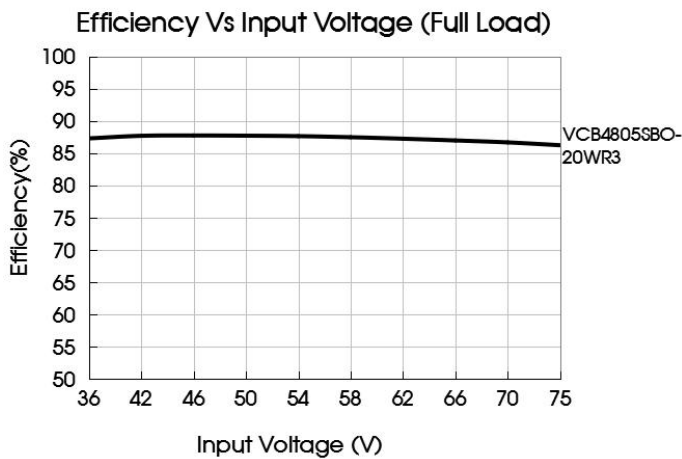

Fig.1

Note: Measuring PCB size is 127mm X 67mm X 2mm, copper thickness is 1OZ, two-ply (putting tin on top and bottom surface during welding)



Remote Sense Application

1. Remote Sense Connection if not used

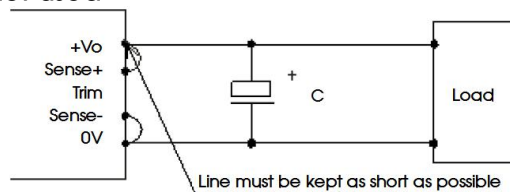

Notes:

- (1) If the sense function is not used for remote regulation the user must connect the +Sense to +Vo and -Sense to 0V at the DC-DC converter pins and will compensate for voltage drop across pins only.
- (2) The connections between Sense lines and their respective power lines must be kept as short as possible, otherwise they may be picking up noise, interference and/or causing unstable operation of the power module.

2. Remote Sense Connection used for Compensation

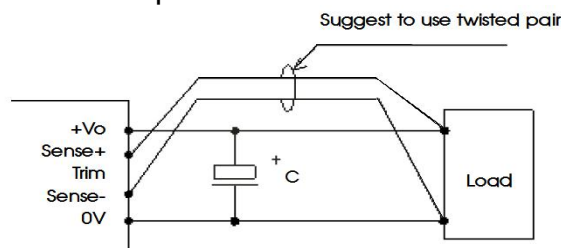

Notes:

- (1) Using remote sense with long wires may cause unstable output, please contact technical support if long wires must be used.
- (2) PCB-tracks or cables/wires for Remote Sense must be kept as short as possible. Twisted pair or shielded wires are suggested for remote compensation and must be kept as short as possible.
- (3) We recommend using adequate cross section for PCB-track layout and/or cables to connect the power supply module to the load in order to keep the voltage drop below 0.3V and to make sure the power supply's output voltage remains within the specified range.
- (4) Note that large wire impedance may cause oscillation of the output voltage and/or increased ripple. Consult technical support or factory for further advice of sense operation.

Design Reference

1. Typical application

All DC-DC converters of this series are tested before delivery using the recommended circuit shown in Fig. 2.

Input and/or output ripple can be further reduced by appropriately increasing the input & output capacitor values C_{in} and C_{out} and/or by selecting capacitors with a low ESR (equivalent series resistance). Also make sure that the capacitance is not exceeding the specified max. capacitive load value of the product.

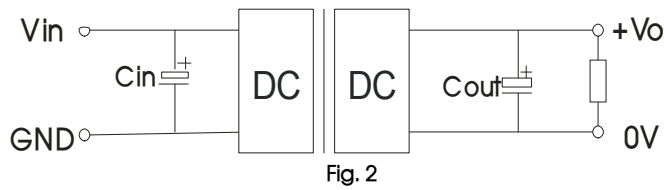

Vin	48V
Cin	100μF/100V
Cout	10μF/50V

2. EMC compliance circuit

Parameter description:

Model	Vin:48V
FUSE	Select fuse value according to actual input current
MOV	S14K60
C0	680μF/100V
C1, C2	22μF/100V
C3	330μF/100V
C4	Refer to the Cout in Fig.2
LCM1	4.7mH, recommended to use MORNSUN FL2D-30-472
LDM1	22 μH
CY1, CY2	2.2nF/2kV

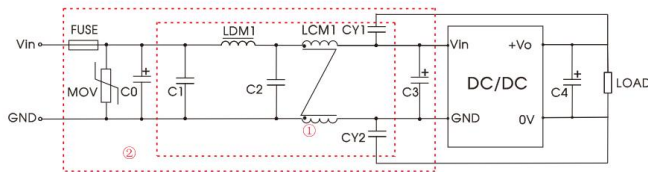
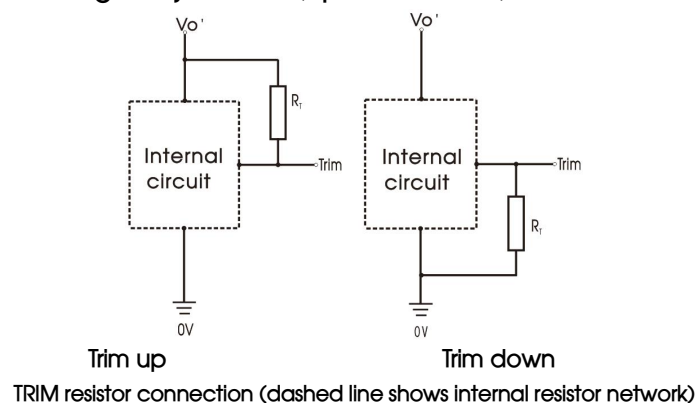

Fig. 3

Notes: For EMC tests we use Part ② in Fig. 3 for immunity and part ① for emissions test. Selecting based on needs.

3. Trim Function for Output Voltage Adjustment (open if unused)



Trim resistor calculation:

Trim up

$$R_T = \left(\frac{5.11V_{nom}(100 + \Delta\%)}{1.225\Delta\%} - \frac{511}{\Delta\%} - 10.22 \right) (k\Omega)$$

Trim down

$$R_T = \left(\frac{511}{\Delta\%} \right) - 10.22 (k\Omega)$$

Note:

RT = Trim Resistor value

$$\Delta\% = \left| \frac{V_{nom} - V_{out}}{V_{nom}} \right| \times 100$$

V_{nom} = nominal output voltage

V_{out} = desired output voltage

- The products do not support parallel connection of their output
- For additional information please refer to DC-DC converter application notes on www.mornsun-power.com

Dimensions and Recommended Layout

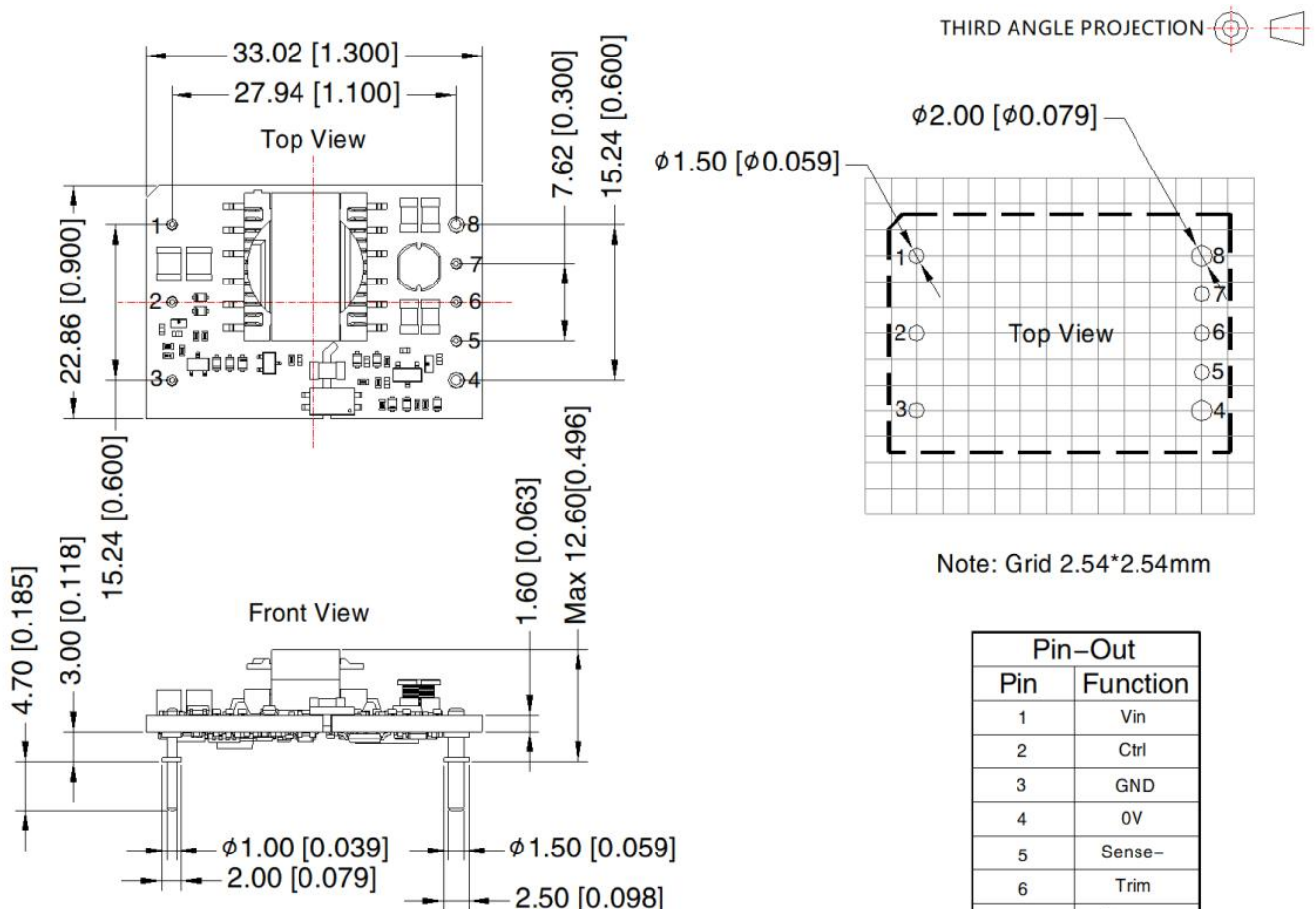

Note:

Unit: mm[inch]

Pin section tolerances: ± 0.10 [± 0.004]

General tolerances: ± 0.50 [± 0.020]

The layout of the device is for reference only, please refer to the actual product

Note:

1. For additional information on Product Packaging please refer to www.mornsun-power.com. Packaging bag number: 58210102;
2. The maximum capacitive load offered were tested at input voltage range and full load;
3. Unless otherwise specified, parameters in this datasheet were measured under the conditions of $T_a=25^{\circ}\text{C}$, humidity<75%RH with nominal input voltage and rated output load;
4. All index testing methods in this datasheet are based on company corporate standards;
5. We can provide product customization service, please contact our technicians directly for specific information;
6. Products are related to laws and regulations: see "Features" and "EMC";
7. Our products shall be classified according to ISO14001 and related environmental laws and regulations, and shall be handled by qualified units.

Mornsun Guangzhou Science & Technology Co., Ltd.

Address: No. 5, Kehui St. 1, Kehui Development Center, Science Ave., Guangzhou Science City, Huangpu District, Guangzhou, P. R. China
Tel: 86-20-38601850 Fax: 86-20-38601272 E-mail: info@mornsun.cn www.mornsun-power.com