



LA4700N

2-Channel 12W AF Power Amplifier for Car Stereos

Functions

- Standby switch function built in
- Pop noise suppressor built in
- Thermal shutdown circuit built in
- Overvoltage/surge protector built in
- Output pin-to-GND short protector built in
- Output pin-to-V_{CC} short protector built in
- Load short protector built in

Features

- Low pop noise at the time of power supply ON/OFF
- Excellent oscillation stability

Specifications

Maximum Ratings at Ta = 25°C

Parameter	Symbol	Conditions	Ratings	Unit
Maximum supply voltage	V _{CC} max1	Quiescent t = 30 s	26	V
	V _{CC} max2	Quiescent	18	V
	V _{CC} max3	Operating	16	V
Surge supply voltage	V _{CC} surge	t = 200 ms rise time 1 ms	50	V
Maximum output current	I _o peak	Per channel	4	A
Allowable power dissipation	P _d max	*Note	37.5	W
Operating temperature	T _{opr}		-30 to +75	°C
Storage temperature	T _{stg}		-40 to +150	°C

Operating Conditions at Ta = 25°C

Parameter	Symbol	Conditions	Ratings	Unit
Recommended operating voltage	V _{CC}		13.2	V
Operating voltage range	V _{CC} op		10 to 16	V
Recommended load resistance	R _L	BTL/2ch	4 to 8	Ω

*Note: Use flat head screws for attaching heat sink with tightening torque 39 to 59 N•cm.

■ Any and all SANYO products described or contained herein do not have specifications that can handle applications that require extremely high levels of reliability, such as life-support systems, aircraft's control systems, or other applications whose failure can be reasonably expected to result in serious physical and/or material damage. Consult with your SANYO representative nearest you before using any SANYO products described or contained herein in such applications.

■ SANYO assumes no responsibility for equipment failures that result from using products at values that exceed, even momentarily, rated values (such as maximum ratings, operating condition ranges, or other parameters) listed in products specifications of any and all SANYO products described or contained herein.

Package Dimensions

unit : mm

3109-SIP18H

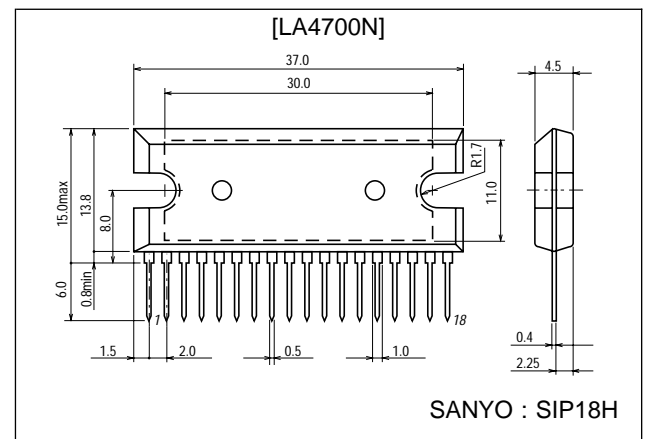

LA4700N

**Operating Characteristics at $T_a = 25^\circ\text{C}$, $V_{CC} = 13.2\text{ V}$, $R_L = 4\ \Omega$, $f = 1\text{ kHz}$, $R_g = 600\ \Omega$,
See specified Test Circuit**

Parameter	Symbol	Conditions	min	typ	max	Unit
Quiescent current	I_{CCO}		60	140	200	mA
Voltage gain	VG		48	50	52	dB
Voltage gain difference	ΔVG				2	dB
Total harmonic distortion	THD	$P_o = 1\text{ W}$		0.15	0.75	%
Output voltage	P_o	THD = 10%	10	12		W
Output noise voltage	V_{NO}	$R_g = 0$, B.P.F. = 20 Hz to 20 kHz		0.2	0.4	mV
Ripple rejection	SVRR	$V_r = 0\text{ dBm}$, $f_R = 100\text{ Hz}$, $R_g = 0$	40	55		dB
Channel separation	CHsep	$P_o = 1\text{ W}$, $R_g = 10\text{ k}\Omega$	50	60		dB
Standby current	1st			10	100	μA
Offset voltage	V_{off}		-300		300	mV

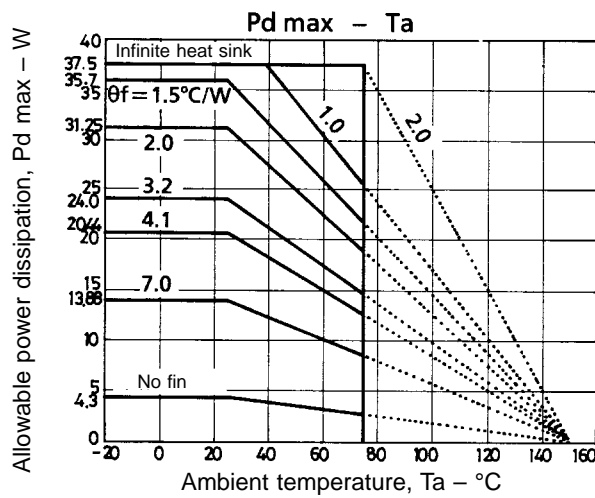

Equivalent Circuit Block Diagram

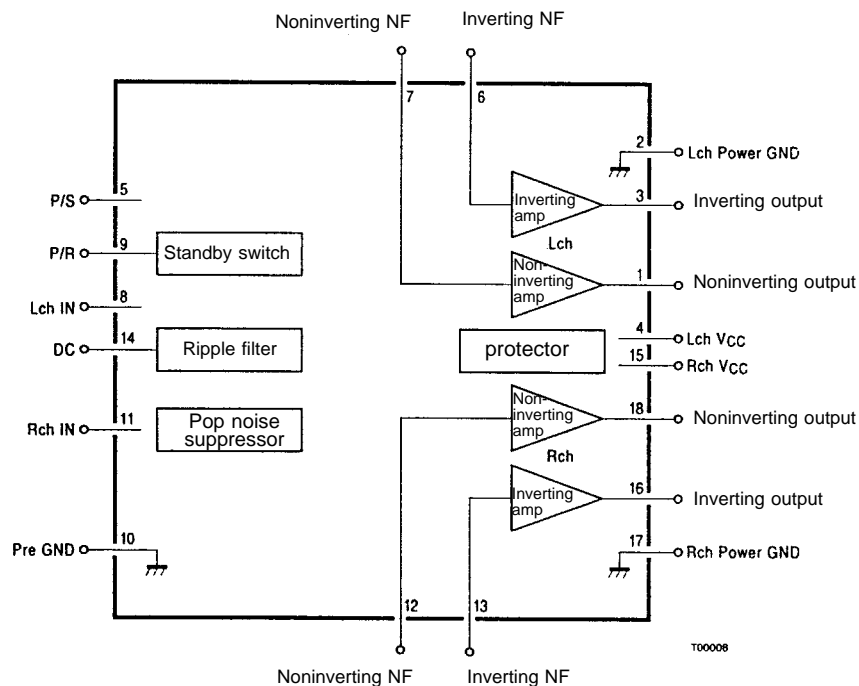

Sample Application Circuit

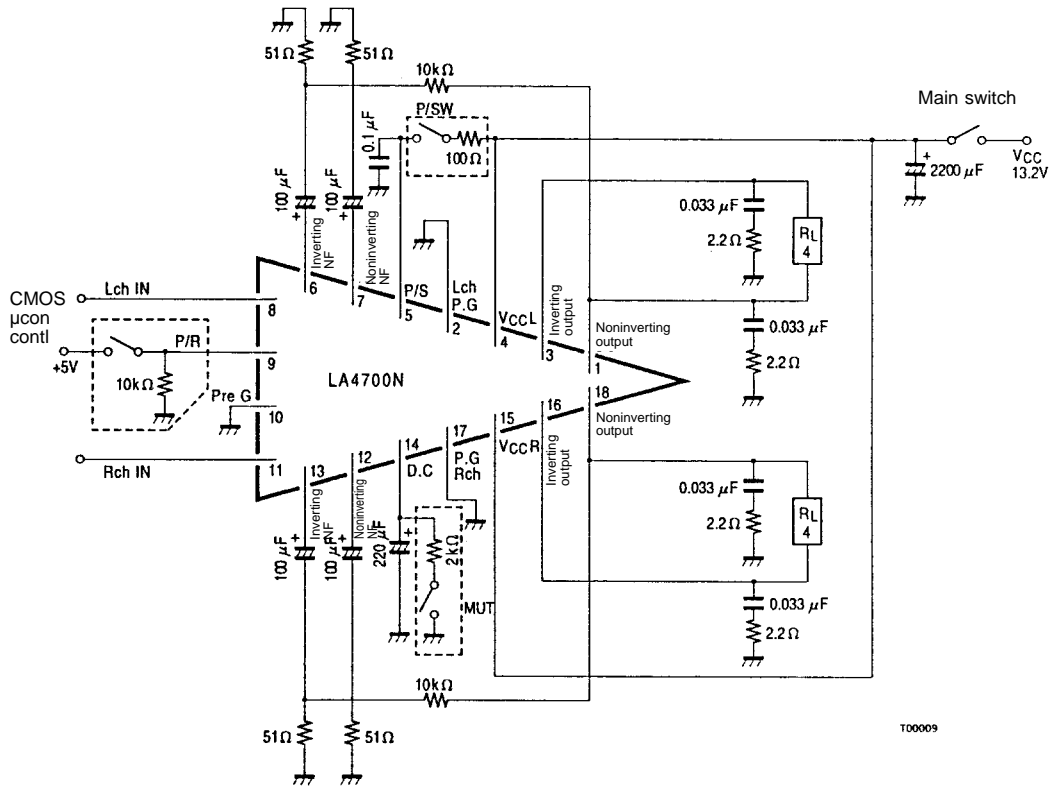

* Connect the portion bounded by a dotted line according to your intended applications. When the power relay is not used, connect pin ⑨ to GND. In this case, the power switch is used to turn ON/OFF the LA4700N or the main switch is used to turn ON/OFF the LA4700N.

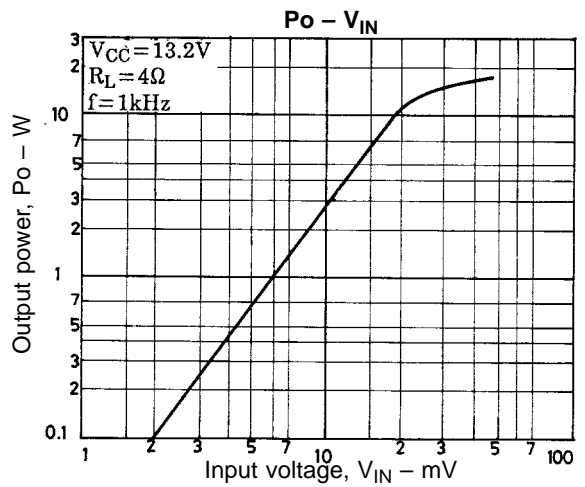
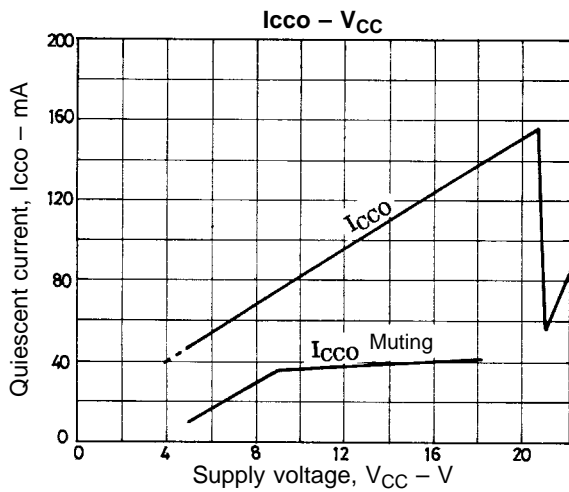

LA4700N

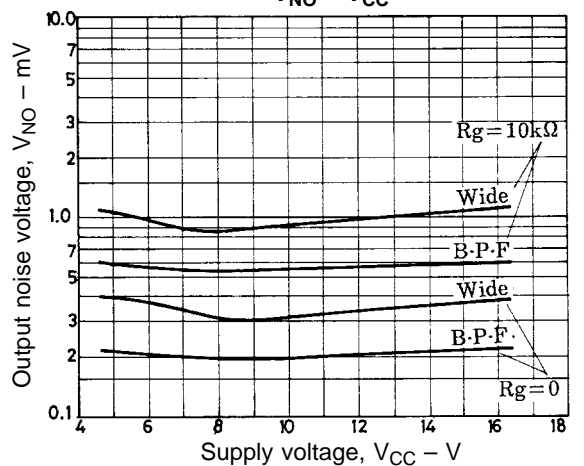
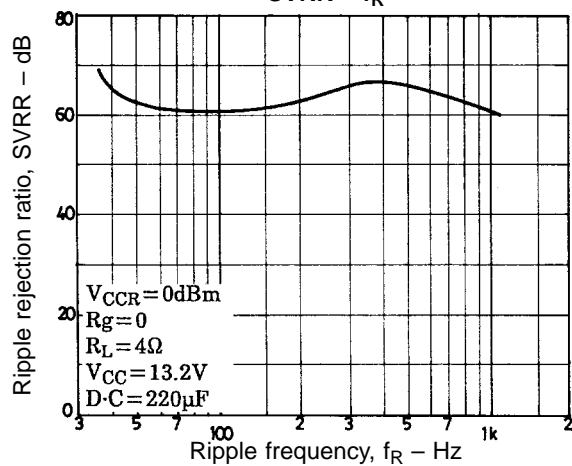
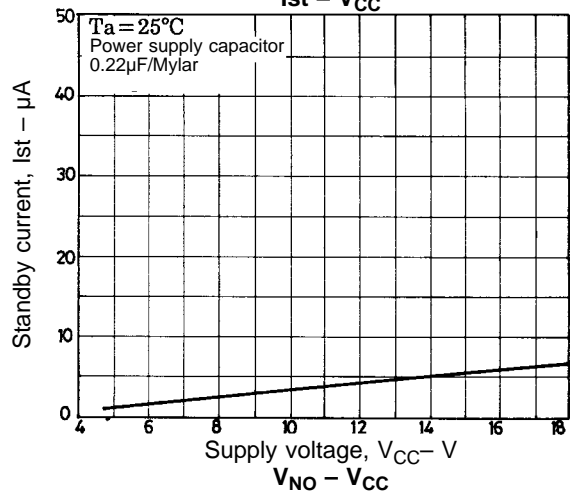
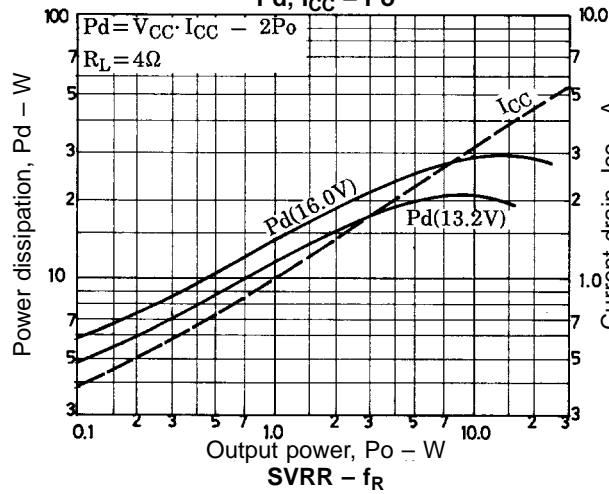
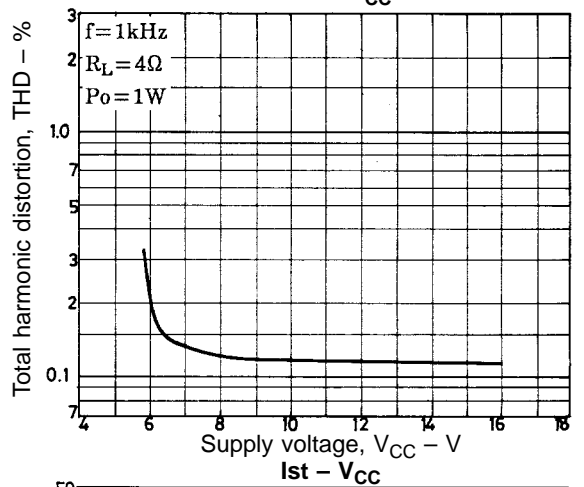
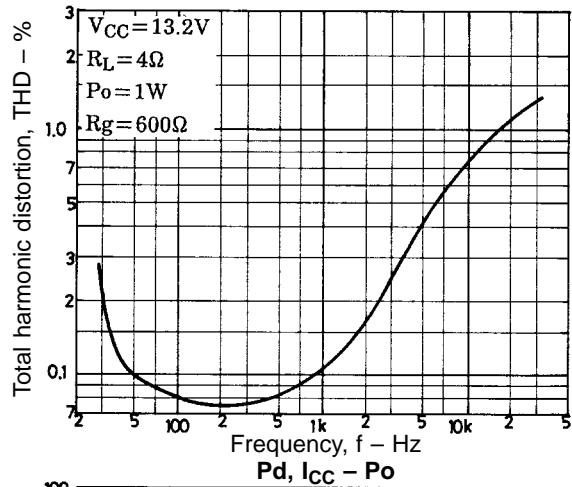
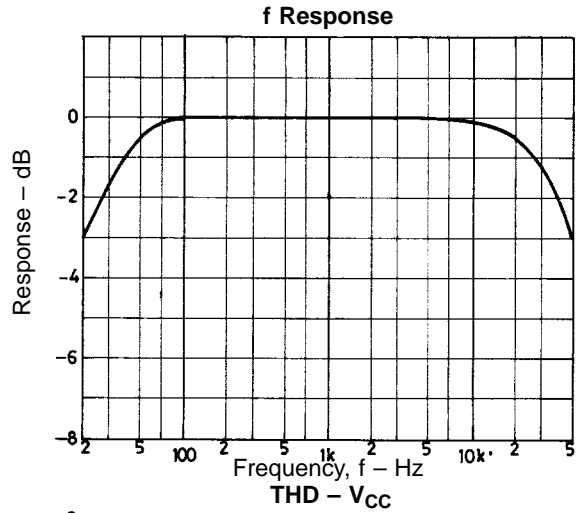
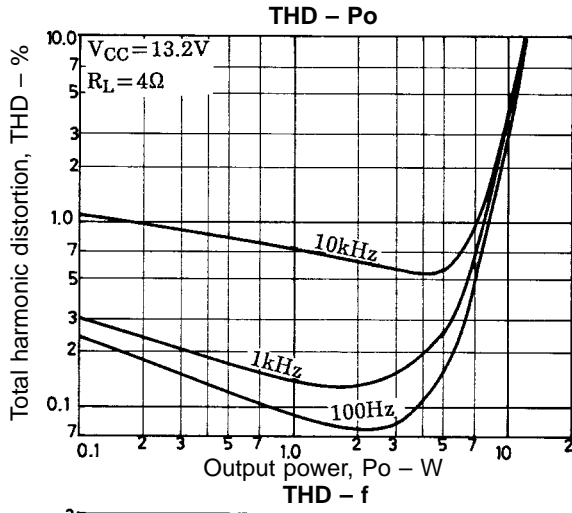

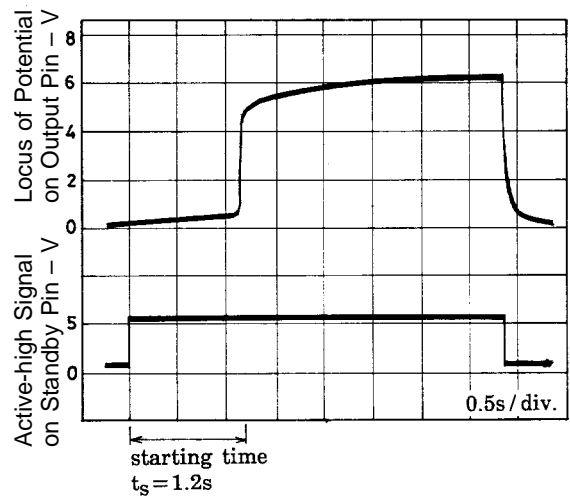
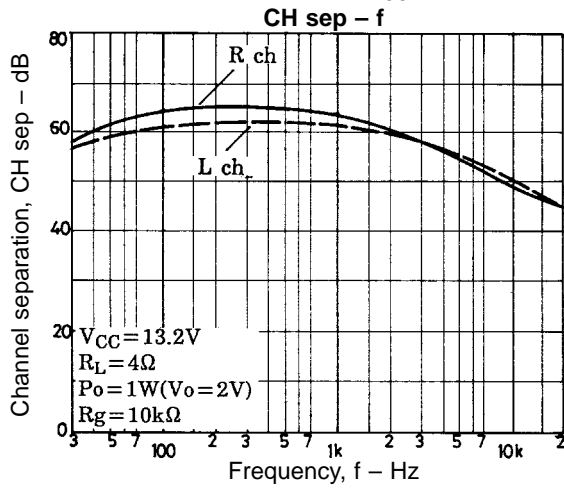
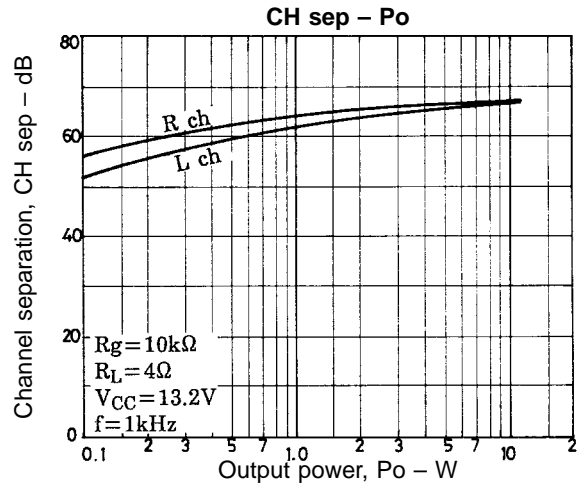
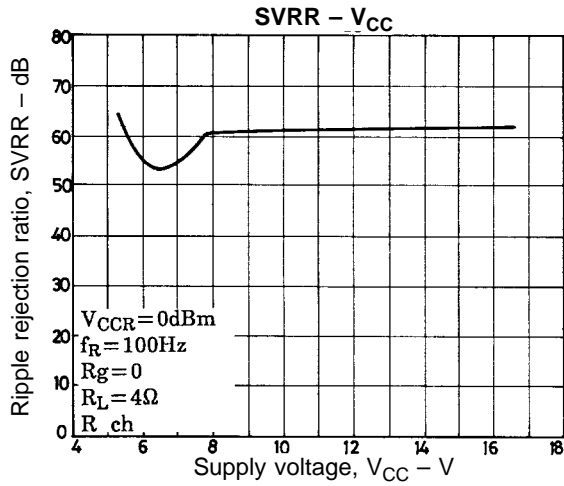

To shorten t_s in the application herein, the filter capacitor (pin 14) value 220 μF is decreased. Filter capacitor value 100 μF gives t_s of 0.6 to 0.7 second.

- Specifications of any and all SANYO products described or contained herein stipulate the performance, characteristics, and functions of the described products in the independent state, and are not guarantees of the performance, characteristics, and functions of the described products as mounted in the customer's products or equipment. To verify symptoms and states that cannot be evaluated in an independent device, the customer should always evaluate and test devices mounted in the customer's products or equipment.
- SANYO Electric Co., Ltd. strives to supply high-quality high-reliability products. However, any and all semiconductor products fail with some probability. It is possible that these probabilistic failures could give rise to accidents or events that could endanger human lives, that could give rise to smoke or fire, or that could cause damage to other property. When designing equipment, adopt safety measures so that these kinds of accidents or events cannot occur. Such measures include but are not limited to protective circuits and error prevention circuits for safe design, redundant design, and structural design.
- In the event that any or all SANYO products(including technical data, services) described or contained herein are controlled under any of applicable local export control laws and regulations, such products must not be exported without obtaining the export license from the authorities concerned in accordance with the above law.
- No part of this publication may be reproduced or transmitted in any form or by any means, electronic or mechanical, including photocopying and recording, or any information storage or retrieval system, or otherwise, without the prior written permission of SANYO Electric Co., Ltd.
- Any and all information described or contained herein are subject to change without notice due to product/technology improvement, etc. When designing equipment, refer to the "Delivery Specification" for the SANYO product that you intend to use.
- Information (including circuit diagrams and circuit parameters) herein is for example only ; it is not guaranteed for volume production. SANYO believes information herein is accurate and reliable, but no guarantees are made or implied regarding its use or any infringements of intellectual property rights or other rights of third parties.

This catalog provides information as of April, 1996. Specifications and information herein are subject to change without notice.