

# DATA SHEET

## **TDA4860**

Vertical deflection power amplifier  
for monitors

Product specification  
Supersedes data of September 1991  
File under Integrated Circuits, IC02

1996 Nov 26

# Vertical deflection power amplifier for monitors

## TDA4860

### FEATURES

- Vertical pre-amplifier with differential inputs
- Powerless vertical shift
- Flyback voltage generation suitable for two operating modes (doubling the supply voltage or external supply for the short flyback time, this achieves a minimum of power dissipation)
- Vertical output stage with thermal and SOAR protection
- High deflection frequency up to 140 Hz
- High linear sawtooth signal amplification
- Possibility of guarding the deflection
- Voltage stabilizer.

### GENERAL DESCRIPTION

The TDA4860 is a vertical power amplifier for differential input signals suitable for colour monitor/TV systems with deflection frequencies up to 140 Hz.

### QUICK REFERENCE DATA

Measurements referenced to substrate (pin 6).

SYMBOL	PARAMETER	MIN.	TYP.	MAX.	UNIT
$V_{P1}$	supply voltage (pin 1)	9	–	30	V
$V_{P2}$	supply voltage (pin 4)	9	–	60	V
$V_{P3}$	flyback supply voltage (pin 8)	9	–	60	V
$I_{P1}$	supply current (pin 1)	–	–	10	mA
$I_{P2}$	supply quiescent current (pin 4)	–	9	–	mA
$V_I$	input voltage (pins 2 and 3)	1.6	–	$V_{P1} - 0.5$	V
$I_{5M}$	deflection output current (maximum value; pin 5)	–	–	$\pm 1$	A
$T_{amb}$	operating ambient temperature	–20	–	+75	°C

### ORDERING INFORMATION

TYPE NUMBER	PACKAGE		
	NAME	DESCRIPTION	VERSION
TDA4860	SIL9MPF	plastic single in-line medium power package with fin; 9 leads	SOT110-1

# Vertical deflection power amplifier for monitors

TDA4860

## BLOCK DIAGRAM

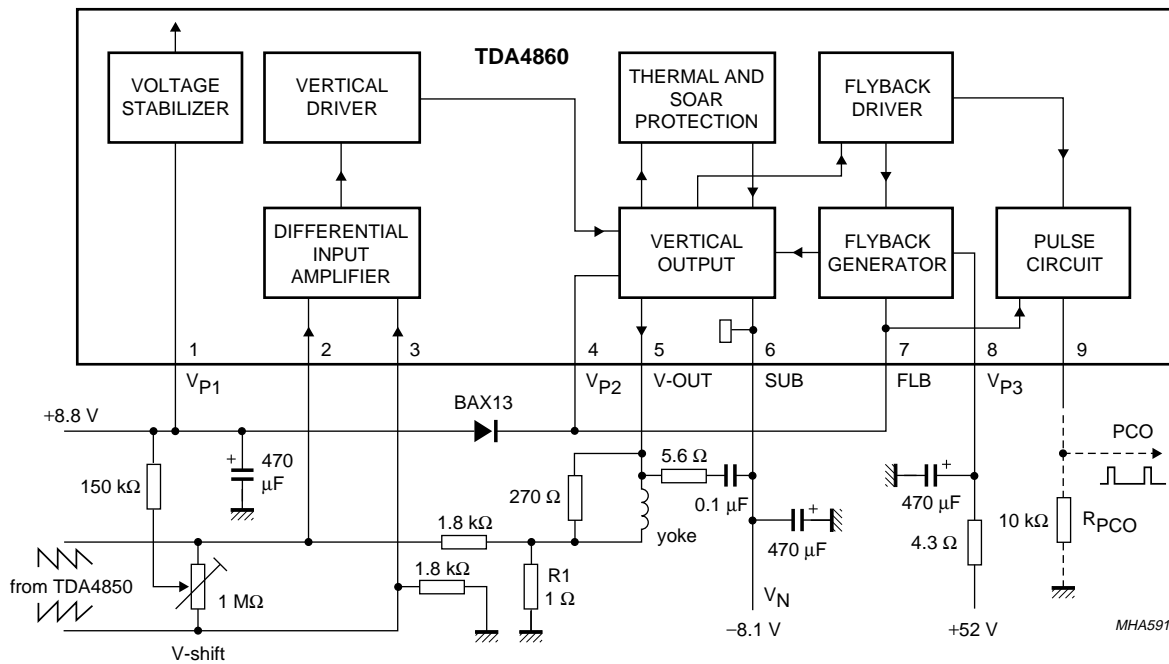

**Assumed values:**

- $I_{yoke} = 1.42 \text{ A.}$
- $R_{yoke} = 4.17 \Omega + 7\% + \Delta R(T) = 6.12 \Omega.$
- $L_{yoke} = 5.25 \text{ mH.}$
- $R_1 = 1.0 \Omega \pm 1\%.$
- $T_{amb} = 65 \text{ }^\circ\text{C.}$
- $T_{j(max)} = 105 \text{ }^\circ\text{C.}$
- $T_{yoke} = 75 \text{ }^\circ\text{C.}$
- $P_{yoke} = 1.2 \text{ W.}$
- $P_{IC} = 1.8 \text{ W.}$
- $P_{tot} = 3.0 \text{ W.}$
- $t_{p\_FLB} = \text{typically } 250 \mu\text{s.}$

**Attention:** the heatsink of the IC must be isolated against ground; the cooling fin is connected to pin 6.

Fig.1 Block diagram and application circuit with flyback supply voltage  $V_{P3}$  from an external source. Deflection frequency range from 50 Hz to 100 Hz.

# Vertical deflection power amplifier for monitors

TDA4860

## PINNING

SYMBOL	PIN	DESCRIPTION
V <sub>P1</sub>	1	supply voltage 1
INP1	2	input 1 of differential input amplifier
INP2	3	input 2 of differential input amplifier
V <sub>P2</sub>	4	supply voltage 2 for vertical output stage
V-OUT	5	vertical output
SUB	6	substrate
FLB	7	flyback generator output
V <sub>P3</sub>	8	flyback supply voltage 3
PCO	9	pulse circuit output

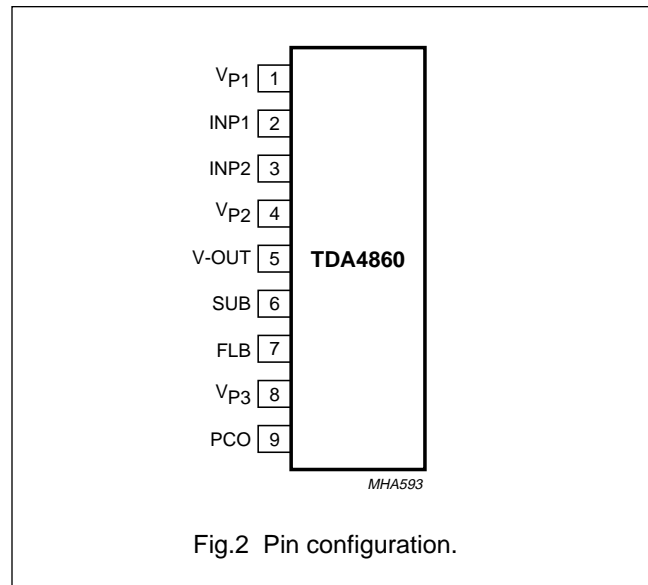

## FUNCTIONAL DESCRIPTION

### Differential input amplifier

The differential sawtooth input signal (coming from a ramp output of the TDA4850 for example) is fed to the input pins 2 and 3. The non-inverted signal is attached to pin 3. The vertical feedback signal is superimposed on the inverted input signal on pin 2.

Vertical shift is applied at the inputs in a power-less way (see Fig.1).

### Flyback generator

Signals for the flyback generator and the pulse circuit are generated in the flyback driver stage. The flyback output consists of a Darlington transistor and a flyback diode. The flyback generator can operate in two modes:

1. An external supply voltage is applied for the short flyback time, thus the power dissipation is minimum (see Fig.1).
2. The flyback voltage is generated by doubling the supply voltage (see Fig.5). The 100  $\mu$ F capacitor C2 between pins 4 and 7 is charged up to V<sub>P1</sub> during scan, using the external diode and the resistor R2. The cathode of the capacitor C2 is connected to the positive rail during flyback. Thus, the flyback voltage is twice the supply voltage.

### Vertical output

The vertical output stage is a quasi-complementary class-B amplifier with a high linearity. The output contains SOAR (short-circuit protection) and thermal protection. The output current on pin 5 is reduced for a short time (to let the temperature decrease to  $T_j < 150$  °C), when the junction temperature ( $T_j$ ) exceeds 160 °C.

### Deflection GUARD

Pin 9 will go HIGH if the junction temperature goes to high (see Fig.3). A pulse signal with 50% duty cycle is output on pin 9, if the deflection coil is open-circuit. A flyback pulse signal is output at normal conditions.

Further watching can be achieved by means of an external GUARD circuit as shown in Fig.4. The 22  $\mu$ F capacitor is charged during flyback time ( $V_5 > V_8$ ) at normal conditions. In case of failures, the capacitor is discharged and the GUARD output goes HIGH.

GUARD output level (see Fig.4):

- LOW for normal conditions
- HIGH for deflection coil short-circuit respectively open-circuit
- HIGH when there are neither input or output signals.

# Vertical deflection power amplifier for monitors

TDA4860

## LIMITING VALUES

In accordance with the Absolute Maximum Rating System (IEC 134); voltages referenced to substrate (pin 6); unless otherwise specified.

SYMBOL	PARAMETER	CONDITIONS	MIN.	MAX.	UNIT
V <sub>P1</sub>	supply voltage (pin 1)		–	40	V
V <sub>P2</sub>	supply voltage (pin 4)		–	60	V
V <sub>P3</sub>	supply voltage (pin 8)		–	60	V
V <sub>2,3,9</sub>	voltage on pins 2, 3 and 9		–	V <sub>P1</sub>	V
V <sub>5,7</sub>	voltage on pins 5 and 7		–	60	V
I <sub>4</sub>	current on pin 4		–	1	A
I <sub>5 (M)</sub>	output current on pin 5 (peak value)	note 1	–	±1.3	A
I <sub>7 (M)</sub>	flyback current on pin 7 (peak value)		–	±1.3	A
I <sub>9</sub>	current on pin 9		–	–8	mA
T <sub>stg</sub>	storage temperature		–25	+150	°C
T <sub>amb</sub>	operating ambient temperature		–20	+75	°C
T <sub>j</sub>	junction temperature	note 1	–	168	°C
V <sub>es</sub>	electrostatic handling for all pins	note 2	–	±300	V

### Notes

- Internally limited by thermal protection; switching temperature point at 160 ±8 °C.
- Equivalent to discharging a 200 pF capacitor through a 0 Ω series resistor.

## THERMAL CHARACTERISTICS

SYMBOL	PARAMETER	VALUE	UNIT
R <sub>th j-c</sub>	thermal resistance from junction to case	10	K/W

The heatsink can be estimated according to application circuit (see Fig.1):

$$R_{th j-a} = R_{th j-c} + R_{th c-h} + R_{th h-a} = \frac{T_{j(max)} - T_{amb}}{P_{IC(max)}} = \frac{105\text{ °C} - 65\text{ °C}}{1.8\text{ W}} = 22.2\text{ K/W}.$$

A heatsink is needed at R<sub>th j-c</sub> < 10 K/W and R<sub>th c-h</sub> = 0.5 K/W (using silicon grease) with R<sub>th h-a</sub> = 22.2 K/W – (10 + 0.5) K/W = 11.7 K/W.

# Vertical deflection power amplifier for monitors

TDA4860

## CHARACTERISTICS

$V_{P1} = V_{P2} = 25 \text{ V}$ ;  $V_N = V_6 = 0 \text{ V}$ ;  $T_{\text{amb}} = 25 \text{ }^\circ\text{C}$ ; voltages referenced to substrate (pin 6); unless otherwise specified.

SYMBOL	PARAMETER	CONDITIONS	MIN.	TYP.	MAX.	UNIT
$V_{P1}$	supply voltage 1 (pin 1)		9	25	30	V
$V_{P2}$	supply voltage 2 (pin 4)		9	25	60	V
$V_{P3}$	supply voltage 3 (pin 8)		9	–	60	V
$I_{P1}$	supply current (pin 1)		–	–	10	mA
$I_{P2}$	quiescent supply current (pin 4)	without input signal	–	9	–	mA
<b>Pre-amplifier</b>						
$V_{2,3}$	input voltage (pins 2 and 3)		1.6	–	$V_{P1} - 0.5$	V
$I_{2,3}$	input quiescent current	without input signal	–	100	–	nA
<b>Flyback generator</b>						
$V_7$	output voltage	upper value; $I_7 = -1 \text{ A}$	–	$V_{P3} - 2.2$	–	V
$I_{7(M)}$	flyback output current (maximum value; pin 7)		–	–	$\pm 1$	A
$V_{1-5}$	threshold voltage to switch flyback	on/off threshold	–	1.4	–	V
$t_{p \text{ FLB}}$	flyback pulse time	see Figs 1 and 3	–	250	–	$\mu\text{s}$
<b>Vertical output; see Fig.3</b>						
$V_5$	output voltage	upper value; $I_5 = -1 \text{ A}$	$V_{P2} - 2.3$	$V_{P2} - 2$	–	V
		lower value; $I_5 = 1 \text{ A}$	–	1.5	1.7	V
$I_{5(M)}$	vertical output current (maximum value; pin 5)		–	–	$\pm 1$	A
LIN	non-linearity of output signal		–	–	1	%
<b>Pulse circuit output; see Fig.3</b>						
$V_9$	output voltage	$R_{PCO} = 10 \text{ k}\Omega$ ; see Fig.1	0.4	–	$V_{P1} - 0.4$	V
$V_9$	output voltage for thermal protection active		$V_{P1} - 0.4$	–	–	V
$V_{1-5}$	voltage to insert flyback pulse on pin 9	normal condition	–	–	1.4	V
$t_{p9}$	pulse width	deflection open-circuit	–	50	–	%
		normal condition	$t_{p \text{ FLB}}$	–	–	$\mu\text{s}$

# Vertical deflection power amplifier for monitors

## TDA4860

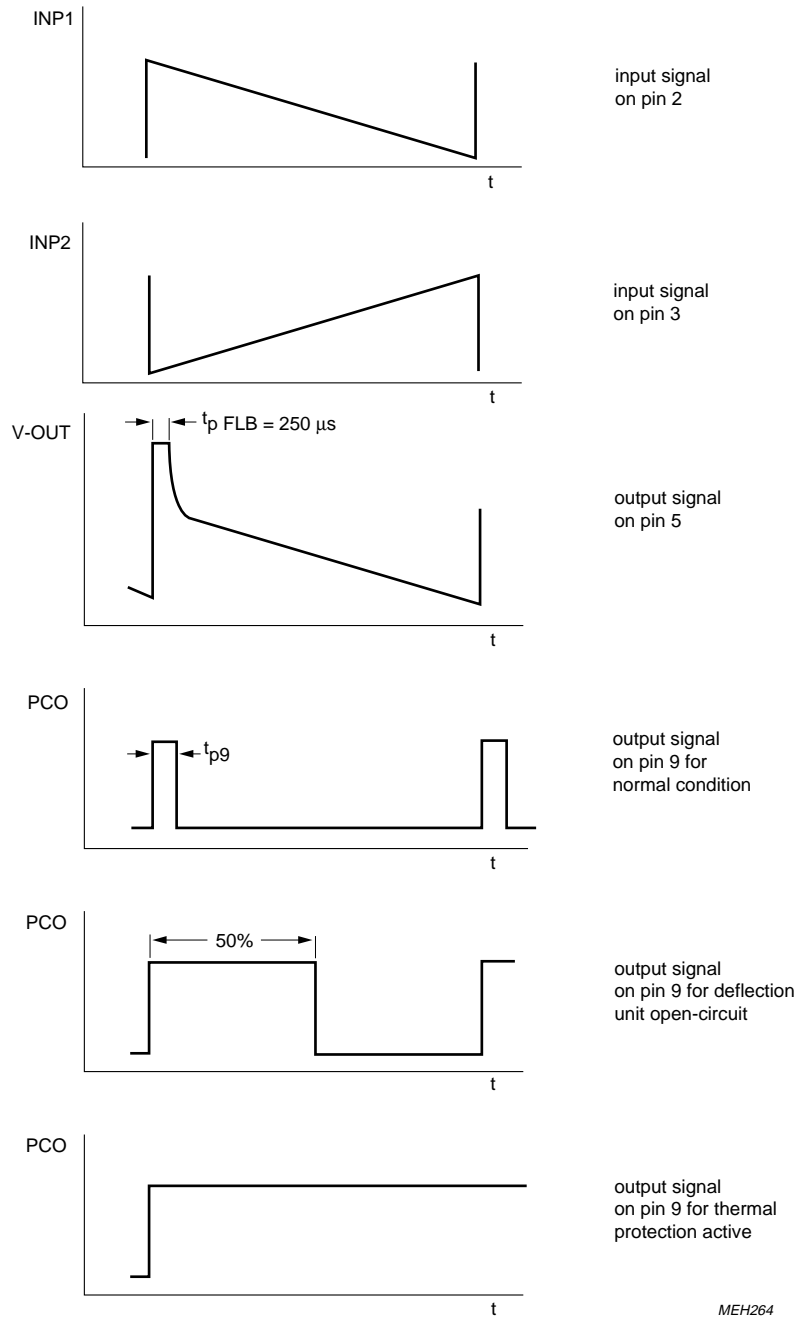
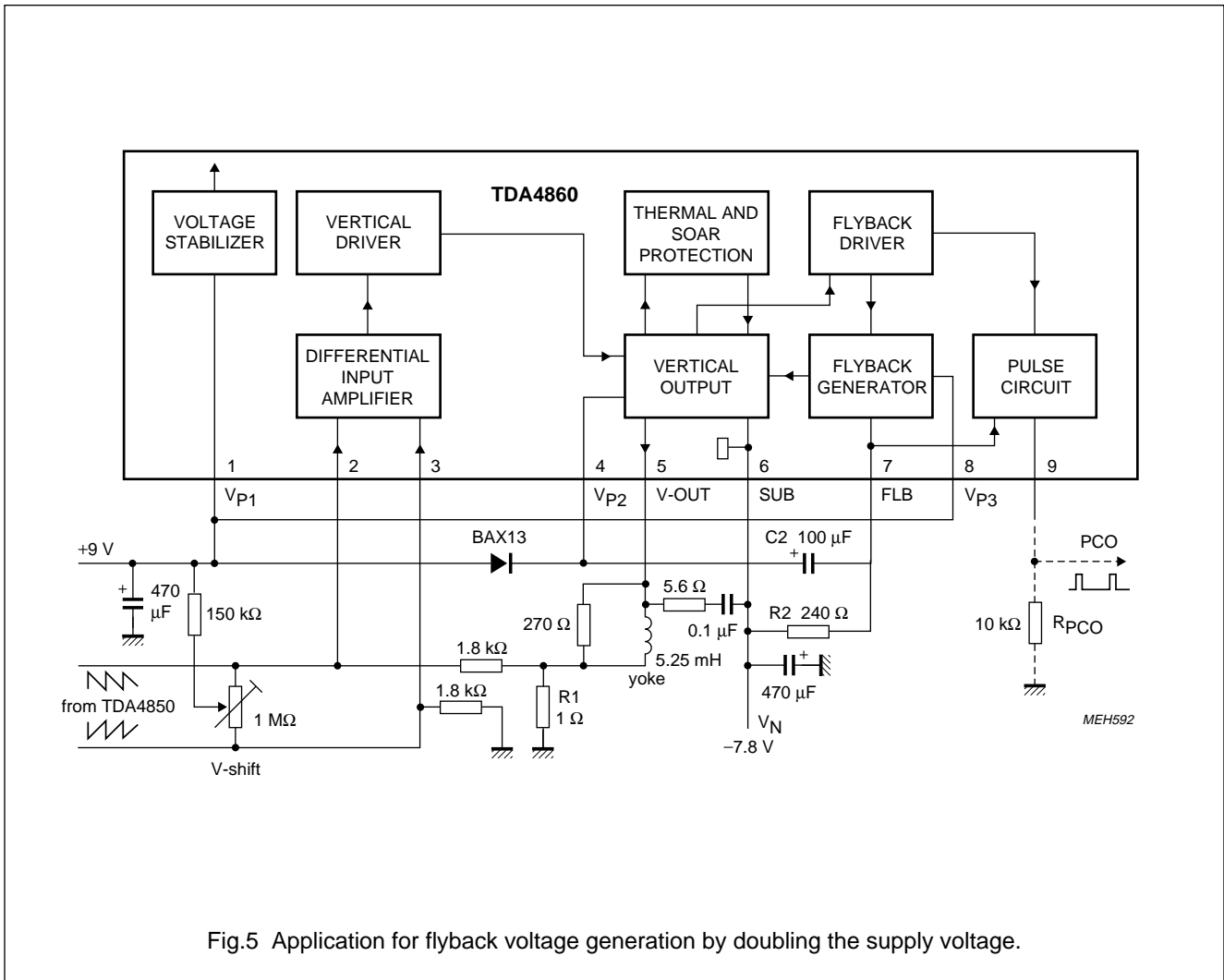
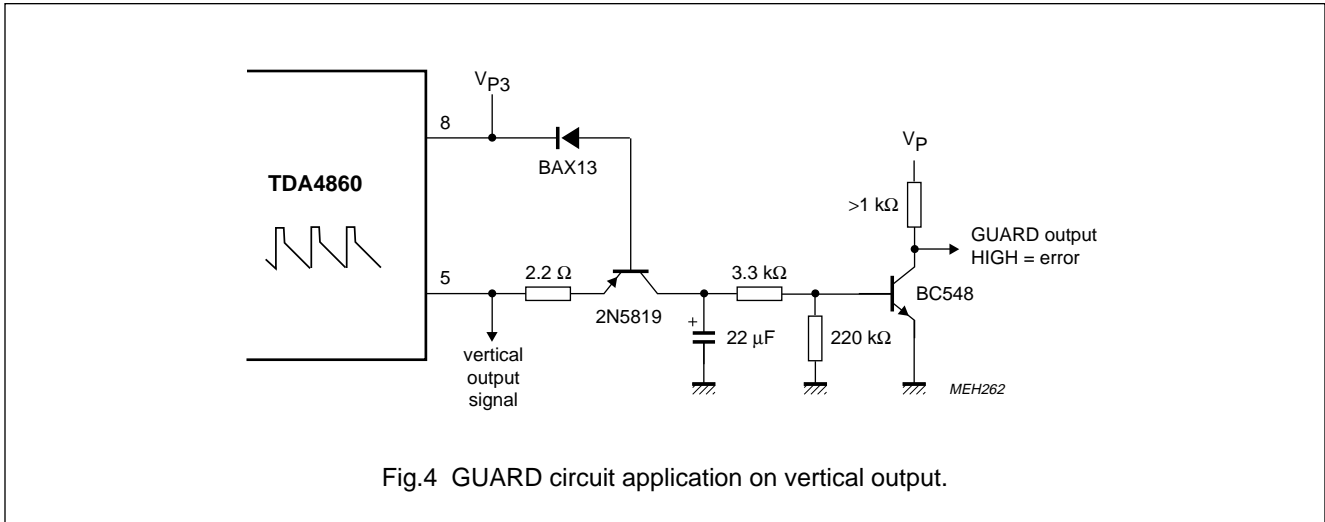

Fig.3 Vertical timing.

# Vertical deflection power amplifier for monitors

TDA4860

## APPLICATION INFORMATION





# Vertical deflection power amplifier for monitors

## TDA4860

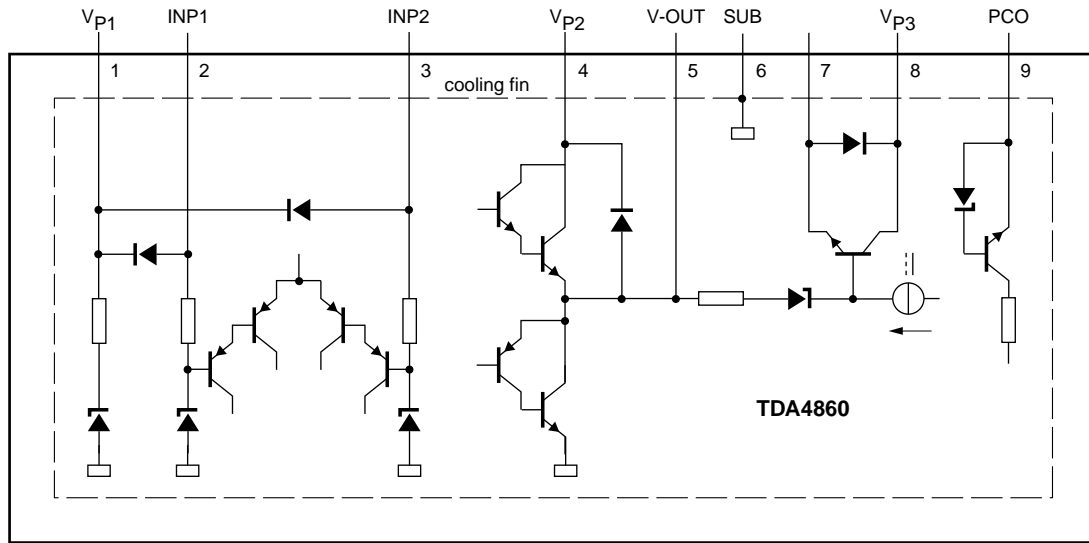

MEH266

Fig.6 Internal circuitry.



# Vertical deflection power amplifier for monitors

TDA4860

## SOLDERING

### Introduction

There is no soldering method that is ideal for all IC packages. Wave soldering is often preferred when through-hole and surface mounted components are mixed on one printed-circuit board. However, wave soldering is not always suitable for surface mounted ICs, or for printed-circuits with high population densities. In these situations reflow soldering is often used.

This text gives a very brief insight to a complex technology. A more in-depth account of soldering ICs can be found in our "IC Package Databook" (order code 9398 652 90011).

### Soldering by dipping or by wave

The maximum permissible temperature of the solder is 260 °C; solder at this temperature must not be in contact with the joint for more than 5 seconds. The total contact time of successive solder waves must not exceed 5 seconds.

The device may be mounted up to the seating plane, but the temperature of the plastic body must not exceed the specified maximum storage temperature ( $T_{stg\ max}$ ). If the printed-circuit board has been pre-heated, forced cooling may be necessary immediately after soldering to keep the temperature within the permissible limit.

### Repairing soldered joints

Apply a low voltage soldering iron (less than 24 V) to the lead(s) of the package, below the seating plane or not more than 2 mm above it. If the temperature of the soldering iron bit is less than 300 °C it may remain in contact for up to 10 seconds. If the bit temperature is between 300 and 400 °C, contact may be up to 5 seconds.

## DEFINITIONS

Data sheet status	
Objective specification	This data sheet contains target or goal specifications for product development.
Preliminary specification	This data sheet contains preliminary data; supplementary data may be published later.
Product specification	This data sheet contains final product specifications.
Limiting values	
Limiting values given are in accordance with the Absolute Maximum Rating System (IEC 134). Stress above one or more of the limiting values may cause permanent damage to the device. These are stress ratings only and operation of the device at these or at any other conditions above those given in the Characteristics sections of the specification is not implied. Exposure to limiting values for extended periods may affect device reliability.	
Application information	
Where application information is given, it is advisory and does not form part of the specification.	

## LIFE SUPPORT APPLICATIONS

These products are not designed for use in life support appliances, devices, or systems where malfunction of these products can reasonably be expected to result in personal injury. Philips customers using or selling these products for use in such applications do so at their own risk and agree to fully indemnify Philips for any damages resulting from such improper use or sale.

# Philips Semiconductors – a worldwide company

**Argentina:** see South America

**Australia:** 34 Waterloo Road, NORTH RYDE, NSW 2113,  
Tel. +61 2 9805 4455, Fax. +61 2 9805 4466

**Austria:** Computerstr. 6, A-1101 WIEN, P.O. Box 213,  
Tel. +43 1 60 101, Fax. +43 1 60 101 1210

**Belarus:** Hotel Minsk Business Center, Bld. 3, r. 1211, Volodarski Str. 6,  
220050 MINSK, Tel. +375 172 200 733, Fax. +375 172 200 773

**Belgium:** see The Netherlands

**Brazil:** see South America

**Bulgaria:** Philips Bulgaria Ltd., Energoproject, 15th floor,  
51 James Bourchier Blvd., 1407 SOFIA,  
Tel. +359 2 689 211, Fax. +359 2 689 102

**Canada:** PHILIPS SEMICONDUCTORS/COMPONENTS,  
Tel. +1 800 234 7381

**China/Hong Kong:** 501 Hong Kong Industrial Technology Centre,  
72 Tat Chee Avenue, Kowloon Tong, HONG KONG,  
Tel. +852 2319 7888, Fax. +852 2319 7700

**Colombia:** see South America

**Czech Republic:** see Austria

**Denmark:** Prags Boulevard 80, PB 1919, DK-2300 COPENHAGEN S,  
Tel. +45 32 88 2636, Fax. +45 31 57 1949

**Finland:** Sinikalliontie 3, FIN-02630 ESPOO,  
Tel. +358 9 615800, Fax. +358 9 61580/xxx

**France:** 4 Rue du Port-aux-Vins, BP317, 92156 SURESNES Cedex,  
Tel. +33 1 40 99 6161, Fax. +33 1 40 99 6427

**Germany:** Hammerbrookstraße 69, D-20097 HAMBURG,  
Tel. +49 40 23 53 60, Fax. +49 40 23 536 300

**Greece:** No. 15, 25th March Street, GR 17778 TAVROS/ATHENS,  
Tel. +30 1 4894 339/239, Fax. +30 1 4814 240

**Hungary:** see Austria

**India:** Philips INDIA Ltd, Shivsagar Estate, A Block, Dr. Annie Besant Rd.  
Worli, MUMBAI 400 018, Tel. +91 22 4938 541, Fax. +91 22 4938 722

**Indonesia:** see Singapore

**Ireland:** Newstead, Clonskeagh, DUBLIN 14,  
Tel. +353 1 7640 000, Fax. +353 1 7640 200

**Israel:** RAPAC Electronics, 7 Kehilat Saloniki St, TEL AVIV 61180,  
Tel. +972 3 645 0444, Fax. +972 3 649 1007

**Italy:** PHILIPS SEMICONDUCTORS, Piazza IV Novembre 3,  
20124 MILANO, Tel. +39 2 6752 2531, Fax. +39 2 6752 2557

**Japan:** Philips Bldg 13-37, Kohnan 2-chome, Minato-ku, TOKYO 108,  
Tel. +81 3 3740 5130, Fax. +81 3 3740 5077

**Korea:** Philips House, 260-199 Itaewon-dong, Yongsan-ku, SEOUL,  
Tel. +82 2 709 1412, Fax. +82 2 709 1415

**Malaysia:** No. 76 Jalan Universiti, 46200 PETALING JAYA, SELANGOR,  
Tel. +60 3 750 5214, Fax. +60 3 757 4880

**Mexico:** 5900 Gateway East, Suite 200, EL PASO, TEXAS 79905,  
Tel. +9-5 800 234 7381

**Middle East:** see Italy

**Netherlands:** Postbus 90050, 5600 PB EINDHOVEN, Bldg. VB,  
Tel. +31 40 27 82785, Fax. +31 40 27 88399

**New Zealand:** 2 Wagener Place, C.P.O. Box 1041, AUCKLAND,  
Tel. +64 9 849 4160, Fax. +64 9 849 7811

**Norway:** Box 1, Manglerud 0612, OSLO,  
Tel. +47 22 74 8000, Fax. +47 22 74 8341

**Philippines:** Philips Semiconductors Philippines Inc.,  
106 Valero St. Salcedo Village, P.O. Box 2108 MCC, MAKATI,  
Metro MANILA, Tel. +63 2 816 6380, Fax. +63 2 817 3474

**Poland:** Ul. Lukiska 10, PL 04-123 WARSZAWA,  
Tel. +48 22 612 2831, Fax. +48 22 612 2327

**Portugal:** see Spain

**Romania:** see Italy

**Russia:** Philips Russia, Ul. Usatcheva 35A, 119048 MOSCOW,  
Tel. +7 095 247 9145, Fax. +7 095 247 9144

**Singapore:** Lorong 1, Toa Payoh, SINGAPORE 1231,  
Tel. +65 350 2538, Fax. +65 251 6500

**Slovakia:** see Austria

**Slovenia:** see Italy

**South Africa:** S.A. PHILIPS Pty Ltd., 195-215 Main Road Martindale,  
2092 JOHANNESBURG, P.O. Box 7430 Johannesburg 2000,  
Tel. +27 11 470 5911, Fax. +27 11 470 5494

**South America:** Rua do Rocio 220, 5th floor, Suite 51,  
04552-903 São Paulo, SÃO PAULO - SP, Brazil,  
Tel. +55 11 821 2333, Fax. +55 11 829 1849

**Spain:** Balmes 22, 08007 BARCELONA,  
Tel. +34 3 301 6312, Fax. +34 3 301 4107

**Sweden:** Kottbygatan 7, Akalla, S-16485 STOCKHOLM,  
Tel. +46 8 632 2000, Fax. +46 8 632 2745

**Switzerland:** Allmendstrasse 140, CH-8027 ZÜRICH,  
Tel. +41 1 488 2686, Fax. +41 1 481 7730

**Taiwan:** PHILIPS TAIWAN Ltd., 23-30F, 66,  
Chung Hsiao West Road, Sec. 1, P.O. Box 22978,  
TAIPEI 100, Tel. +886 2 382 4443, Fax. +886 2 382 4444

**Thailand:** PHILIPS ELECTRONICS (THAILAND) Ltd.,  
209/2 Sanpavuth-Bangna Road Prakanong, BANGKOK 10260,  
Tel. +66 2 745 4090, Fax. +66 2 398 0793

**Turkey:** Talatpasa Cad. No. 5, 80640 GÜLTEPE/ISTANBUL,  
Tel. +90 212 279 2770, Fax. +90 212 282 6707

**Ukraine:** PHILIPS UKRAINE, 4 Patrice Lumumba str., Building B, Floor 7,  
252042 KIEV, Tel. +380 44 264 2776, Fax. +380 44 268 0461

**United Kingdom:** Philips Semiconductors Ltd., 276 Bath Road, Hayes,  
MIDDLESEX UB3 5BX, Tel. +44 181 730 5000, Fax. +44 181 754 8421

**United States:** 811 East Arques Avenue, SUNNYVALE, CA 94088-3409,  
Tel. +1 800 234 7381

**Uruguay:** see South America

**Vietnam:** see Singapore

**Yugoslavia:** PHILIPS, Trg N. Pasica 5/v, 11000 BEOGRAD,  
Tel. +381 11 625 344, Fax. +381 11 635 777

**For all other countries apply to:** Philips Semiconductors, Marketing & Sales Communications,  
Building BE-p, P.O. Box 218, 5600 MD EINDHOVEN, The Netherlands, Fax. +31 40 27 24825

**Internet:** <http://www.semiconductors.philips.com>

© Philips Electronics N.V. 1996

SCA52

All rights are reserved. Reproduction in whole or in part is prohibited without the prior written consent of the copyright owner.

The information presented in this document does not form part of any quotation or contract, is believed to be accurate and reliable and may be changed without notice. No liability will be accepted by the publisher for any consequence of its use. Publication thereof does not convey nor imply any license under patent- or other industrial or intellectual property rights.

Printed in The Netherlands

537021/1200/02/pp12

Date of release: 1996 Nov 26

Document order number: 9397 750 01419

*Let's make things better.*

**Philips  
Semiconductors**



**PHILIPS**