

FEATURES

- Glass Passivated Die Construction
- Super-Fast Recovery Time For High Efficiency
- Low Forward Voltage Drop and High Current Capability
- Ideally Suited for Automated Assembly
- Plastic Material: UL Flammability Classification Rating 94V-0



SMAF

MECHANICAL DATA

- Case: SMAF Molded plastic
- Terminals: Pure tin plated, lead free
- Polarity: Indicated by cathode band
- Weight: 27mg (approx.)

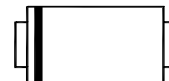

Cathode

MAXIMUM RATINGS AND ELECTRICAL CHARACTERISTICS

Ratings at 25 °C ambient temperature unless otherwise specified. Single phase, half wave, 60 Hz, resistive or inductive load. For capacitive load, derate current by 20%.

Parameter	Symbol	US1AF	US1BF	US1DF	US1GF	US1JF	US1KF	US1MF	Unit
Maximum Repetitive Peak Reverse Voltage	V_{RRM}	50	100	200	400	600	800	1000	V
Maximum RMS Voltage	V_{RMS}	35	70	140	280	420	560	700	V
Maximum DC Blocking Voltage	V_{DC}	50	100	200	400	600	800	1000	V
Maximum Average Forward Rectified Current at $T_A = 75\text{ °C}$	$I_{F(AV)}$	1.0							A
Peak Forward Surge Current 8.3ms Single Half Sine-wave Superimposed on Rated Load (JEDEC)	I_{FSM}	30.0							A
Maximum Instantaneous Forward Voltage at 1 A	V_F	1.0		1.4		1.7		V	
Maximum DC Reverse Current at Rated DC Blocking Voltage	I_R			5.0		50.0		μA	
Maximum reverse recovery time (NOTE1)	t_{rr}	50			75			nS	
Typical Junction Capacitance (NOTE2)	C_J	15.0							pF
Maximum Thermal Resistance (NOTE3)	$R_{\theta JL}$	50.0							°C/W
Operating and Storage Temperature Range	$T_{J, TS}$	-50 to + 150							°C

Note: 1.Reverse recovery condition $I_F=0.5A, I_R=1.0A, I_{rr}=0.25A$

2.Measured at 1MHz and applied reverse voltage of 4.0V D.C.

3.P.C.B. mounted with 0.2x0.2"(5.0x5.0mm) copper pad areas

Typical Characteristics

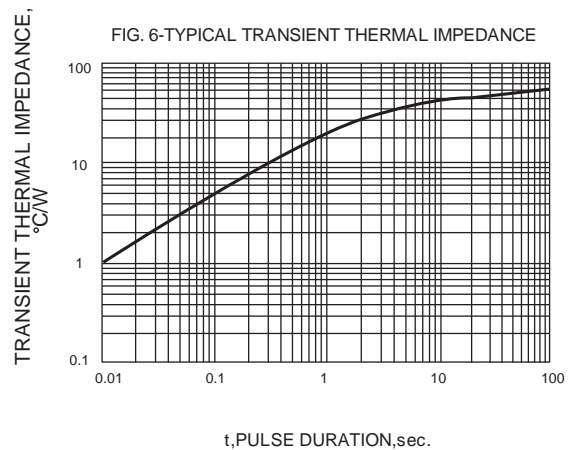
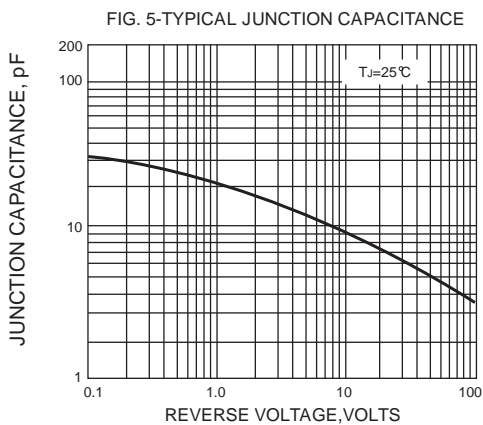
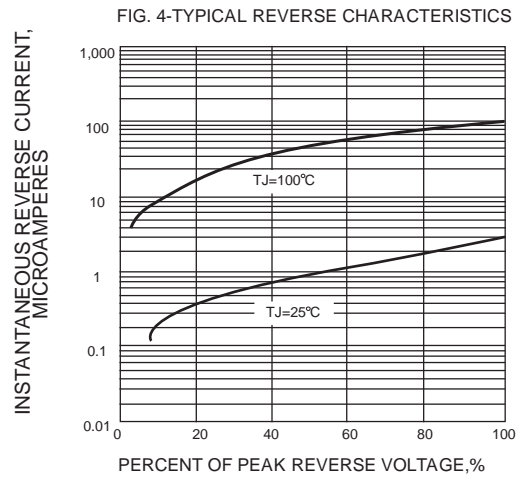
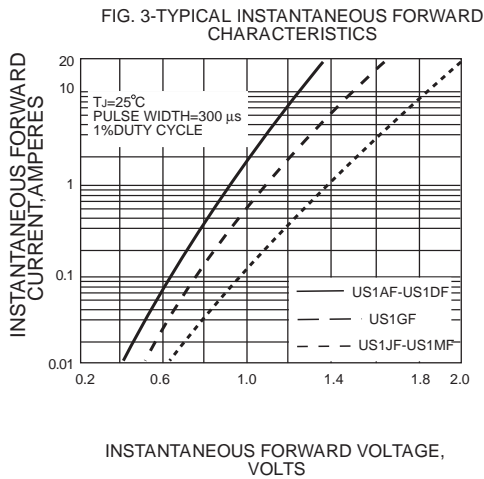
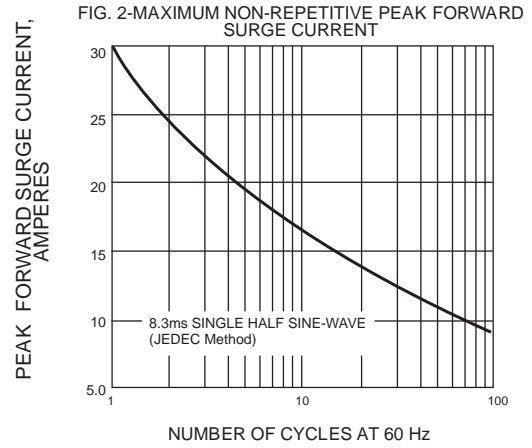
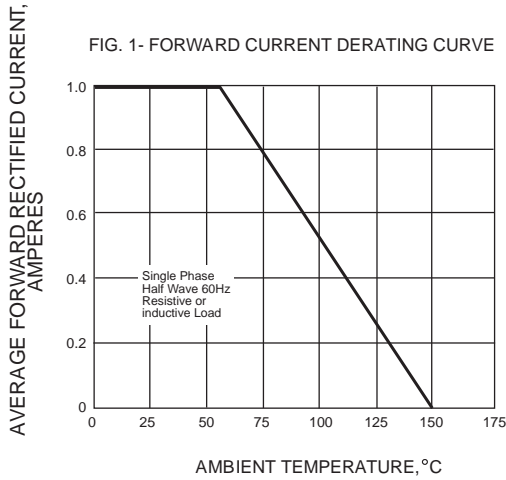

SMAF Package Outline Dimensions

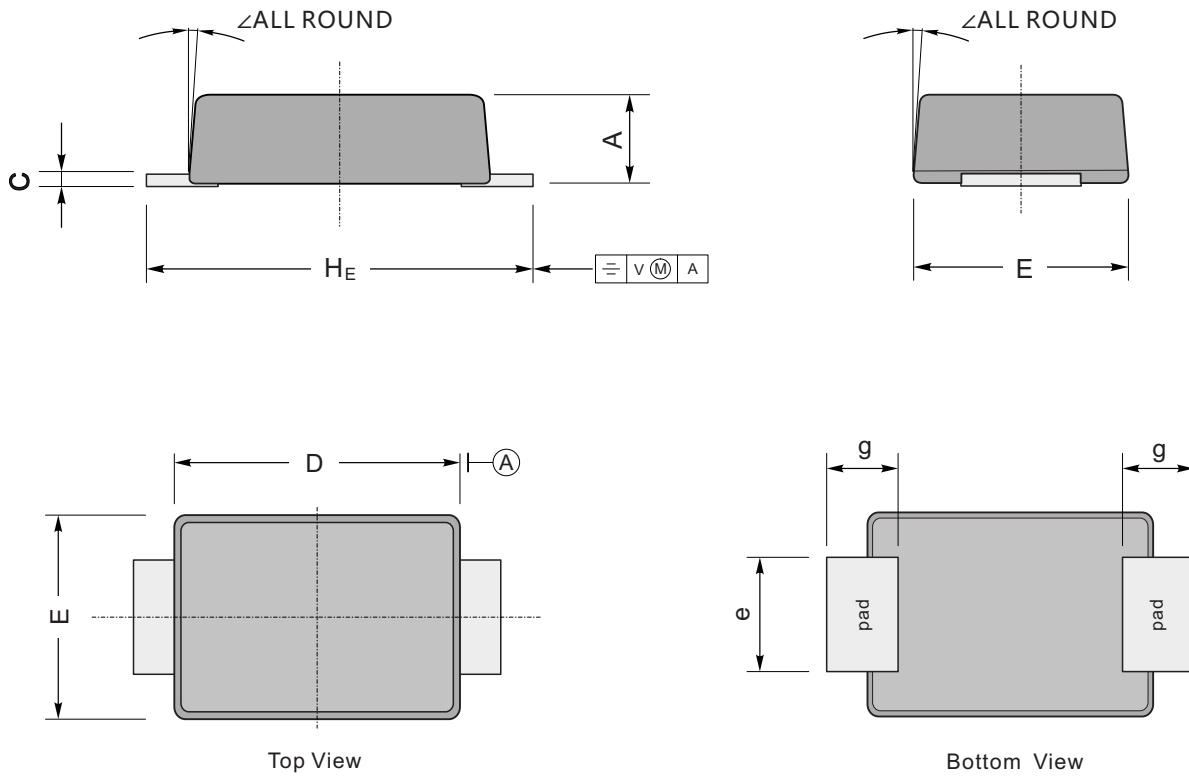

UNIT		A	C	D	E	e	g	HE	∠
mm	max	1.1	0.20	3.7	2.7	1.6	1.2	4.9	7°
	min	0.9	0.12	3.3	2.4	1.3	0.8	4.4	
mil	max	43	7.9	146	106	63	47	193	
	min	35	4.7	130	94	51	31	173	