

## Data sheet

Commercial Art.No.: 46.052.4553.9

Connector RST16i5 S S1 ZT6S H BL

RST16i5 connector, 5 pole, male, screw connection, application 250/400V, 16A, for cable diameters 7.1-13mm, coding color light blue, color of housing black



Commercial Art.No.	46.052.4553.9
EAN	4049088269240
Order Unit	1

Certificates / Approvals



## Technical data

### General

Rated current	16 A
Rated voltage	250 V / 400 V
Rated impulse voltage	4 kV
strain relief	yes
Pollution degree	3
Lockable	self-locking (unlocking by hand)
Color of coding/ contact carrier	light blue
Marking of poles	1, 2, 3, 4, 5
Color of housing inclusive strain relief	black

### Connection Data

Cable diameter max.	13 mm
Cable diameter min.	7.1 mm
Connection cross section solid mm <sup>2</sup> max.	2.5 mm <sup>2</sup>
Connection cross section solid mm <sup>2</sup> min.	0.25 mm <sup>2</sup>
Connection cross section fine stranded mm <sup>2</sup> max.	2.5 mm <sup>2</sup>
Connection cross section fine stranded mm <sup>2</sup> min.	0.25 mm <sup>2</sup>
Terminations per pole	1
sheath strip length	25 mm
Wire strip length	8 mm

### Model

Model	male
Connection type	screw connection
Degree of protection (IP)	IP66/68 (3m;2h) /IP69

### Material

Housing material	Polyamide
halogen free	yes
Contact material	CuZn
Fire load	0.148 kWh
Insulation components continuous temperature	100 °C
Surface finish	Silver-plated

#### Dimensions

Length	74 mm
Width	24 mm
Height	24 mm

#### Classification

ECLASS 11	
ECLASS 8.1	27440605
ETIM 7.0	EC002560
ETIM 6.0	EC002560
ETIM 5.0	EC002560
ETIM 4.0	EC002560

#### Note

Note	RST® terminals with screw clamping allow the connection of conductors without special preparation (without ferrules) according to EN 60999-1.
------	---

#### Product compliance

ROHS conformity status	Compliant/Exempted
ROHS exceptions	III-6(c)
REACH-SVHC conformity status	Duty-To-Declare
REACH-SVHC substances	Lead
REACH-SVHC CAS numbers	7439-92-1

#### Fits with

Commercial Art.No.:	Article-type description:	Description:
46.051.4553.9	Connector RST16i5 S B1 ZT6S H BL	RST16i5 connector, 5 pole, female, screw connection, application 250/400V, 16A, for cable diameters 7.1-13mm, coding color light blue, color of housing black
46.051.5053.9	Device connector RST16i5 S B1 M03 H BL	RST16i5 device connector M20,2, 5 pole, female, screw connection, application 250/400V, 16A, coding color light blue
46.050.0153.9	Distributor RST16i5B 3P1 F G V BL	RST16i5 compact distribution unit, 5 pole, application 250/400V, 16 A, 1 input and 3 outputs, fastening option, coding color light blue, color of housing black
46.051.M053.9	Device connector RST16i5 B D03H MBL	RST16i5 modular device connector M20, 5 pole, female, spring clamp connection, with automatic wiring option, application 250/400V, 16A, coding color light blue
46.051.M0L0.9	Device connector RST16i5 1 D03H MBL	RST16i5 modular device connector with longitudinal sealing M20, 5 pole, female, spring clamp connection, with automatic wiring option, application 250/400V, 16A, coding color light blue

46.050.1253.9	Distributor RST16I5V 2P1 TGVGA TB	RST16i5 distribution block, 5 pole, application 250/400V, 16 A, 1 input and 2 outputs, fastening option with separate mounting plate, coding color light blue
---------------	-----------------------------------	---

A  
These dimensions will be especially checked at delivery  
Only inspection dimensions  
With /E marked dimensions are only valid for internal use

C  
Diese Maße werden bei Abnahme besonders geprüft  
Ausschließlich Prüfmaße  
Mit /E gekennzeichnete Maße sind nur für interne Zwecke gültig

E  
F

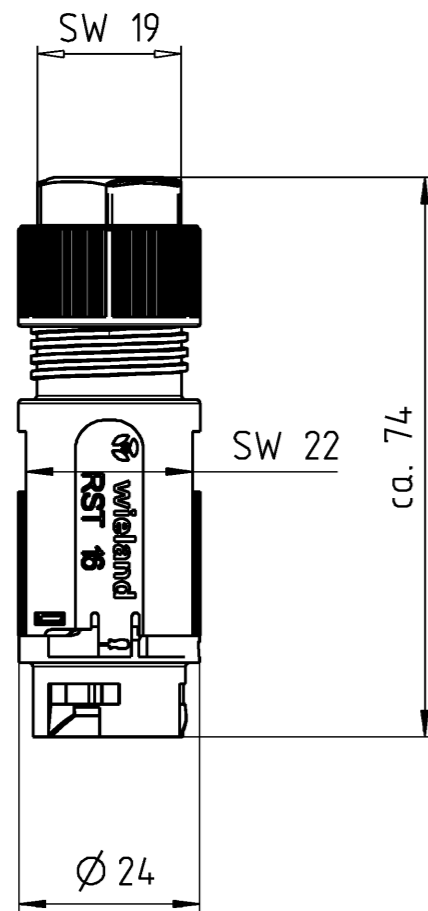

Kodierung/  
coding

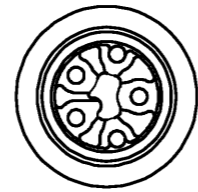

C1

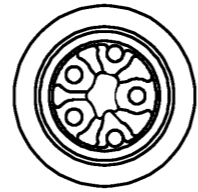

C2

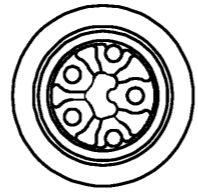

C3

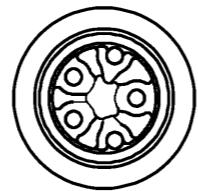

C4

Auslieferungszustand  
delivery condition

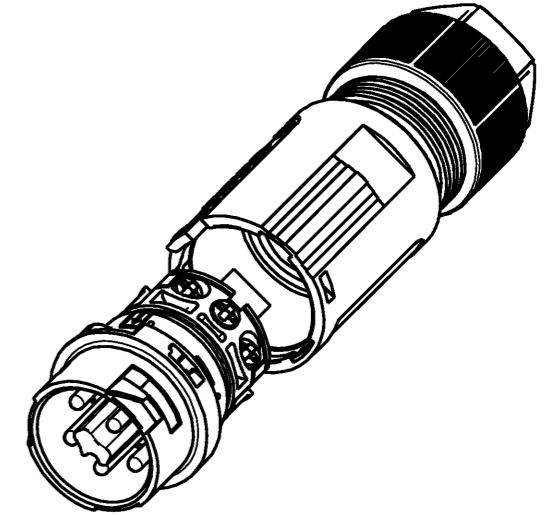
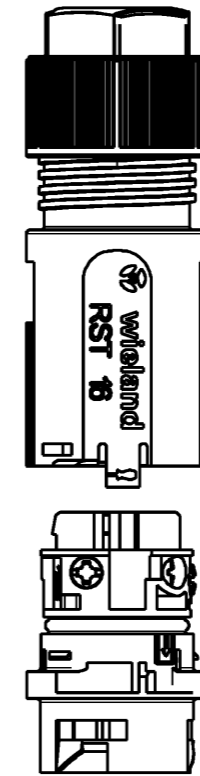

Weitergabe sowie Vervielfältigung dieses Dokuments, Verwertung und Mitteilung seines Inhalts sind verboten, soweit nicht ausdrücklich gestattet. Die Reproduktion, Distribution und Utilization of this document as well as the communication of its contents to others without express authorization is prohibited.

46.052.4553.9	RST16i5 S S1 ZT6S H BL	C4	lichtblau/light blue
46.052.4550.4	RST16i5 S S1 ZT6S L BR	C3	signalbraun/signal brown
46.052.4553.6	RST16i5 S S1 ZT6S A TB	C2	türkisblau/turquoise blue
46.052.4553.1	RST16i5 S S1 ZT6 SW	C1	schwarz/black
46.052.4553.0	RST16i5 S S1 ZT6S GL	C1	lichtgrau/light grey

Bestellnummer/ order number	Typ/type	Kodierung/c oding	Farbe/color
--------------------------------	----------	----------------------	-------------

Tolerierung Size ISO 14405 (E) / Tolerance system Size ISO 14405 (E).  
(This ISO-standard describes the envelope principle. According to the envelope principle the deviations of form and parallelism are limited by the size tolerances).  
ja/yes  Stoffverbots- und Deklarationsliste nach WN 5020.010 ist einzuhalten.  
Conformity with Wieland document WN 5020.010 e (list of prohibited / declarable hazardous substances) to be declared!

Freitoleranz nach General tolerance CAD - Zeichnung, keine manuellen Änderungen CAD - drawing, no manual modifications allowed 1. Verwendung: First Use: Blatt: 1 von 1 Sheet: of 1

Werkstoff / Material	Tag/Date	Name	Zeichnung Nr. / Drawing No.	Index
Maßstab / Scale	gezeichnet/drawn	Treschan		
%	geprüft/checked		T 46.052.4553.013K	a
Vol. --- mm <sup>3</sup>	OfL./Surf. --- mm <sup>2</sup>	Ersatz für / Replacement for:		
Maße in mm / Dimensions are in mm				

a	05.10.2016	<b>wieland</b> www.wieland-electric.com	Type	Benennung/Title
Index	Datum / Blatt Date / Sheet		RST16	Steckerteil
Änderung / Revision			mit Zugentlastung, 5-polig, male connector with strain relief, 5 poles	