

Dept	
Qty	
DC	1
ED	1
IE	1
ISO	1
PD	1
R&D	1
SD	1
QA	1
QC	1
QE	1

The information provided herein is from CONNELY Electronic Co., Ltd. and is confidential. Any disclosure to a party other than the recipient is prohibited. The intellectual properties and its rights contained herein, including but not limited to, trademarks, patents, copyrights, trade secrets, and technical know-how, are owned exclusively by CONNELY or its affiliates. Unauthorized use or reproduction of any part of this document without the prior written permission of CONNELY may result in legal action. CONNELY may enforce its intellectual property rights at its own discretion, failures or delays to exercise such rights does not constitute a waiver of such rights.

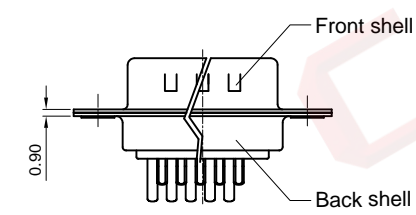
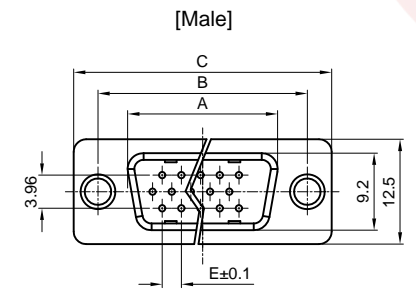
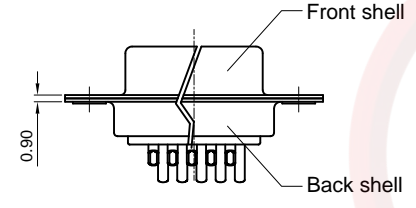
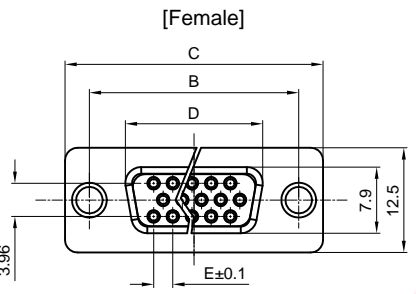

(Series Image-Reference Only)

Dimension

Position	A±0.2	B±0.2	C±0.3	D	E
15	17.90	24.99	30.80	16.33	2.29
26	26.50	33.32	39.14	24.66	2.29
44	40.00	47.04	53.04	38.38	2.29
62	56.50	63.50	69.32	54.84	2.14
78	54.30	61.00	67.04	52.34	2.14

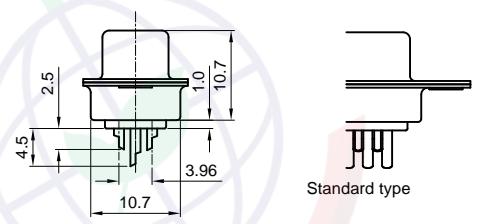

Standard type

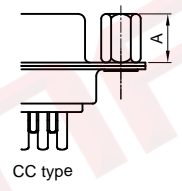

CC type

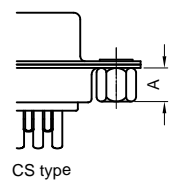

CS type

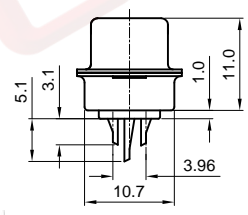

REV.	DESCRIPTION	DRAWN	CHECKED	APPROVED
A	NEW RELEASE	LJH 09/26/05'	~	LJC 09/26/05'
B	整理图画	YCH 05/26/07'	~	LJC 05/26/07'
C	增加锁螺丝类型	YCH 06/30/07'	~	LJC 06/30/07'
D	DRAWING UPDATE	JLZ 08/08/18'	~	

NOTES:

- Electrical characteristics:
  - Contact resistance: 20mΩ Max. Initial.
  - Dielectric withstanding voltage: 500V AC(rms) for 1 minute.
  - Insulation resistance: 1000MΩ Min.
- Environment characteristics:
  - Temperature range: -40°C~+105°C.
- Materials
  - Insulator: Thermoplastic.
  - Contact: Copper alloy.
  - Shell: Steel.
  - Screw: Copper alloy.

4. Product number code:

DS1035- X X X X X X X X

- Screw DIM. A
  - S: Standard(W/O nut)
  - 1: 3.00
  - 2: 4.00
  - 3: 4.50
  - 4: 5.00
  - 5: 5.50
  - 6: 5.80
- Screw type
  - S: Standard(W/O nut)
  - 1: CC type
  - 2: CS type
- Contact plating
  - 8: Full gold flash
  - 8r: Selective gold flash
- Shell plating
  - T: Fornt & Back shell tin
  - N: Fornt shell nickel, Back shell tin
- Housing color
  - B: Black
  - W: White
  - U: Blue
- Connector type
  - M: Male
  - F: Female
- No. of contacts
  - 15: 15pos. 26: 26pos.
  - 44: 44pos. 62: 62pos.

GENERAL TOLERANCE		ANGLE TOLERANCE		PROJECTION	⊕	TITLE	D-SUB H.D SOLDER TYPE		
X.	±0.60	X.	±5°	UNITS	mm				
.X	±0.38	.X	±3°	SHEET SIZE	A4	SERIES	DS1035 SERIES		
.XX	±0.25	.XX	±2°						
DRAWING TYPE		CUSTOMER							
SCALE		1:1	SHEET	1 OF 1					
DRAWING NO.		C-DS1035-XXXXXXX-D							



**晨翔电子有限公司**  
CONNFLY CONNELY ELECTRONIC CO. LTD

Dept	
Qty	
DC	1
ED	1
IE	1
ISO	1
PD	1
R&D	1
SD	1
QA	1
QC	1
QE	1

The information provided herein is from CONNELY Electronic Co., Ltd. and is confidential. Any disclosure to a party other than the recipient is prohibited. The intellectual properties and its rights contained herein, including but not limited to, trademarks, patents, copyrights, trade secrets, and technical know-how, are owned exclusively by CONNELY or its affiliates. Unauthorized use or reproduction of any part of this document is strictly prohibited. CONNELY may enforce its intellectual property rights at its own discretion, failures or delays to exercise such rights does not constitute a waiver of such rights.

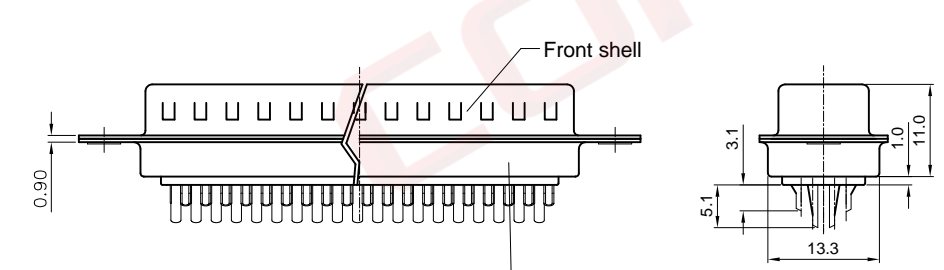
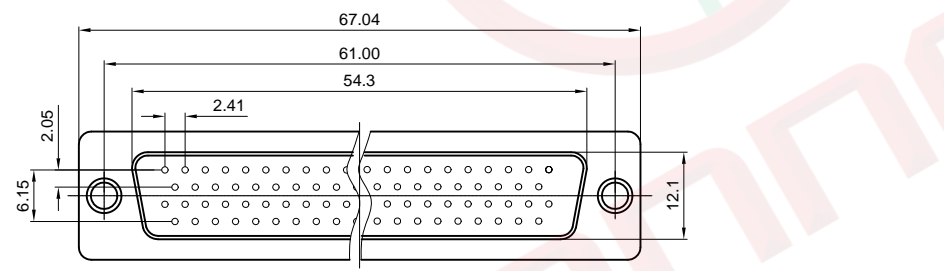
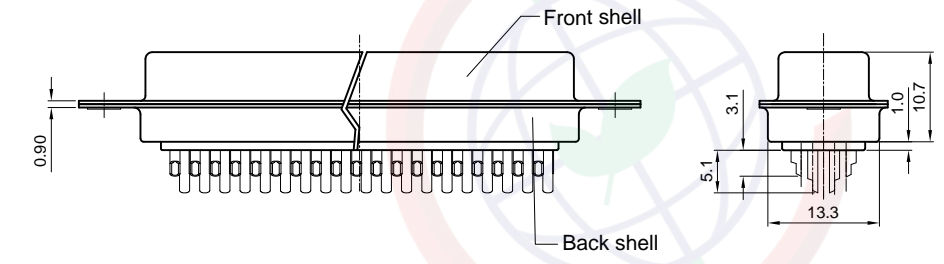
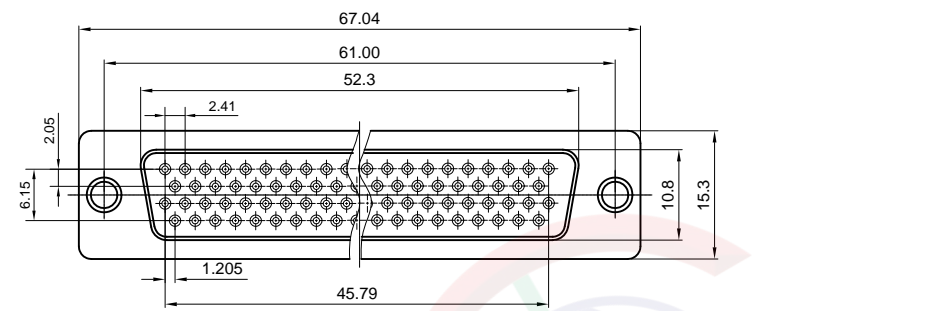

(Series Image-Reference Only)

REV.	DESCRIPTION	DRAWN	CHECKED	APPROVED
A	NEW RELEASE	LL 12/06/06'	~	LJC 12/06/06'
B	增加锁螺丝类型	YCH 06/30/07'	~	LJC 06/30/07'
C	DRAWING UPDATE	JLZ 07/20/17'	HZW 07/20/17'	LJC 07/20/17'
D	DRAWING UPDATE	JLZ 08/08/18'	~	

NOTES:

- Electrical characteristics:
  - Contact resistance: 20mΩ Max. Initial.
  - Dielectric withstanding voltage: 500V AC(rms) for 1 minute.
  - Insulation resistance: 1000MΩ Min.
- Environment characteristics:
  - Temperature range: -40°C~+105°C.
- Materials
  - Insulator: Thermoplastic.
  - Contact: Copper alloy.
  - Shell: Steel.
  - Screw: Copper alloy.

4. Product number code:

DS1035- X X X X X X

- Screw DIM. A
  - S: Standard(W/O nut)
  - 1: 3.00
  - 2: 4.00
  - 3: 4.50
  - 4: 5.00
  - 5: 5.50
  - 6: 5.80
- Screw type
  - S: Standard(W/O nut)
  - 1: CC type
  - 2: CS type
- Contact plating
  - 8: Full gold flash
  - Si: Selective gold flash
- Shell plating
  - T: Fornt & Back shell tin
  - N: Fornt shell nickel,Back shell tin
- Housing color
  - B: Black
  - W: White
  - U: Blue
- Connector type
  - M: Male
  - F: Female
- 78: 78pos  
No. of contacts

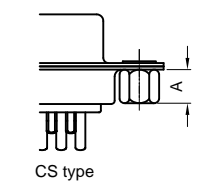
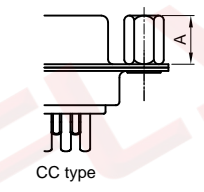
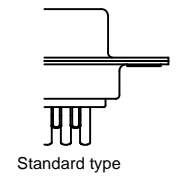

GENERAL TOLERANCE		ANGLE TOLERANCE	
X.	±0.60	X.	±5°
.X	±0.38	.X	±3°
.XX	±0.25	.XX	±2°
DRAWING TYPE		CUSTOMER	
SCALE	1:1	SHEET	1 OF 1
DRAWING NO.	C-DS1035-78XXXXXX-D		

PROJECTION		TITLE	D-SUB H.D SOLDER TYPE	
UNITS	mm	SERIES	DS1035 SERIES	
SHEET SIZE	A4			

晨翔电子有限公司  
CONNFLY CONNFLY ELECTRONIC CO. LTD