

Data sheet

Commercial Art.No.: 25.642.3253.0

PCB pin header 8513 SUFK / 2 OB

PCB pin header with tension spring connection, 2 poles, max. cross section: 1.5 mm², pitch: 3.5 mm, type of packing: carton, color: grey



Commercial Art.No.	25.642.3253.0
EAN	4015573554245
Order Unit	100

Certificates / Approvals



Technical data

General

Modular spacing	3.5 mm
Connection type	spring clamp connection
Soldering process	None
Packaging	Carton
Number of poles	2
Marking	No
Fastening	None
Mating direction towards connector	180°

Technical data

Nominal cross section	1.5 mm ²
Rated current	8 A
Overvoltage Category I	690 V
Overvoltage Category II	250 V
Overvoltage Category III	125
Rated impulse voltage	2.5 kV
Wire strip length	8 mm

Connection Data

Minimum cross section solid	0.14 mm ²
Maximum cross section solid	1.5 mm ²
Minimum cross section fine stranded	0.14 mm ²
Maximum cross section fine stranded	1.5 mm ²
Wire strip length	8 mm

Technical Data UL/CSA

Cross section UL	30-16 AWG
------------------	-----------

Voltage UL	300 V
Current field wiring	8 A
Current factory wiring	8 A
Cross section CSA	22-14 AWG
Voltage CSA	300 V
Current CSA	5 A

Other

Type of insulation material	Thermoplastic
Color	Grey
Height	12.4 mm
Length	8.4 mm
Depth	19.8 mm
Material attachment screw	None
Material contact base	Steel
Material contact surface	Sn

Classification

ECLASS 11	
ECLASS 8.1	27440402
ETIM 7.0	EC002637
ETIM 6.0	EC002637
ETIM 5.0	EC002637
ETIM 4.0	EC002637

Product compliance

ROHS conformity status	Compliant
REACH-SVHC conformity status	Compliant

Fits with

Commercial Art.No.:	Article-type description:	Description:
25.630.3253.0	PCB connector 8513 BFK / 2 TOP OB	PCB female connector with tension spring connection, 2 poles, max. cross section: 1.5 mm ² , pitch: 3.5 mm, type of packing: carton, color: grey
25.630.0253.0	PCB connector 8513 BFK / 2 TOP	PCB female connector with tension spring connection, 2 poles, printed version, max. cross section: 1.5 mm ² , pitch: 3.5 mm, type of packing: carton, color: grey

für folgende Tabellen-Zchnng.:
25.642.3253.0 8513 SUFK/ ...OB

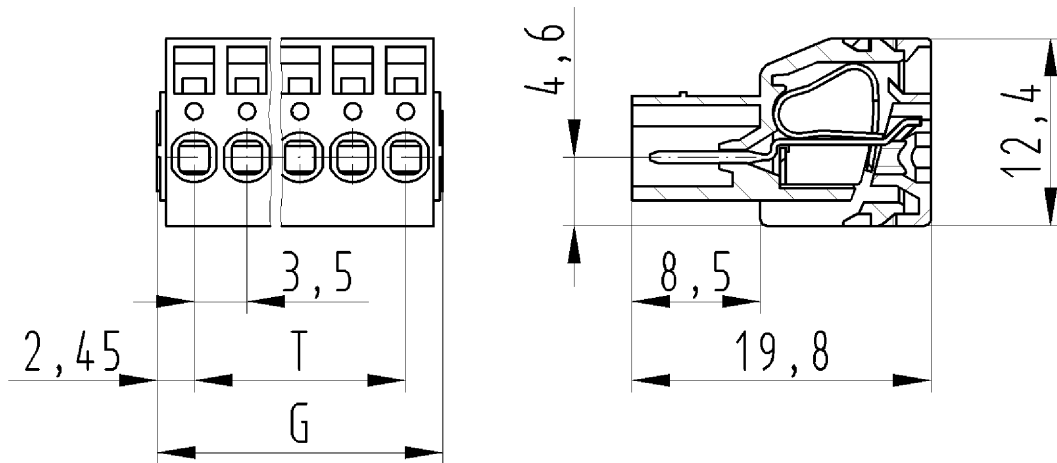

LP-Steckklemme
25.642.3253.0 10W
22.10.2007 DÜT
M 2:1