

DETAILS

Product Number	C12469_LISA2-R-PIN
Family	Lisa
Type	Reflector
Color	white
Diameter	9,9 mm
Height	6,5 mm
Style	round
Optic Material	HRPC
Holder Material	
Fastening	glue, pin
Status	production ready
ROHS Compliant	Yes
Date Updated	12/03/2015

OPTICAL PROPERTIES

LED	Viewing	Light	Effi-	cd/lm	Connector
	Angle	Beam	ciency		
XP-E	82 deg	WWW-class	86 %	0.350	-
XB-D	81 deg	WWW-class	87 %	0.380	-
XP-G	86 deg	WWW-class	89 %	0.330	-
XQ-E	sim: 76	WWW-class	sim: 90 %	sim: 0.450	-
XT-E	80 deg	WWW-class	85 %	0.460	-
XP-L	sim: 81	WWW-class	sim: 83 %	sim: 0.360	-
LUXEON Rebel	77 deg	WWW-class	88 %	0.410	-
LUXEON Rebel ES	83 deg	WWW-class	90 %	0.360	-
LUXEON A	83 deg	WWW-class	88 %	0.370	-
LUXEON T	82 deg	WWW-class	82 %	0.400	-
LUXEON Z	78 deg	WWW-class	86 %	0.440	-
LUXEON H50-2	sim: 80	WWW-class	sim: 90 %	sim: 0.440	-
LUXEON C	84 deg	WWW-class	83 %	0.380	-
NCSxx19A	78 deg	WWW-class	84 %	0.460	-
NVSxx19A	80 deg	WWW-class	84 %	0.400	-
Oslon SSL 80	76 deg	WWW-class	92 %	0.500	-
Oslon SSL 150	83 deg	WWW-class	91 %	0.300	-
Oslon Square EC	82 deg	WWW-class	85 %	0.370	-
Duris P5	78 deg	WWW-class	83 %	0.400	-
Z5	80 deg	WWW-class	84 %	0.360	-
Z8Y19	76 deg	WWW-class	86 %	0.435	-
Z8Y15	76 deg	WWW-class	87 %	0.430	-



Relative intensity of C12469_LISA2-R-PIN_(XT-E)

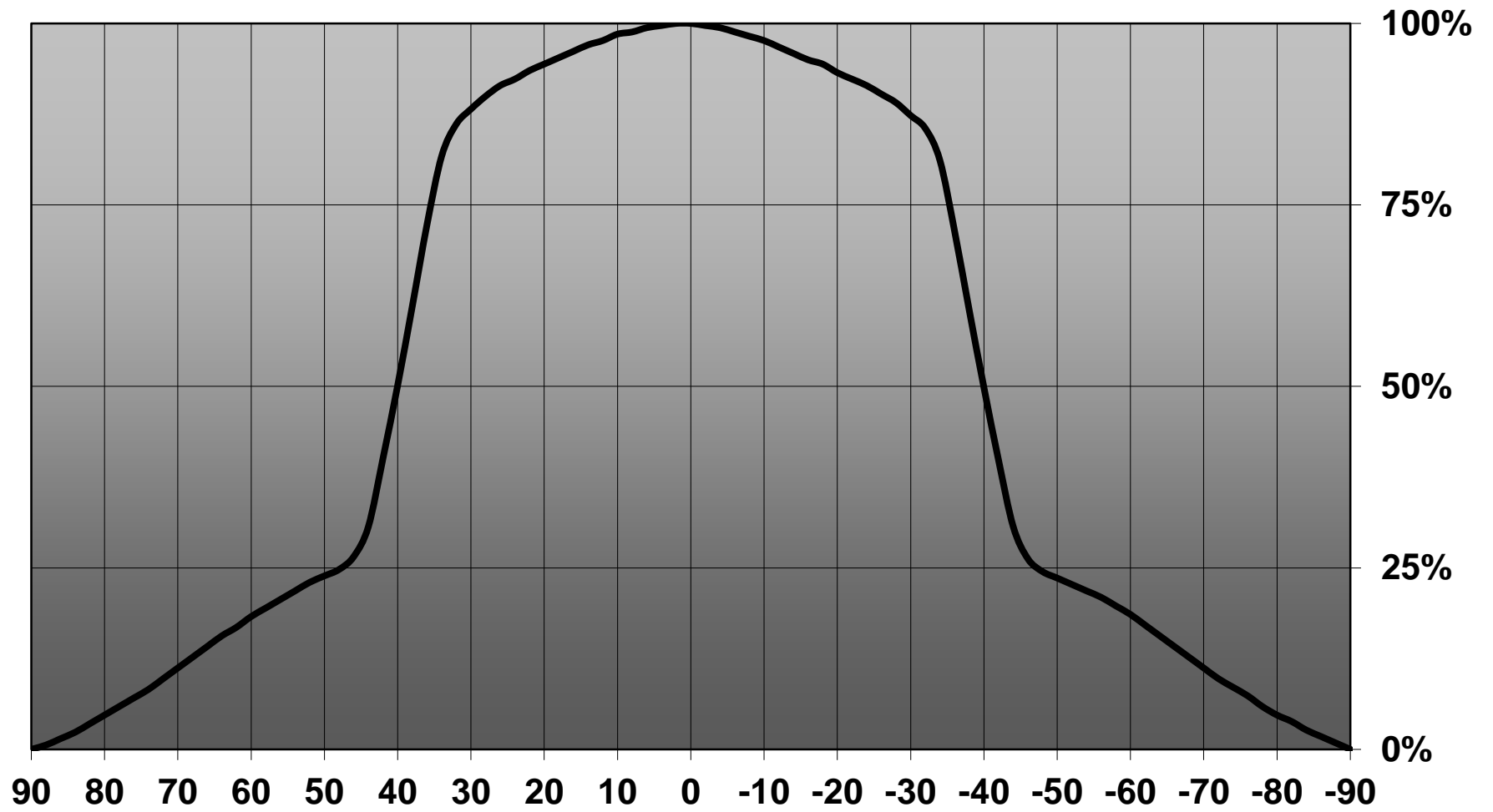

Relative intensity of C12469_LISA2-R-PIN_(Luxeon Z)

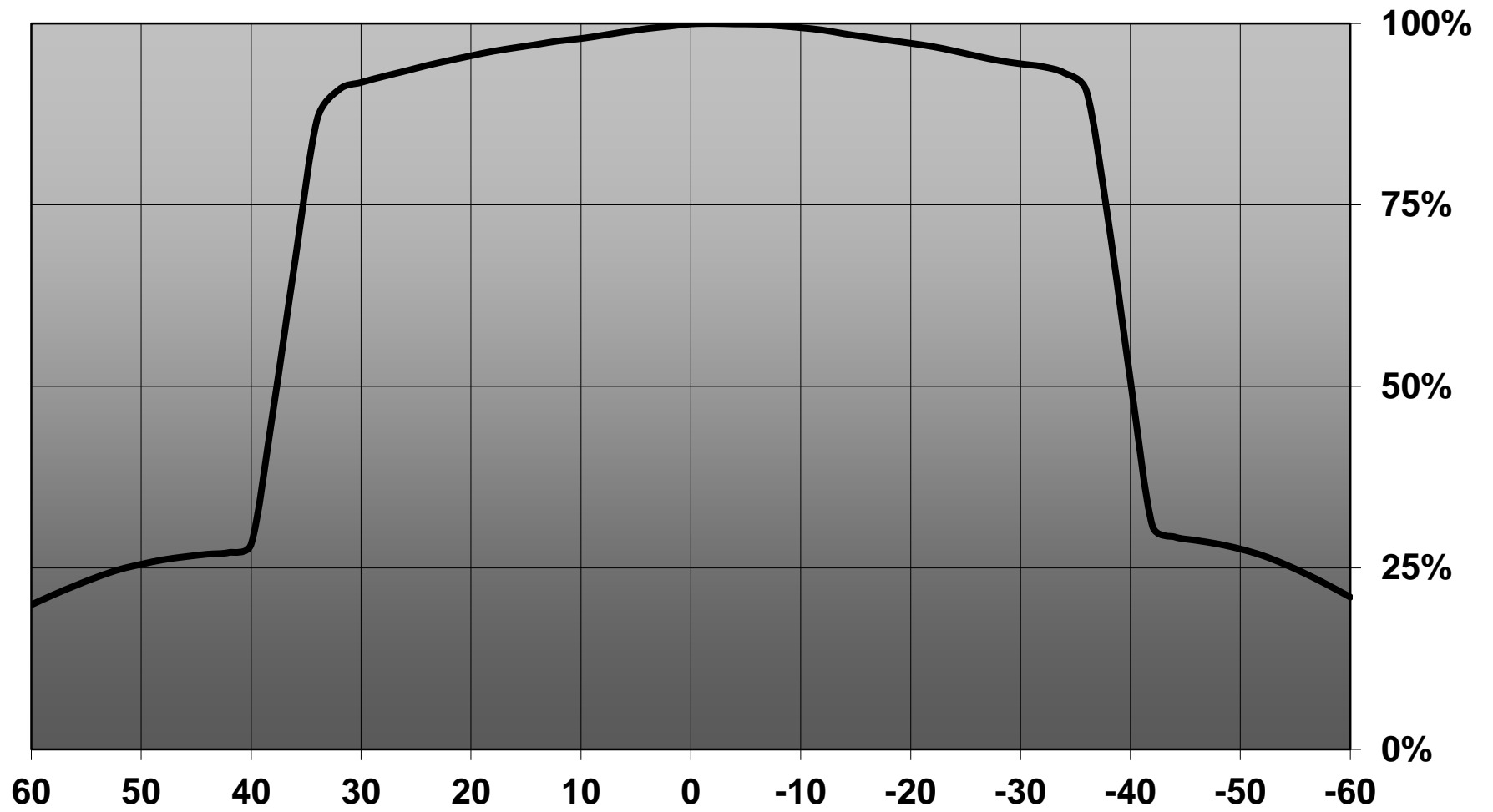

Relative intensity of C12469_LISA2-R-PIN_(Luxeon_C_White)

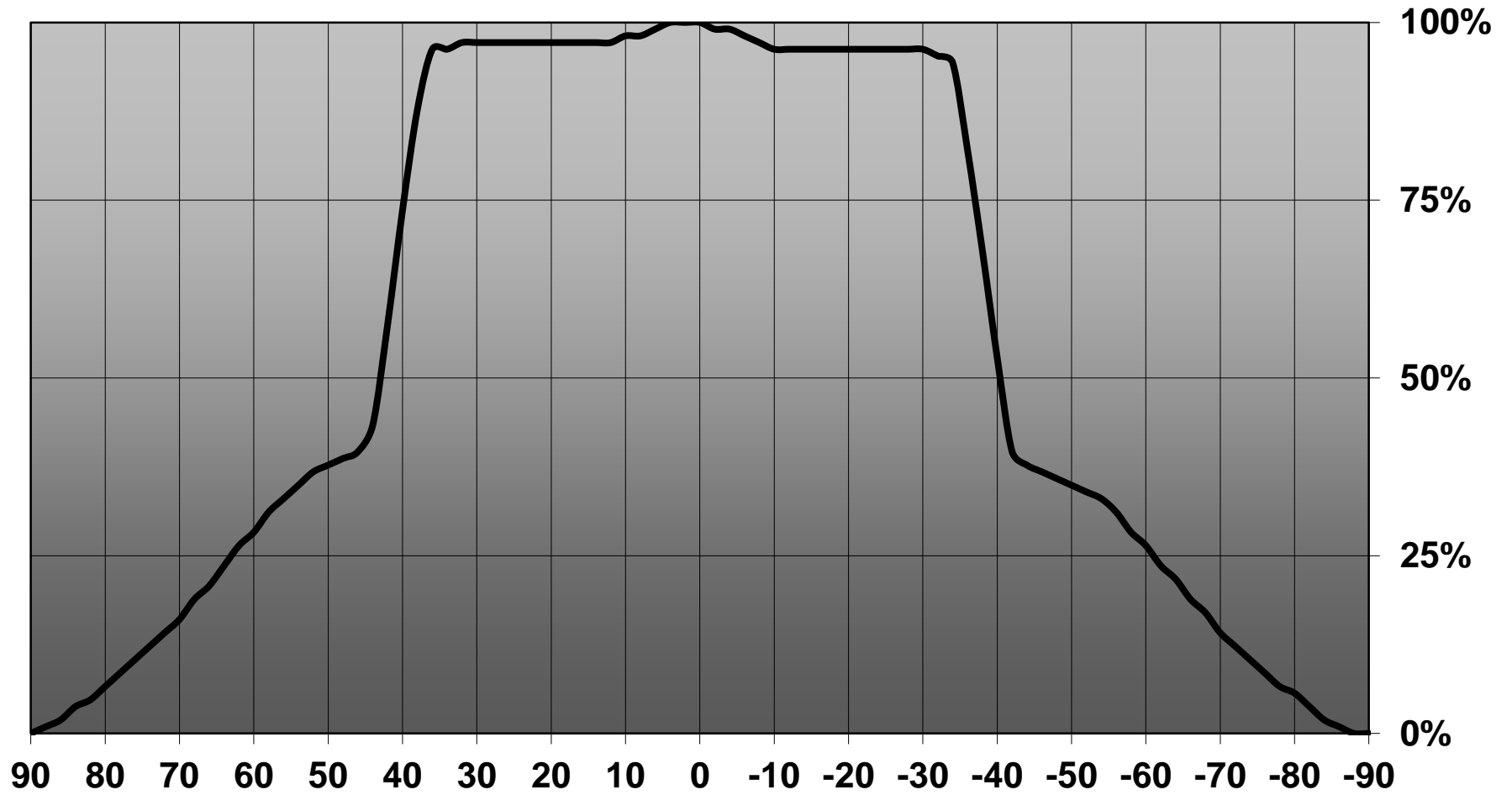

Relative intensity of C12469_LISA2-R-PIN_(SZ8_Y19)

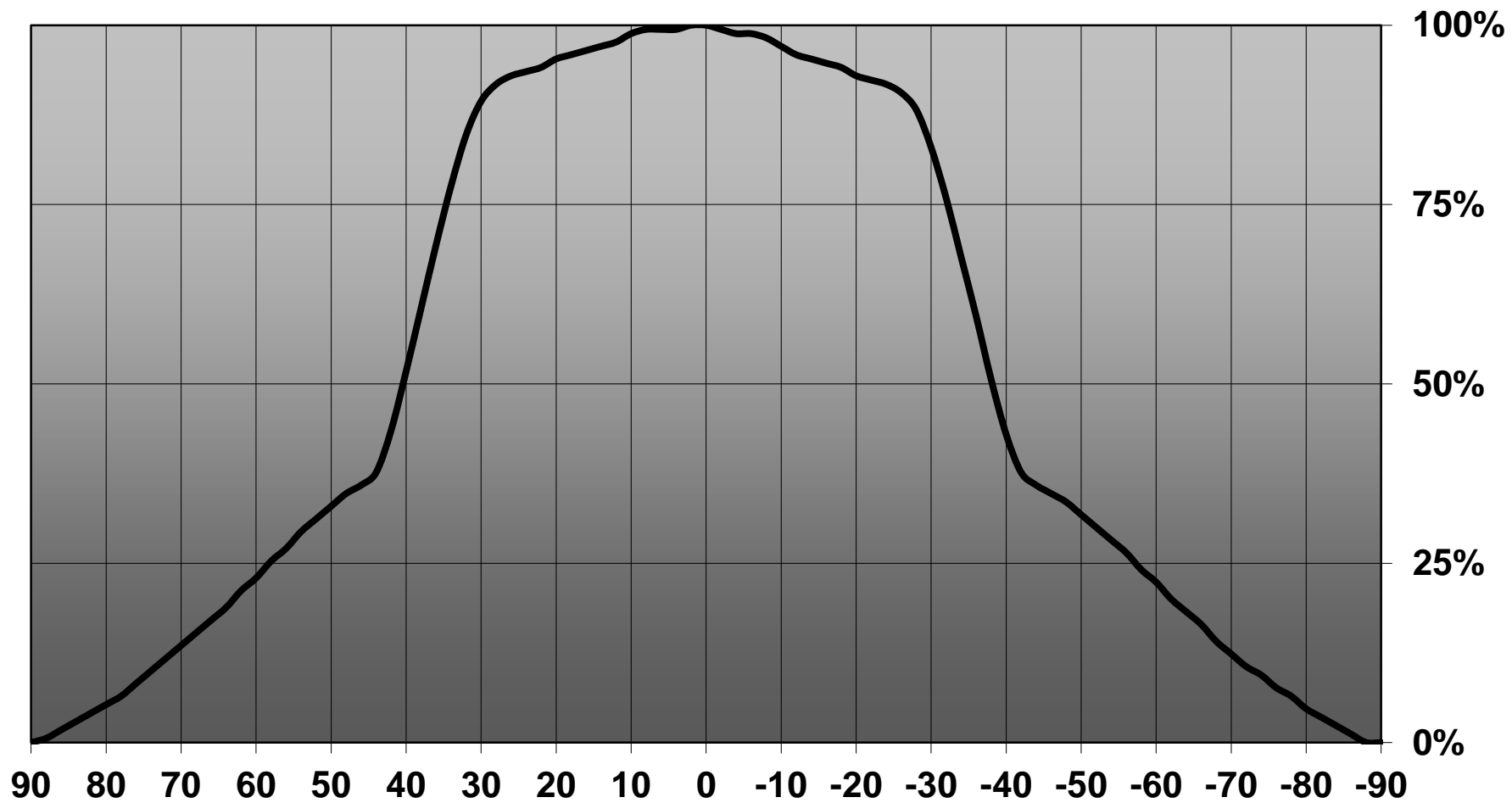

Relative intensity of C12469_LISA2-R-PIN_(SZ8_Y15)

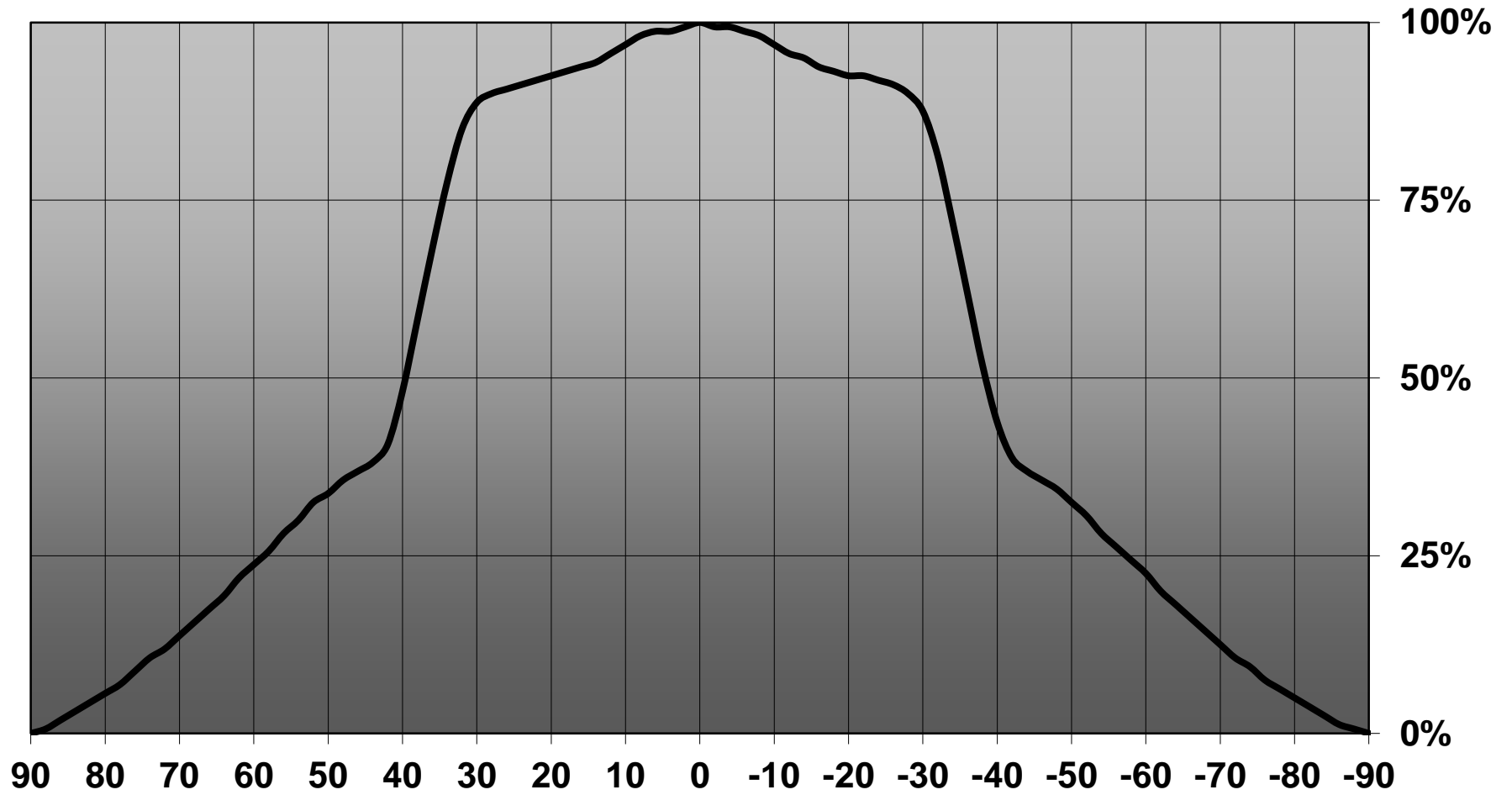

D

C

B

A

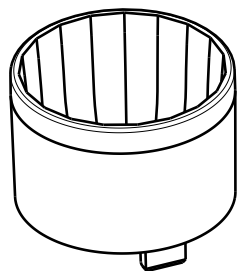

Isometric view

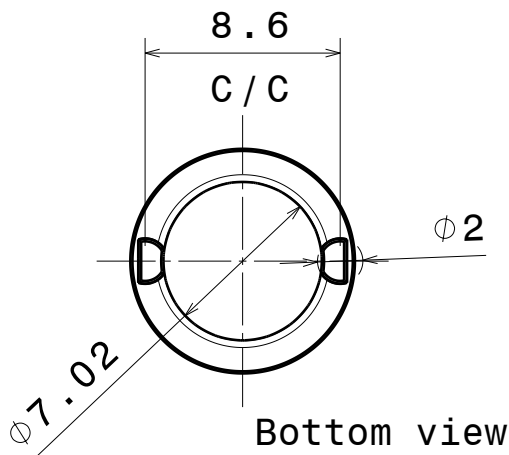

Bottom view

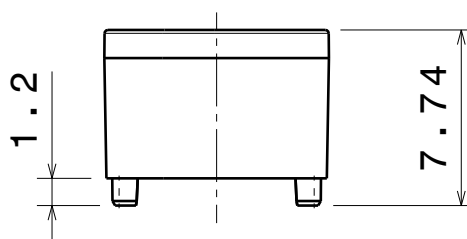

Front view

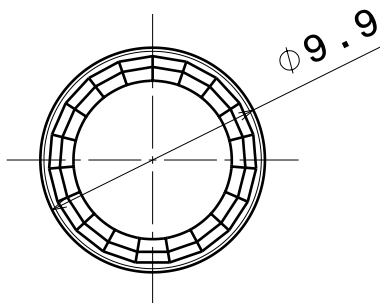

Top view

Reflector material : PC

Tolerances if not otherwise shown
 According to DIN ISO 2768-1
 Linear measures:
 Up to 30mm class M, otherwise class C.
 According to DIN ISO 2768-2
 Form and position: class L



Ledil Oy
 Salorankatu 10
 FIN 24240 SALO
 Finland

THIRD ANGLE PROJECTION:

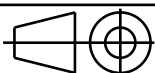

DRAWING TITLE

Datasheet_Lisa2-reflector

This drawing is the property
 of LEDiL Oy. It may not be
 reproduced, copied or
 communicated without a written
 agreement with LEDiL Oy."

SIZE PART NUMBER

A4

-

SCALE 3:1 WEIGHT

-

SHEET 1/1

D

A

4

4

3

3

2

2

1

1

Luminaire: Ledil Oy C12469_LISA2-R-PIN (Cree XP-G 66lm @ 250mA) Efficiency=89%
Lamps: 1 x Cree XP-G 66lm @ 250mA CCT=3270K P=0,75W I=250mA

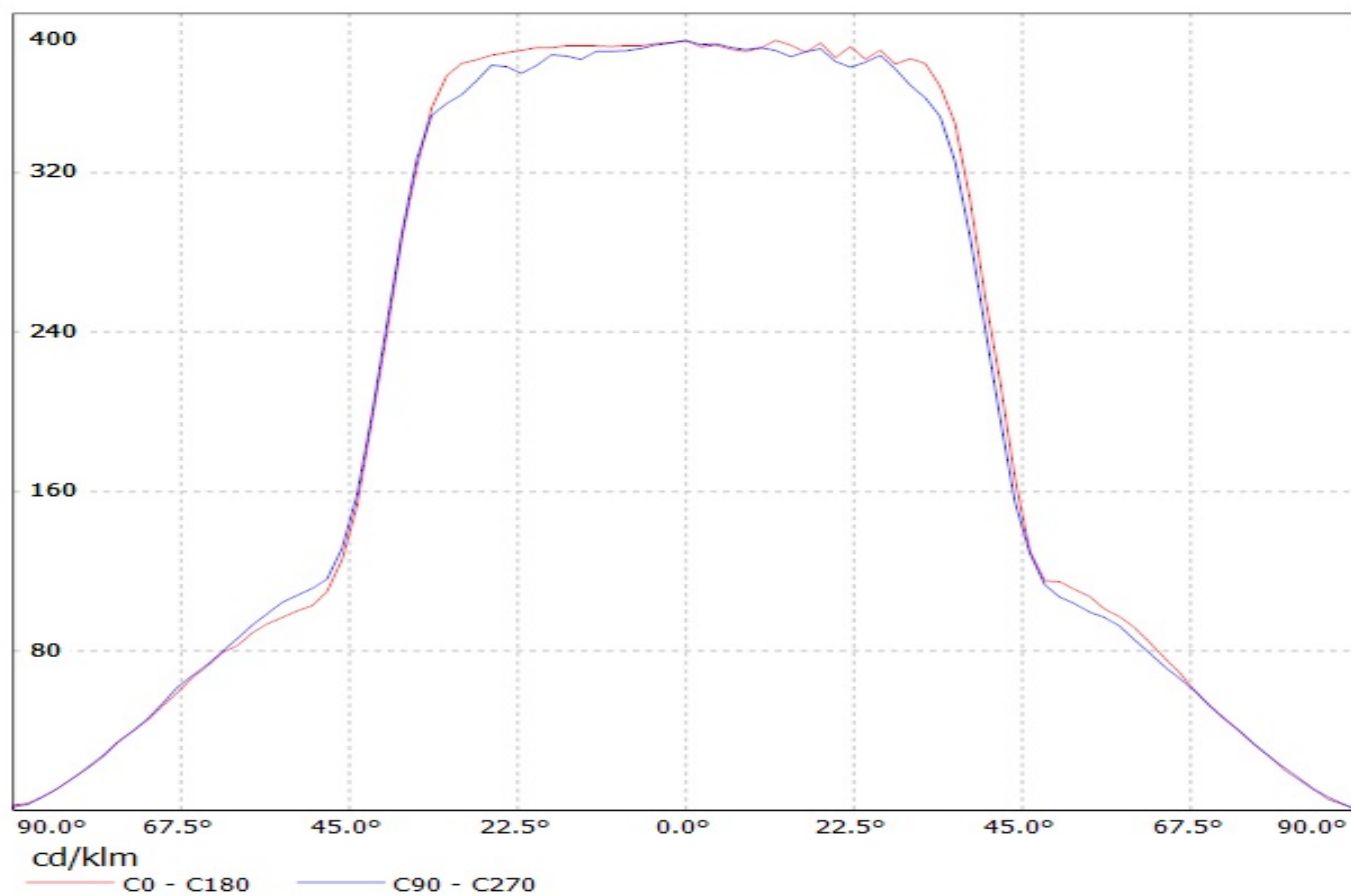

Luminaire: Ledil Oy C12469_LISA2-R-PIN (Luxeon Rebel 61lm @ 250mA) Efficiency=88%
Lamps: 1 x Luxeon Rebel 61lm @ 250mA (LXM8-PW30) CCT=2872K P=0,75W I=250mA

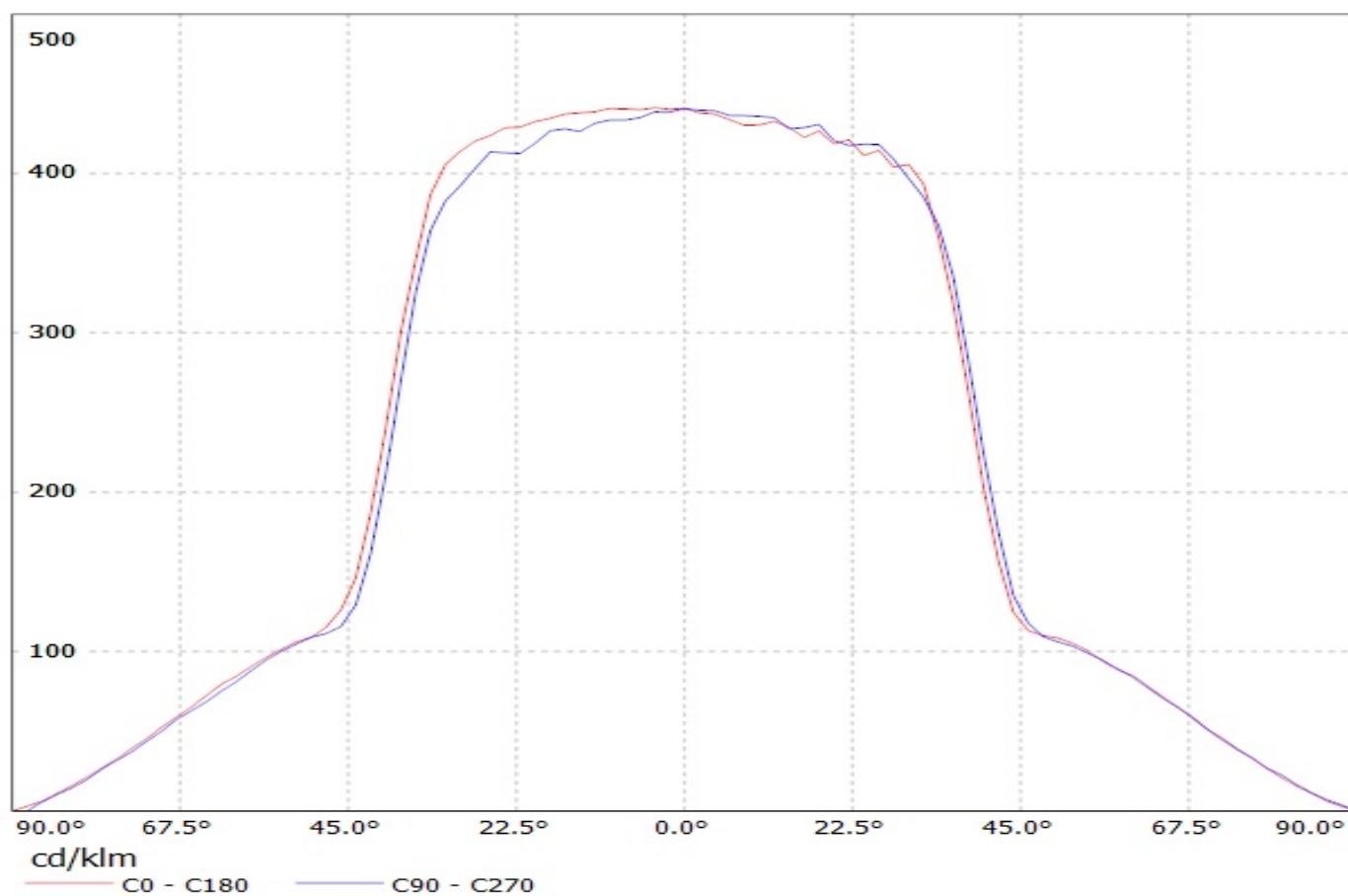

LEDiL Oy C12469_LISA2-R-PIN_(LUXEON_T) Eff.81.8% / LDC (Linear)

Luminaire: LEDiL Oy C12469_LISA2-R-PIN_(LUXEON_T) Eff.81.8%
Lamps: 1 x LUXEON T (74lm@250mA)

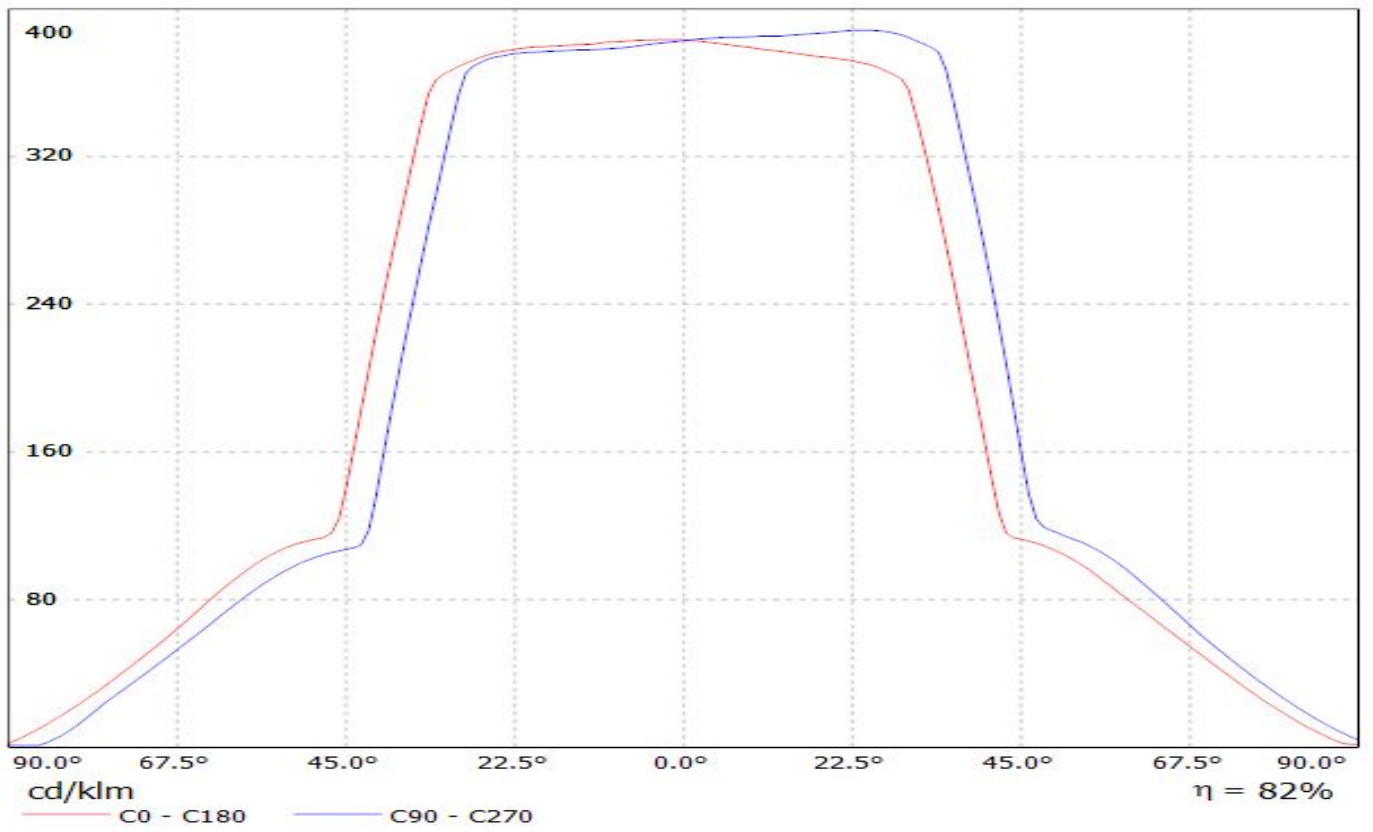

Luminaire: LEDiL C12469_LISA2-R-PIN_(SSL80) Eff.92%
Lamps: 1 x Osram Oslon SSL80 (79lm@250mA)

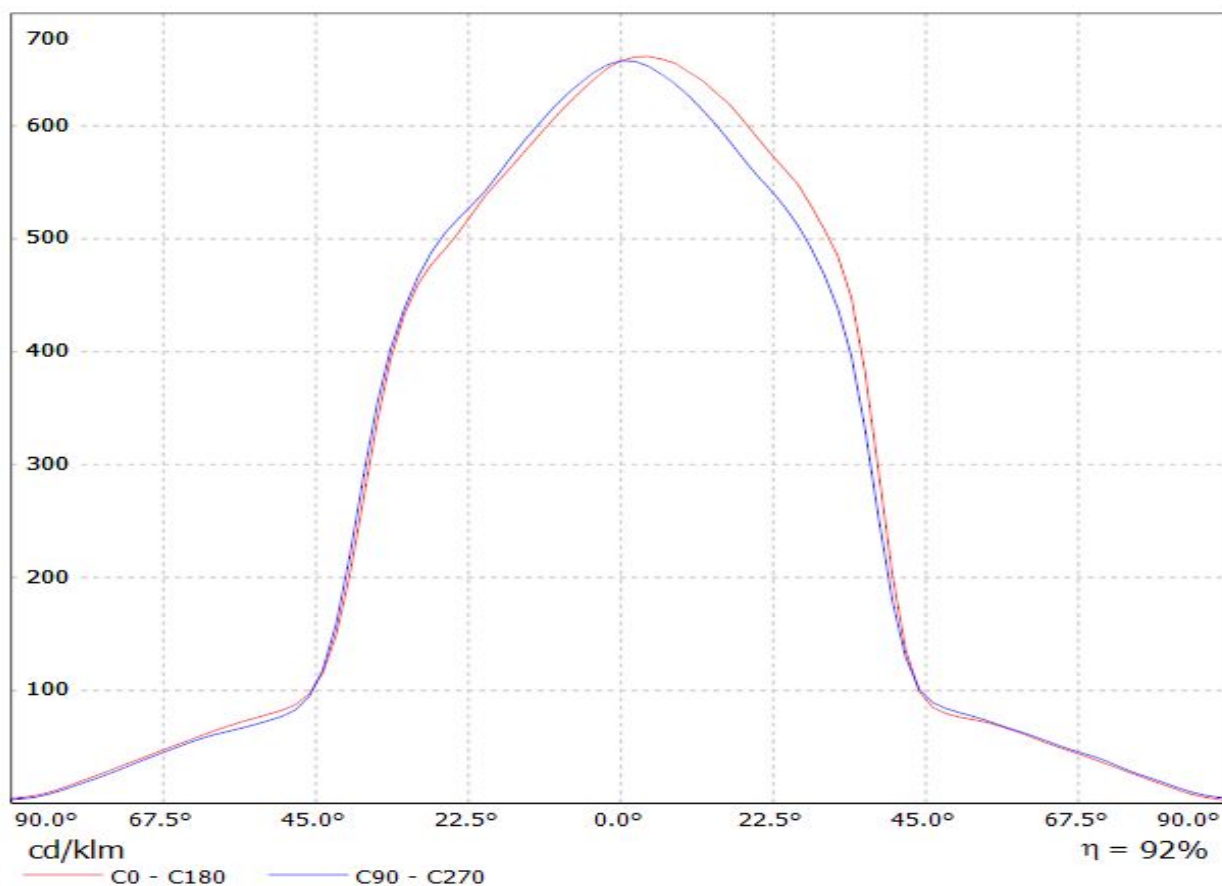

Luminaire: Ledil Oy C12469_LISA2-R-PIN_SQAR_EC_SIMULATED
Lamps: 1 x Osram_Oslon Square EC

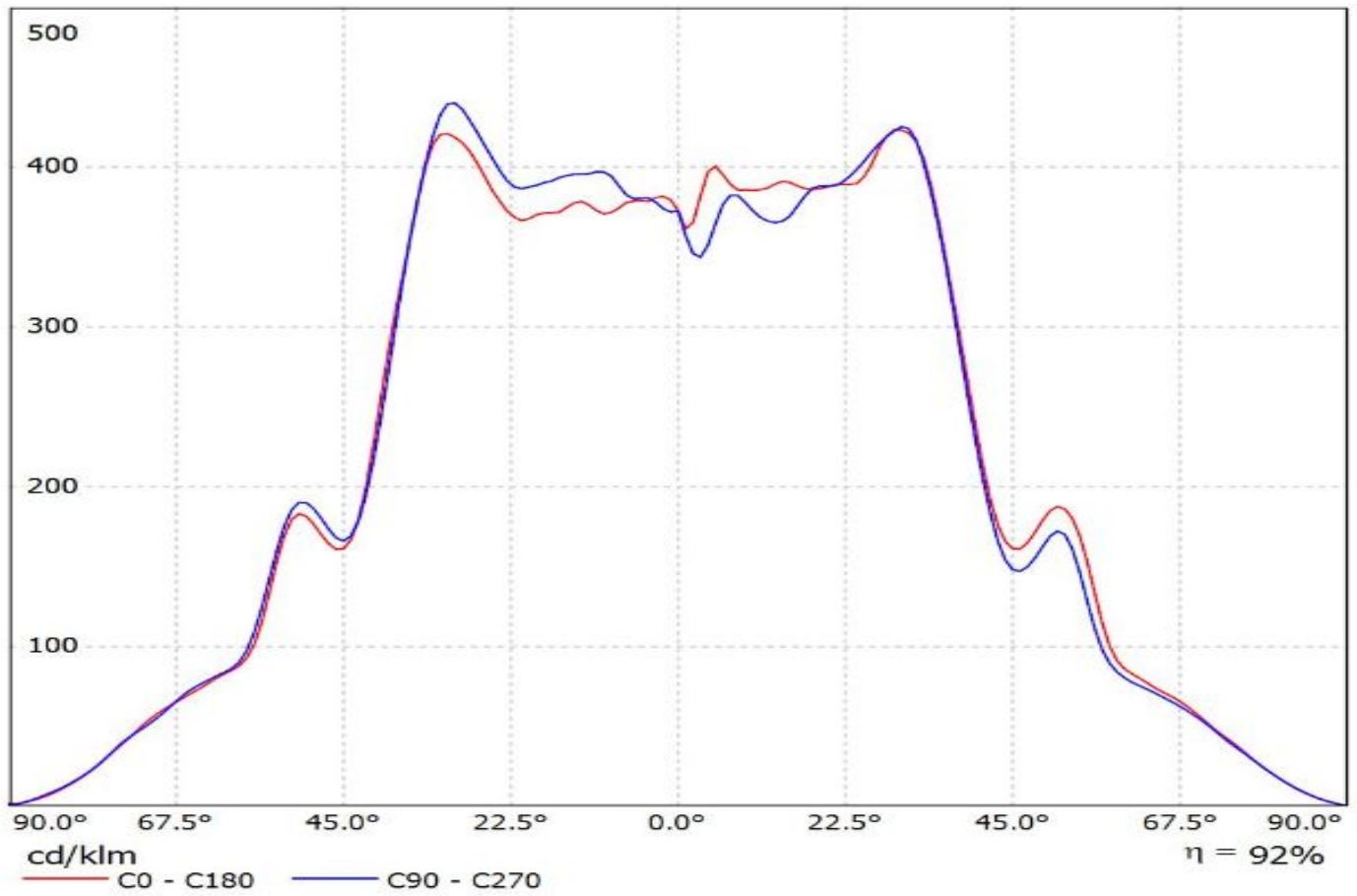

Luminaire: LEDiL Oy C12469_LISA2-R-PIN (DURIS_P5) Eff: 83%
Lamps: 1 x OSRAM_DURIS_P5_(GWDASPA1.EC-HPHR-5R8T-1)_26.9258lm@100mA_P=0.29332W_I=100.2mA

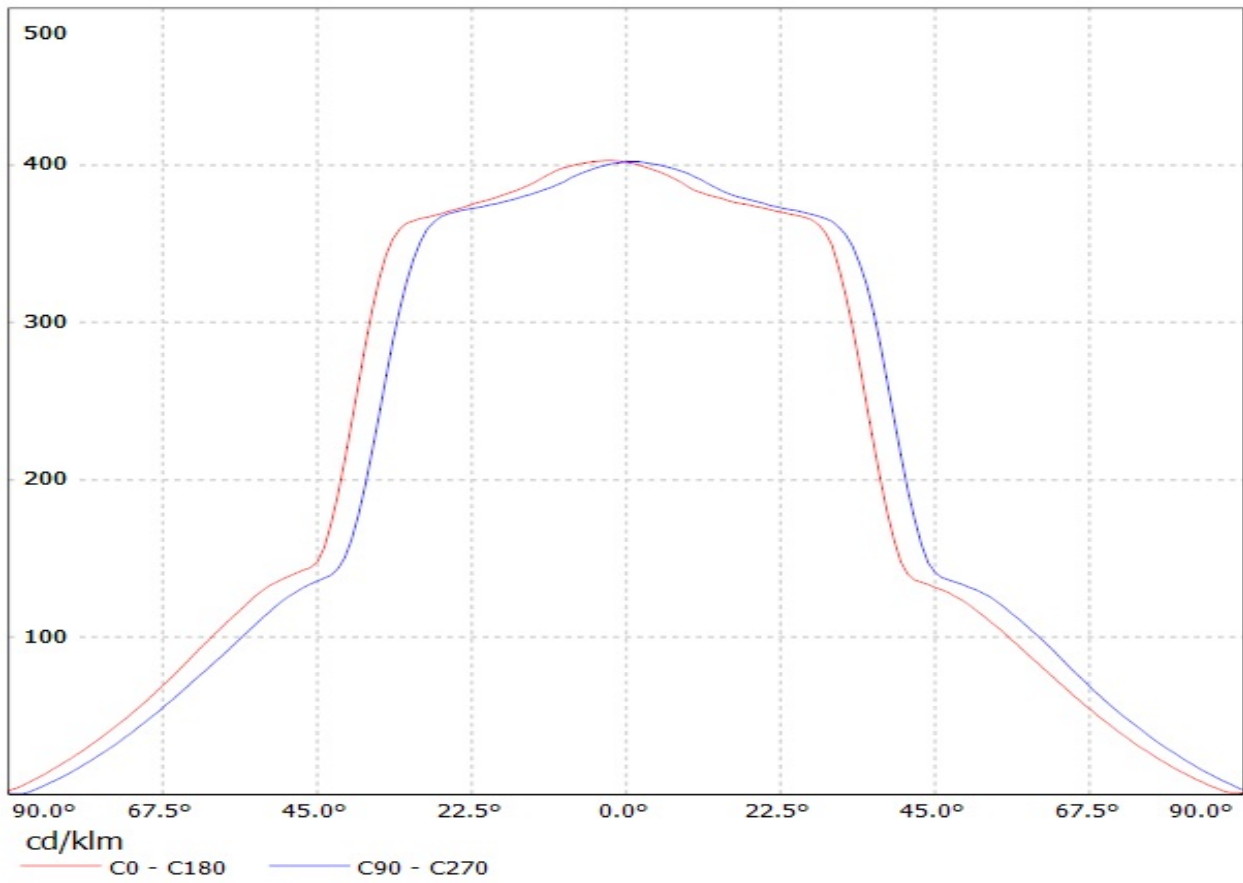

Luminaire: Ledil Oy C12469_LISA2-R-PIN_(Seoul-Z5) Efficiency=85%
Lamps: 1 x Seoul Z5 (SZW05AOB) 82lm@250mA CCT=6000K P=0.8W I=250mA

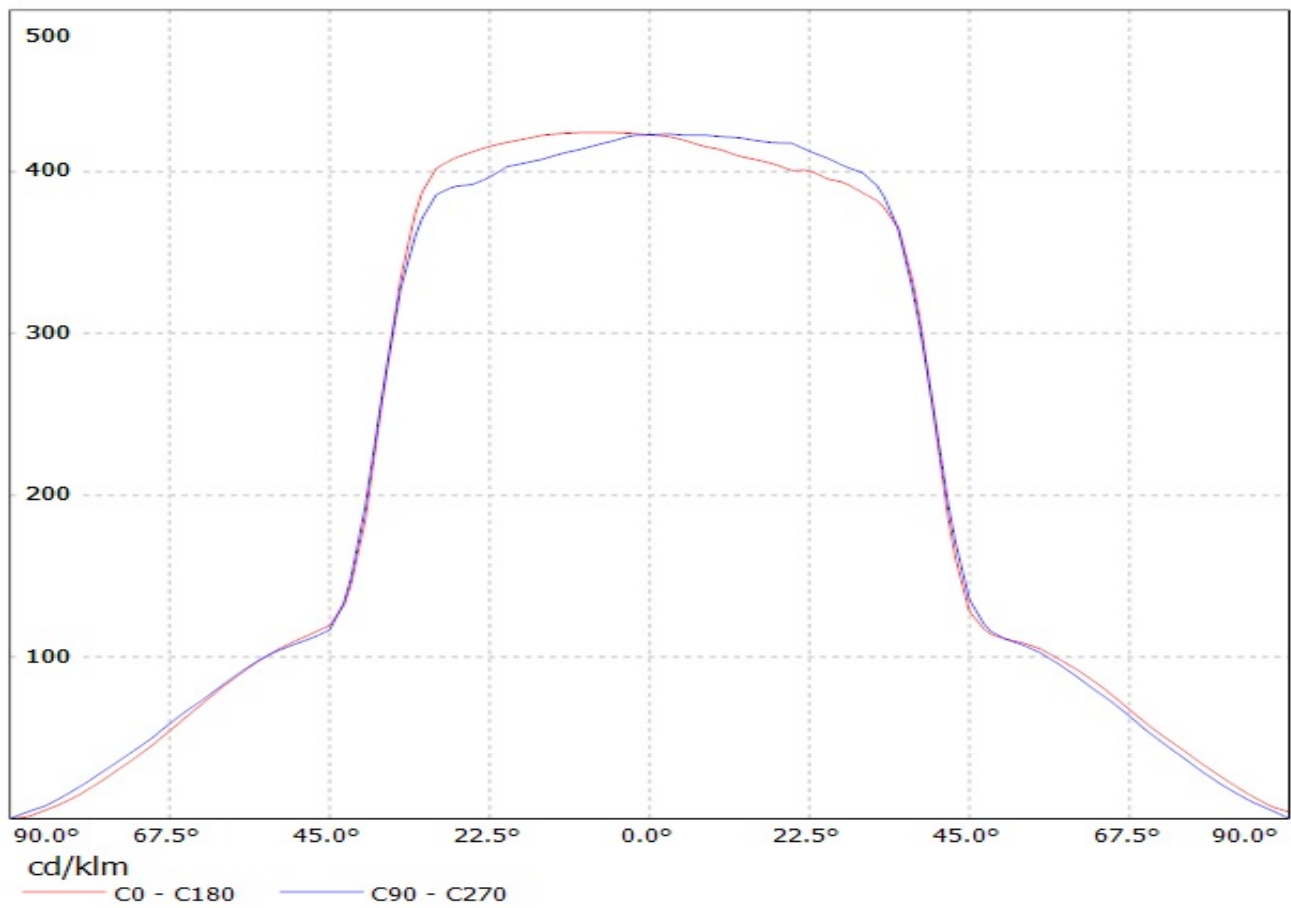

Luminaire: Ledil C12469_LISA2-R-PIN_(Z8Y19)
Lamps: 1 x Seoul_Z8Y19_111.337lm@250mA_P=0.7402W_I=0.25

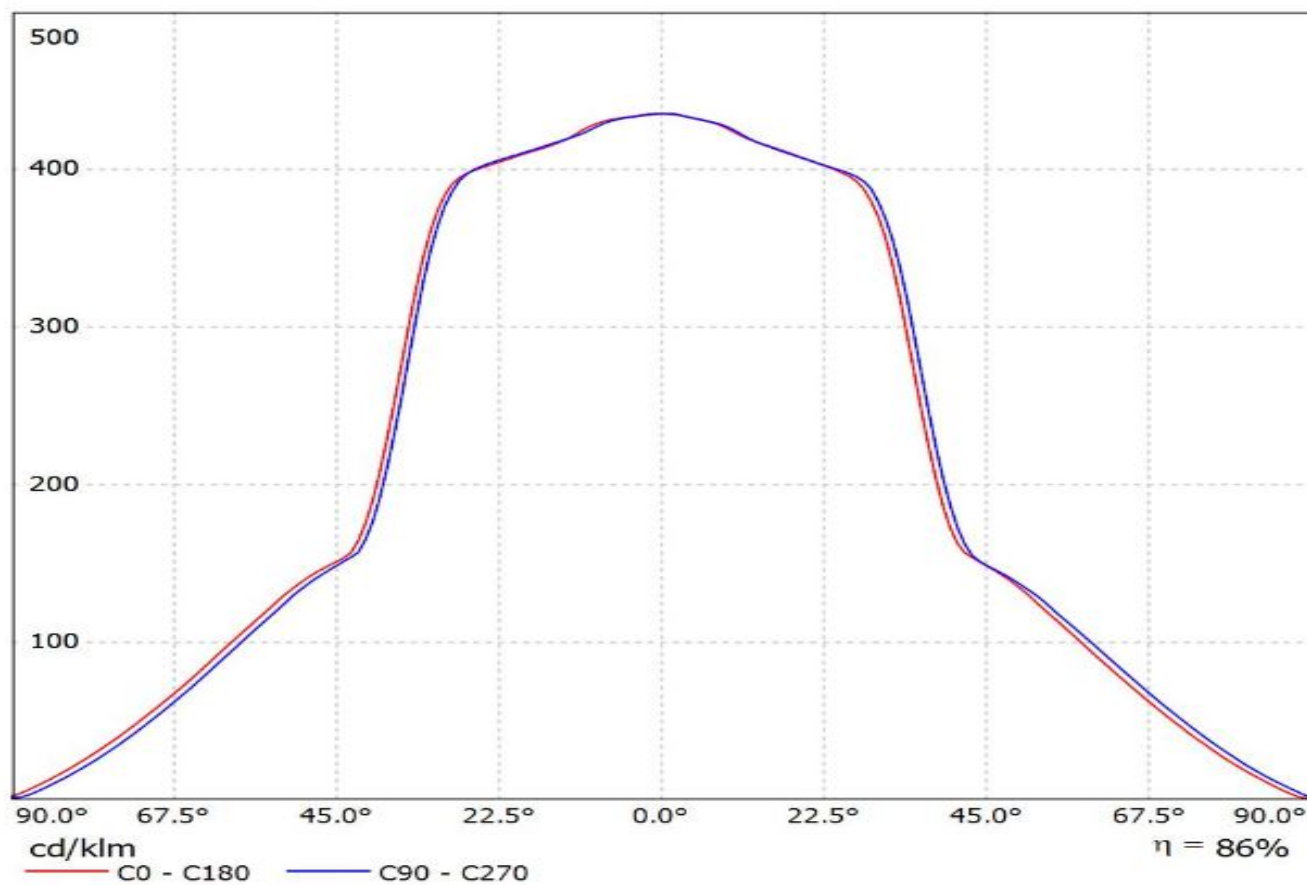

Luminaire: Ledil C12469_LISA2-R-PIN_(Z8Y15)
Lamps: 1 x Seoul_Z8Y15_99.8967lm@250mA_P=0.7569W_I=0.25A

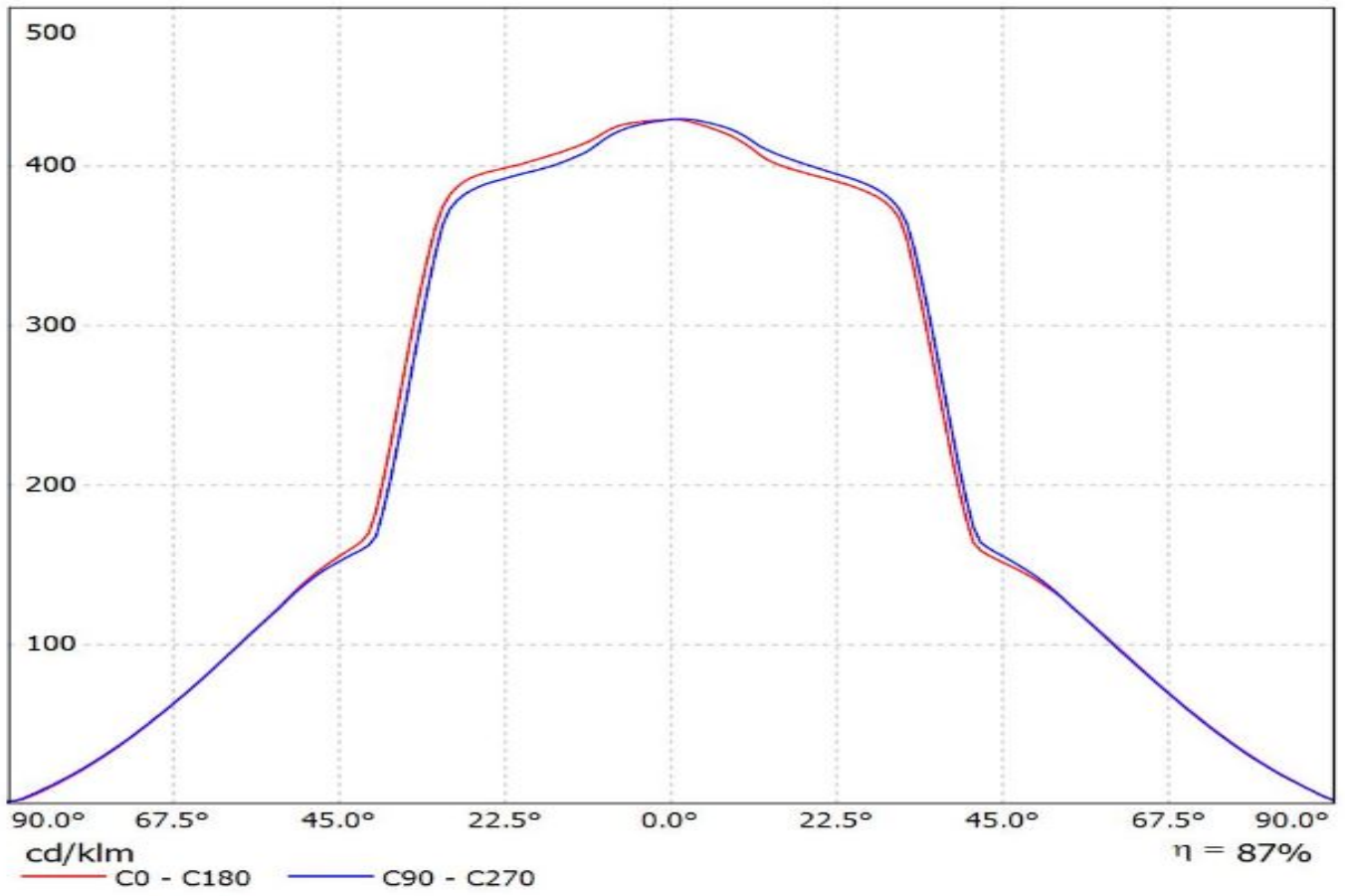

Luminaire: Ledil Oy C12469_LISA2-R-PIN (Cree XP-G 66lm @ 250mA) Efficiency=89%
Lamps: 1 x Cree XP-G 66lm @ 250mA CCT=3270K P=0,75W I=250mA

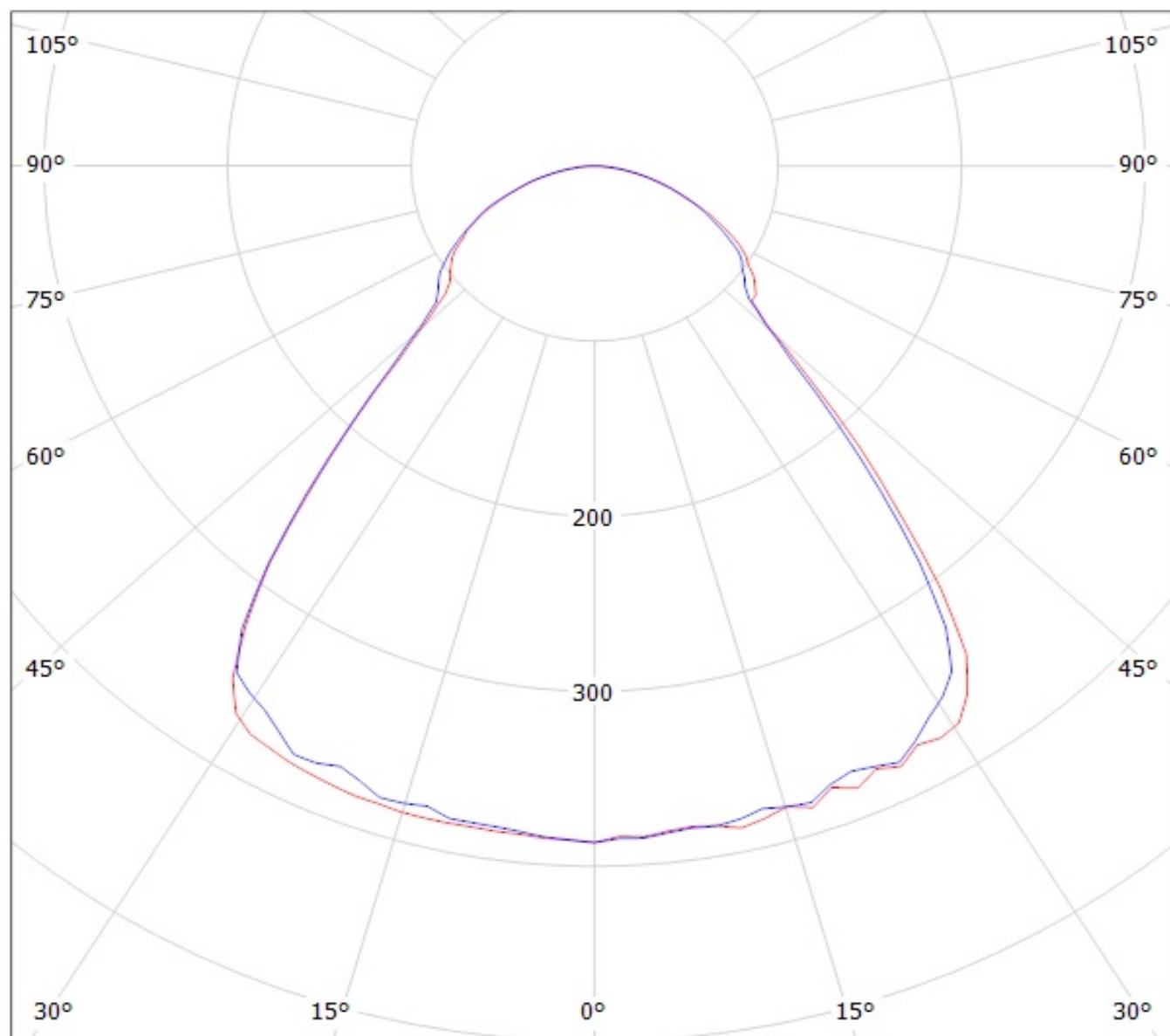

cd/klm

— C0 - C180

— C90 - C270

Luminaire: Ledil Oy C12469_LISA2-R-PIN (Luxeon Rebel 61lm @ 250mA) Efficiency=88%
Lamps: 1 x Luxeon Rebel 61lm @ 250mA (LXM8-PW30) CCT=2872K P=0,75W I=250mA

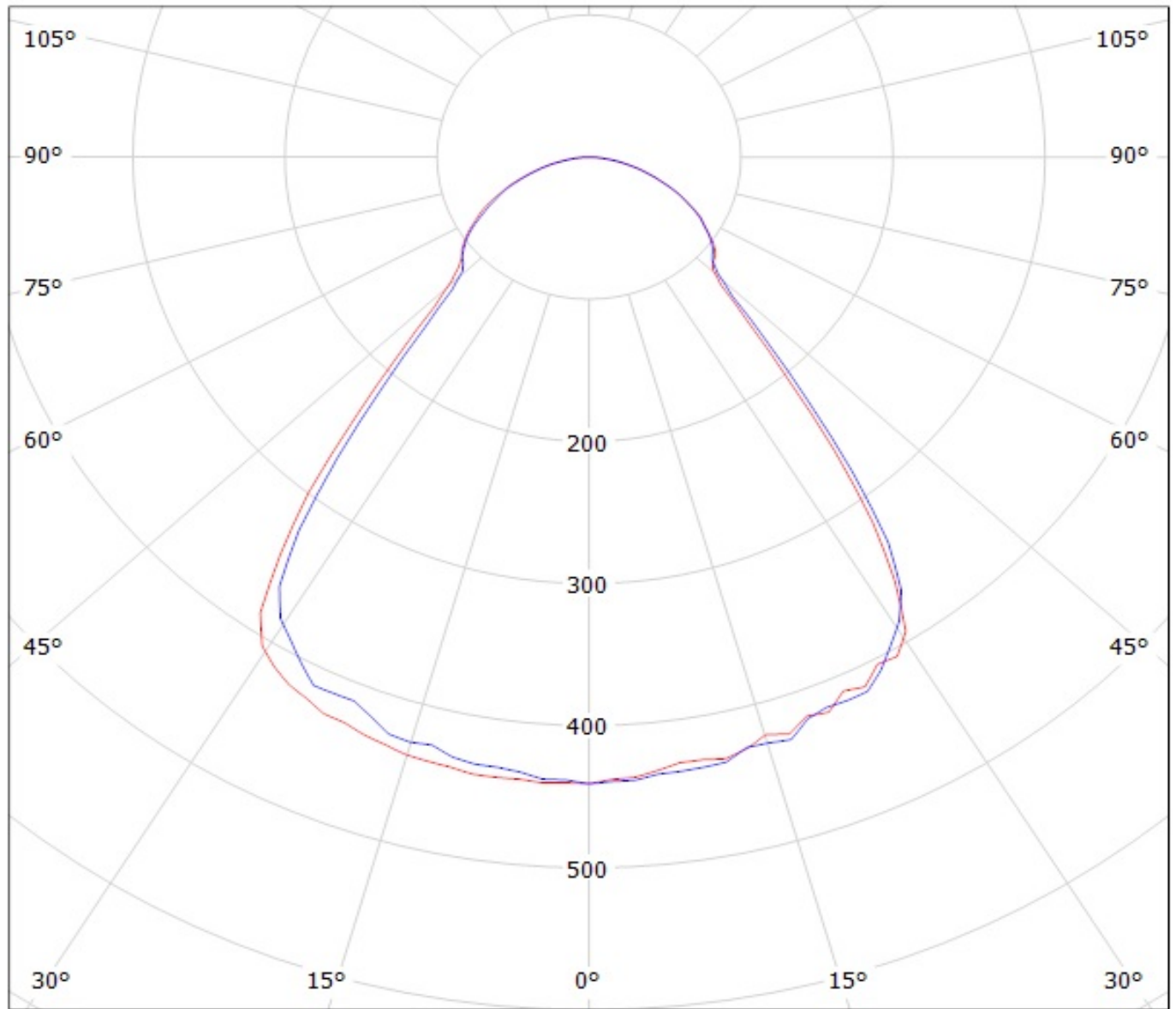

cd/klm

— C0 - C180 — C90 - C270

LEDiL Oy C12469_LISA2-R-PIN_(LUXEON_T) Eff.81.8% / LDC (Polar)

Luminaire: LEDiL Oy C12469_LISA2-R-PIN_(LUXEON_T) Eff.81.8%

Lamps: 1 x LUXEON T (74lm@250mA)

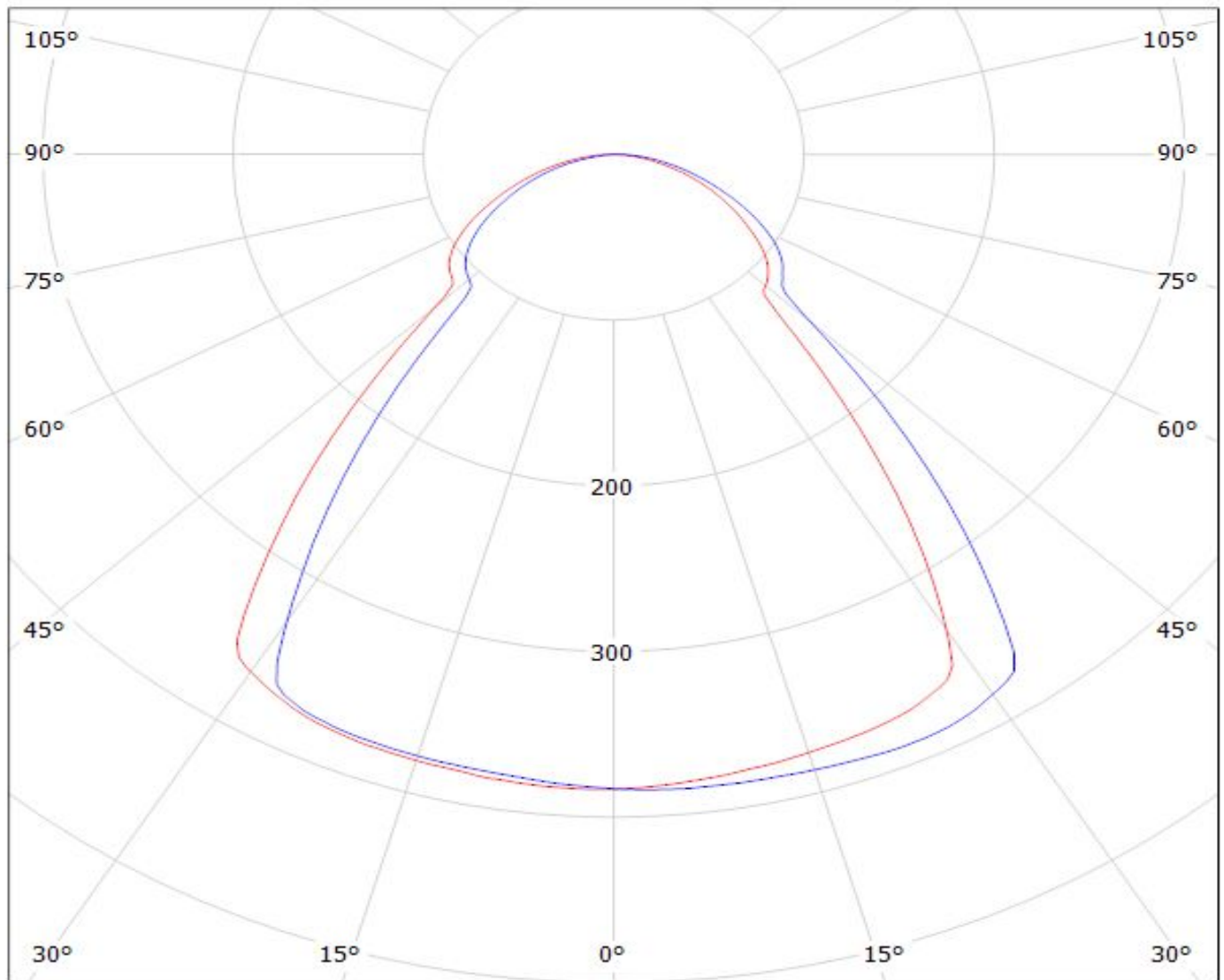

cd/klm

— C0 - C180

— C90 - C270

$\eta = 82\%$

Luminaire: LEDiL C12469_LISA2-R-PIN_(SSL80) Eff.92%
Lamps: 1 x Osram Oslon SSL80 (79lm@250mA)

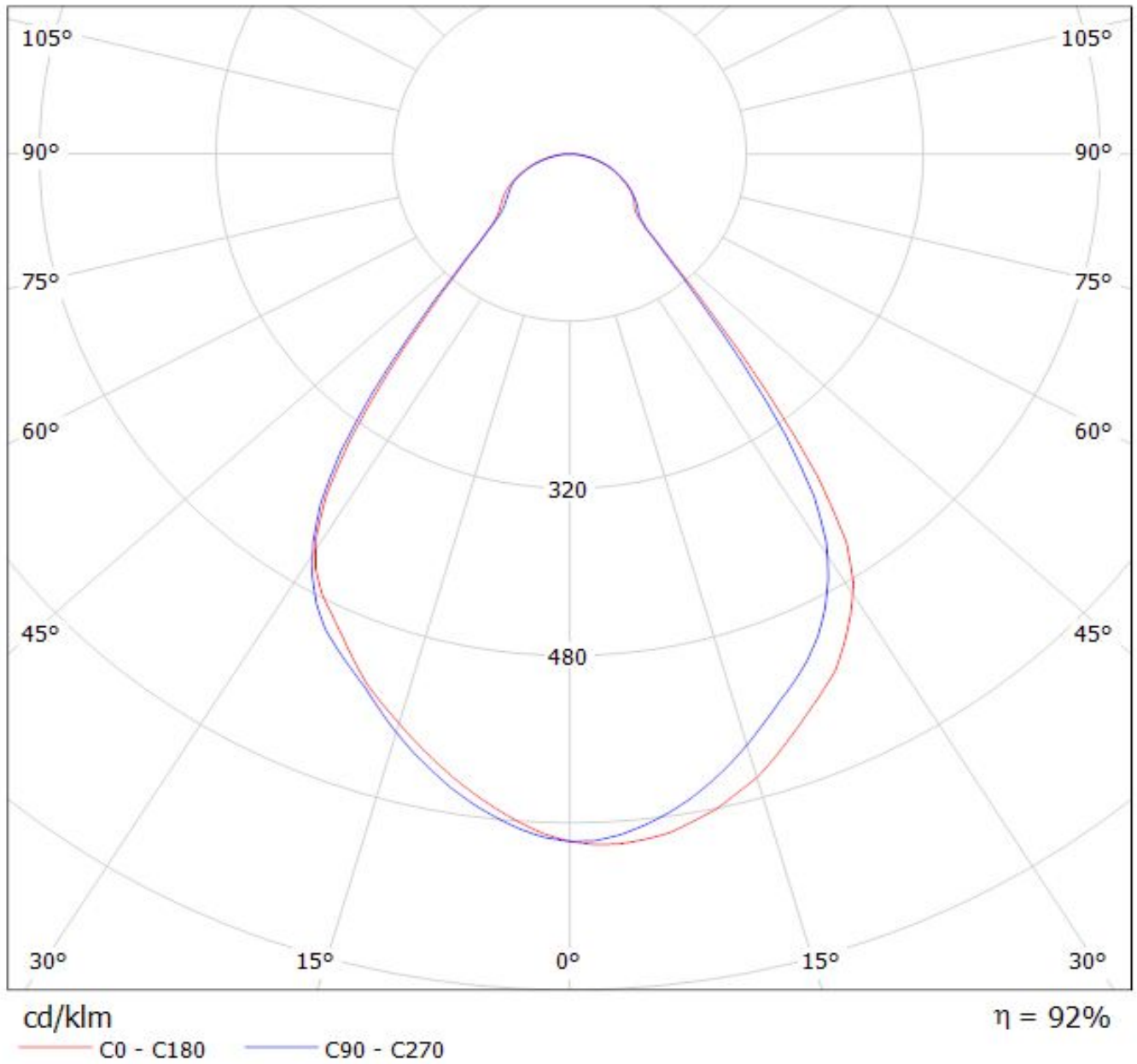

Luminaire: Ledil Oy C12469_LISA2-R-PIN_SQAR_EC_SIMULATED
Lamps: 1 x Osram_Oslon Square EC

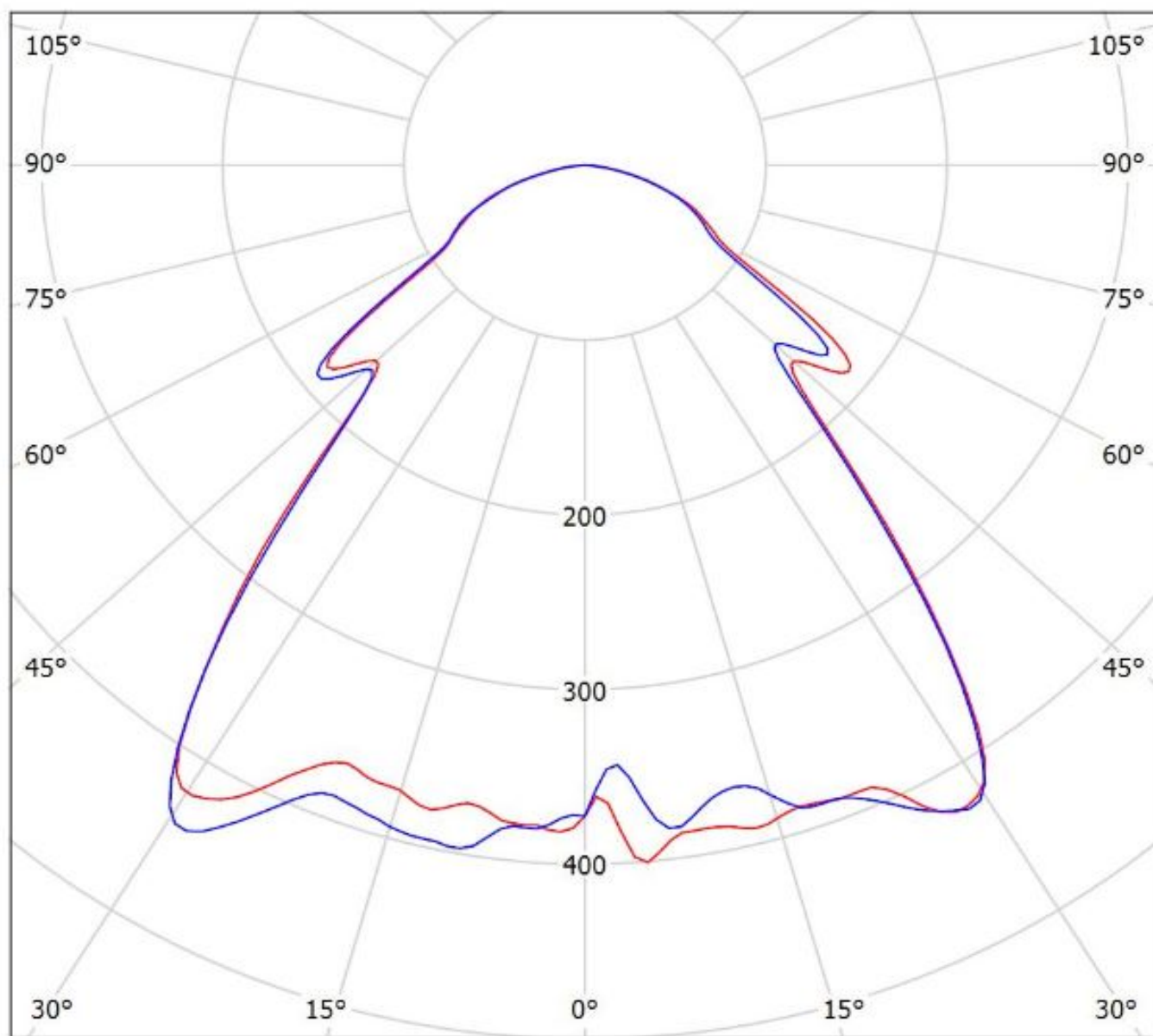

cd/klm

— C0 - C180 — C90 - C270

$\eta = 92\%$

Luminaire: LEDiL Oy C12469_LISA2-R-PIN_(DURIS_P5) Eff: 83%

Lamps: 1 x OSRAM_DURIS_P5_(GWDASPA1.EC-HPHR-5R8T-1)_26.9258lm@100mA_P=0.29332W_I=100.2mA

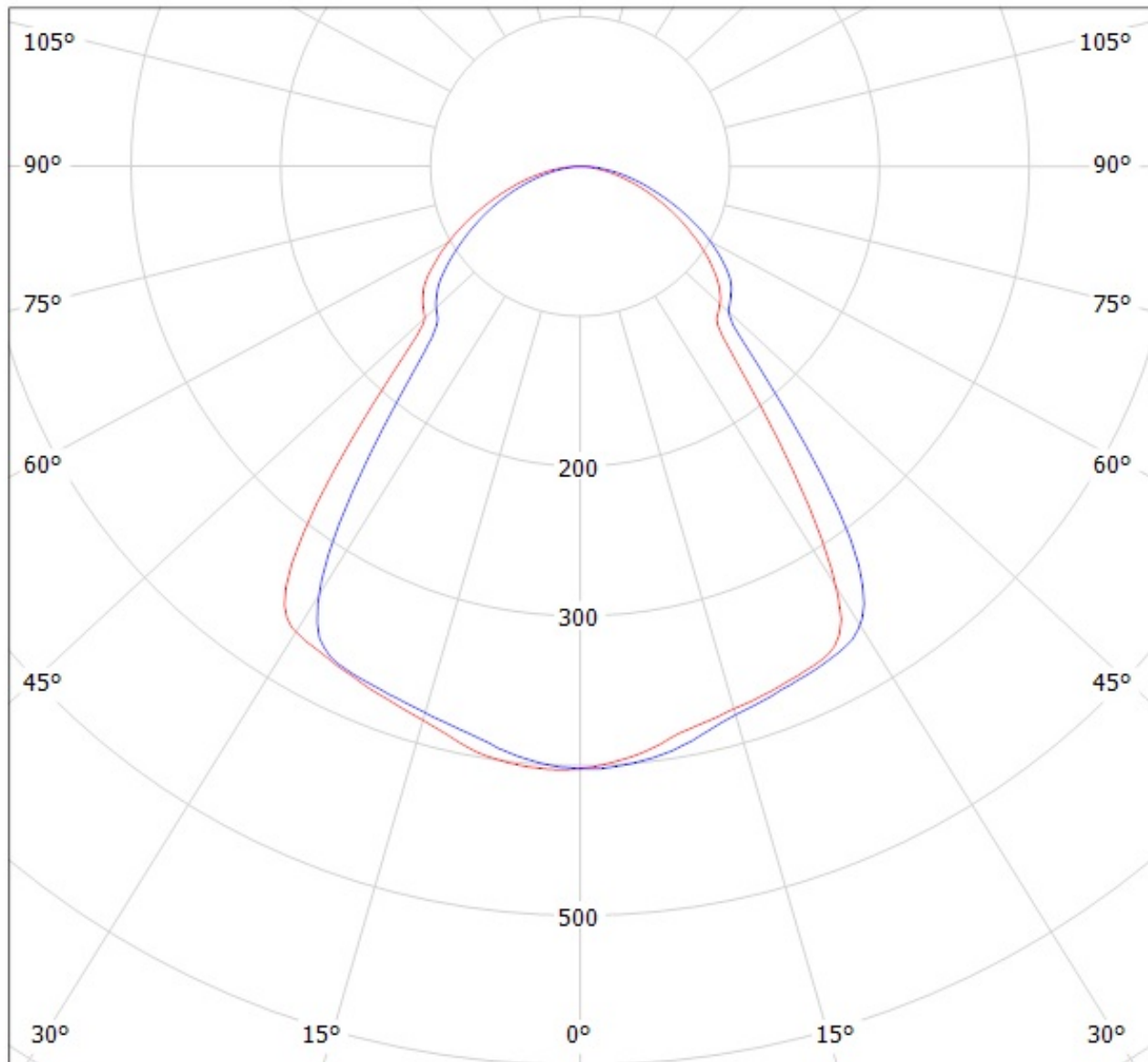

cd/klm

— C0 - C180

— C90 - C270

Luminaire: Ledil Oy C12469_LISA2-R-PIN_(Seoul-Z5) Efficiency=85%
Lamps: 1 x Seoul Z5 (SZW05AOB) 82lm@250mA CCT=6000K P=0.8W I=250mA

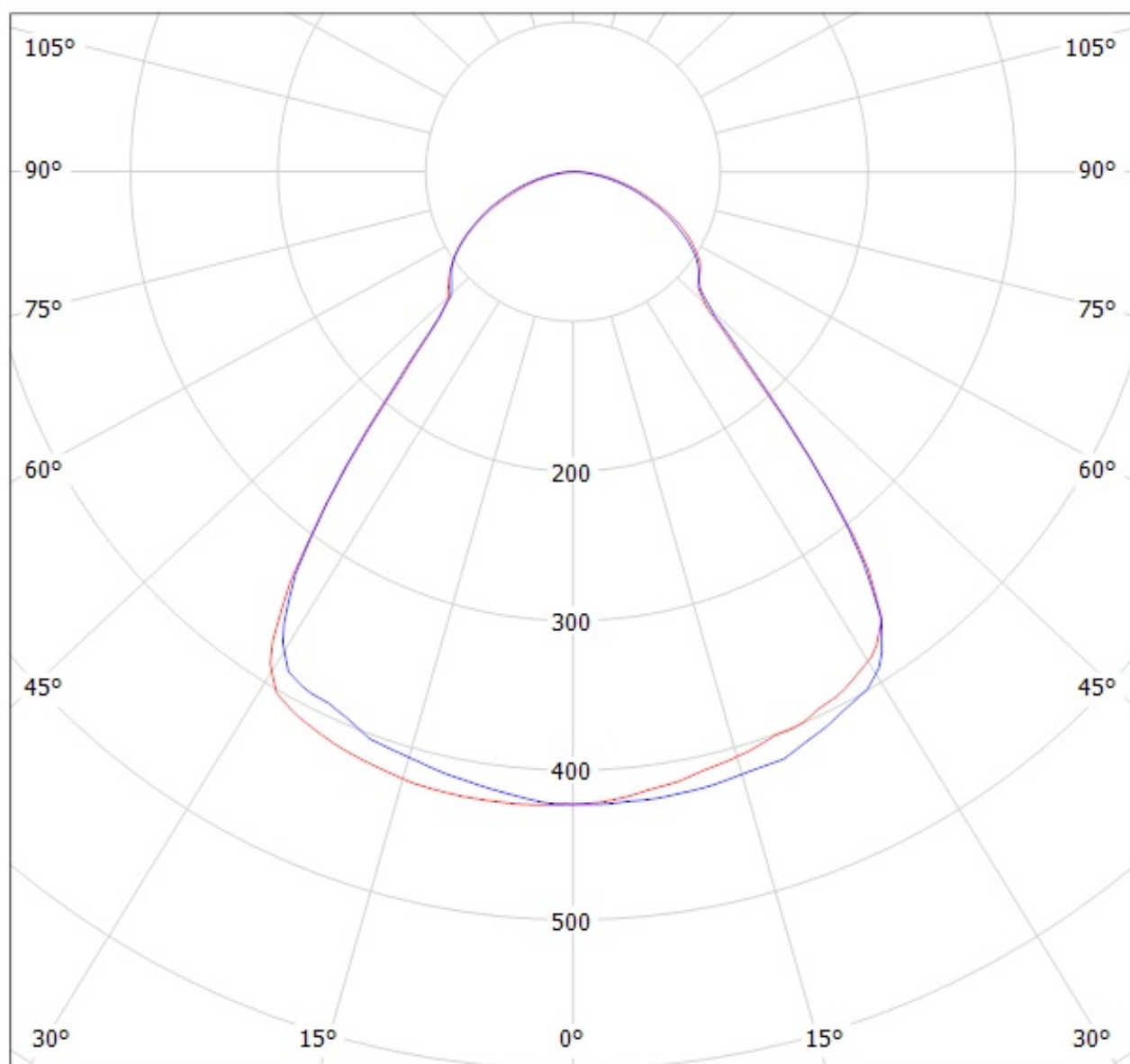

cd/klm

— C0 - C180 — C90 - C270

Luminaire: Ledil C12469_LISA2-R-PIN_(Z8Y19)

Lamps: 1 x Seoul_Z8Y19_111.337lm@250mA_P=0.7402W_η=0.25

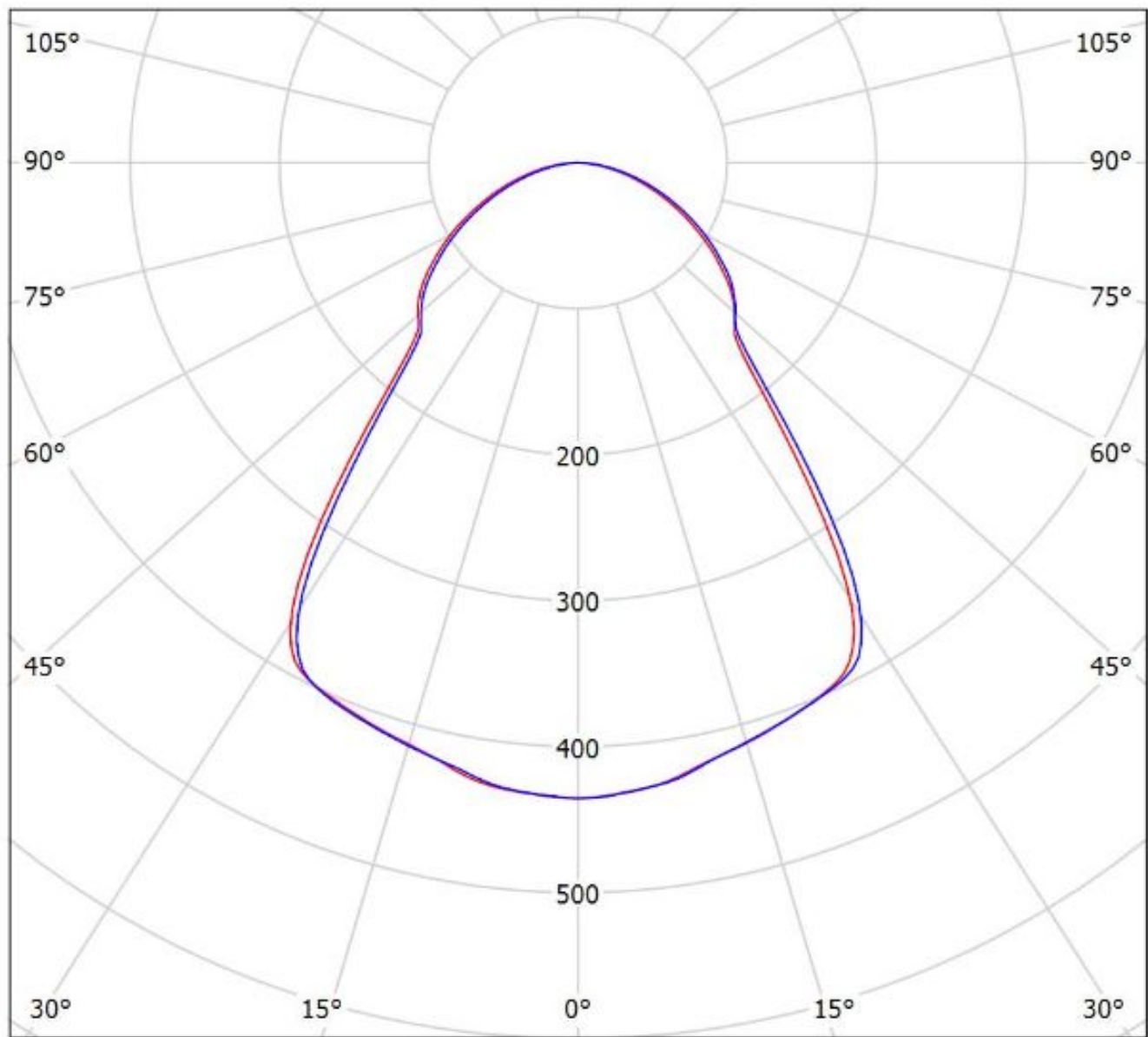

cd/klm

— C0 - C180

— C90 - C270

η = 86%

Luminaire: Ledil C12469_LISA2-R-PIN_(Z8Y15)

Lamps: 1 x Seoul_Z8Y15_99.8967lm@250mA_P=0.7569W_I=0.25A

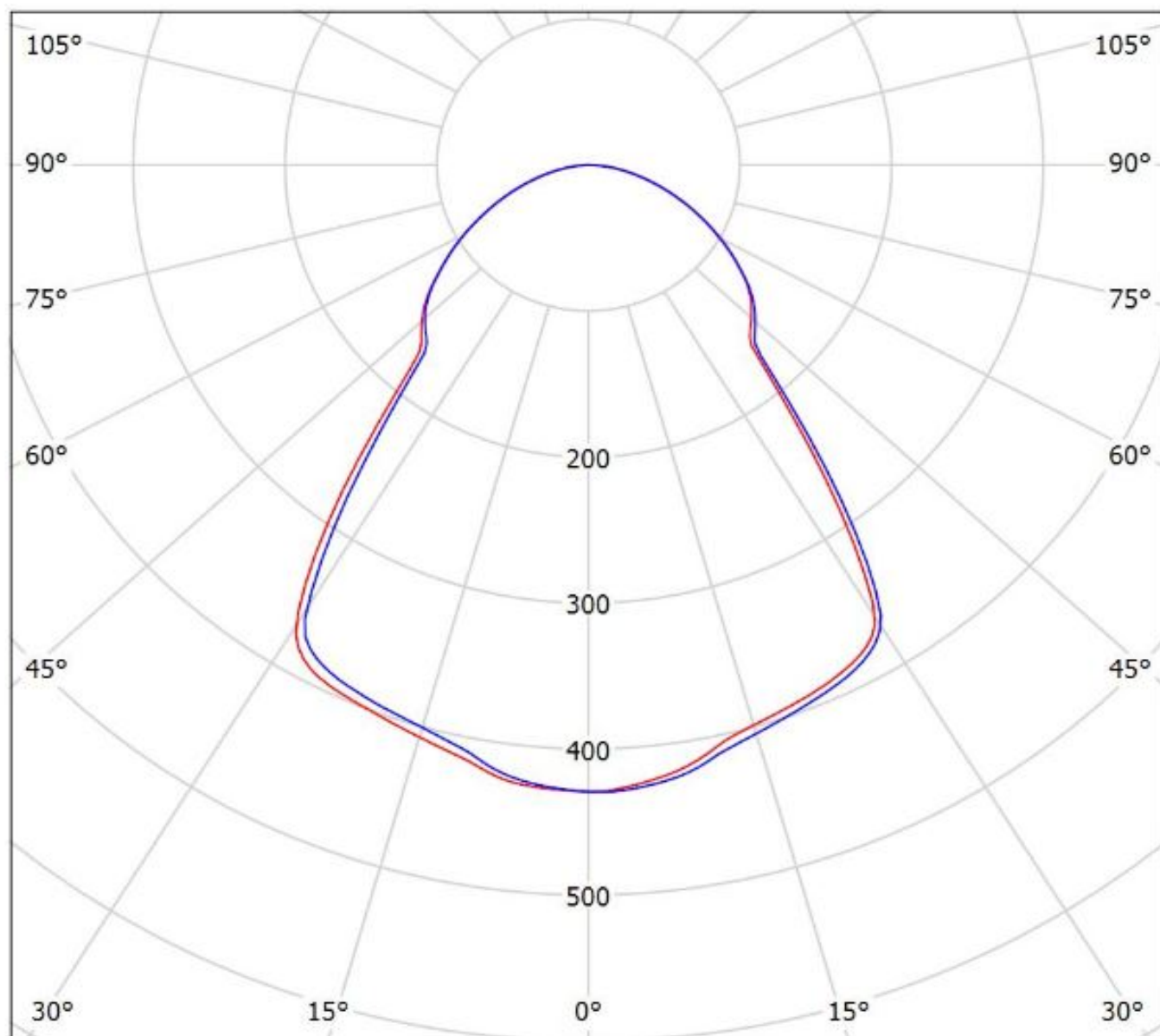

cd/klm

— C0 - C180

— C90 - C270

$\eta = 87\%$

NOTE: The typical divergence will be changed by different color, chip size and chip position tolerance. The typical total divergence is the full angle measured where the luminous intensity is half of the peak value.