

## 150V N-Channel Enhancement Mode Power MOSFET

### Description

WMM071N15HG2 uses Wayon's 2<sup>nd</sup> generation power trench MOSFET technology that has been especially tailored to minimize the on-state resistance and yet maintain superior switching performance. This device is well suited for high efficiency fast switching applications.

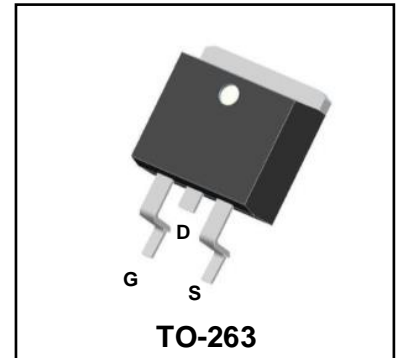

### Features

- $V_{DS} = 150V$ ,  $I_D = 135A$   
 $R_{DS(on)} < 7.1m\Omega @ V_{GS} = 10V$
- High Speed Power Switching
- Low Gate Charge
- Low  $R_{DS(on)}$
- 100% EAS Guaranteed

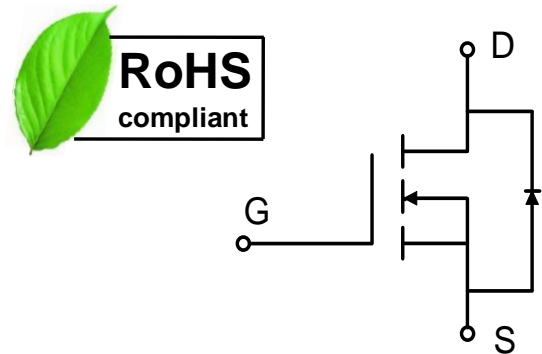

### Applications

- Synchronous Rectification in SMPS
- Hard Switching and High Speed Circuit
- UPS
- Motor Control
- Power Tools

### Absolute Maximum Ratings

Parameter	Symbol	Value	Unit
Drain-Source Voltage	$V_{DS}$	150	V
Gate-Source Voltage	$V_{GS}$	$\pm 20$	V
Continuous Drain Current <sup>1</sup>	$I_D$	$T_C = 25^\circ C$	135
		$T_C = 100^\circ C$	96
Pulsed Drain Current <sup>2</sup>	$I_{DM}$	430	A
Single Pulse Avalanche Energy <sup>3</sup>	<b>EAS</b>	180	mJ
Avalanche Current	$I_{AS}$	60	A
Total Power Dissipation <sup>4</sup>	$P_D$	306	W
Operating Junction and Storage Temperature Range	$T_J, T_{STG}$	-55 to 175	$^\circ C$

### Thermal Characteristics

Parameter	Symbol	Value	Unit
Thermal Resistance from Junction-to-Ambient <sup>1</sup>	$R_{\theta JA}$	59.5	$^\circ C/W$
Thermal Resistance from Junction-to-Case <sup>1</sup>	$R_{\theta JC}$	0.49	

**Electrical Characteristics**  $T_c = 25^\circ\text{C}$ , unless otherwise noted

Parameter	Symbol	Test Conditions	Min.	Typ.	Max.	Unit
<b>Static Characteristics</b>						
Drain-Source Breakdown Voltage	$V_{(BR)DSS}$	$V_{GS} = 0V, I_D = 250\mu A$	150	-	-	V
Gate-body Leakage current	$I_{GSS}$	$V_{DS} = 0V, V_{GS} = \pm 20V$	-	-	$\pm 100$	nA
Zero Gate Voltage Drain Current	$T_J=25^\circ\text{C}$	$V_{DS} = 150V, V_{GS} = 0V$	-	-	1	$\mu A$
	$T_J=100^\circ\text{C}$		-	-	100	
Gate-Threshold Voltage	$V_{GS(th)}$	$V_{DS} = V_{GS}, I_D = 250\mu A$	2	3	4	V
Drain-Source on-Resistance <sup>2</sup>	$R_{DS(on)}$	$V_{GS} = 10V, I_D = 20A$	-	6.2	7.1	m $\Omega$
Forward Transconductance <sup>2</sup>	$g_{fs}$	$V_{DS} = 5V, I_D = 20A$	-	76	-	S
<b>Dynamic Characteristics</b>						
Input Capacitance	$C_{iss}$	$V_{DS} = 75V, V_{GS} = 0V, f = 1\text{MHz}$	-	5470	-	pF
Output Capacitance	$C_{oss}$		-	389	-	
Reverse Transfer Capacitance	$C_{rss}$		-	13	-	
<b>Switching Characteristics</b>						
Gate Resistance	$R_g$	$V_{DS}=0V, V_{GS}=0V, f=1\text{MHz}$	-	2.75	-	$\Omega$
Total Gate Charge	$Q_g$	$V_{GS} = 10V, V_{DS} = 75V, I_D = 20A$	-	65	-	nC
Gate-Source Charge	$Q_{gs}$		-	20.5	-	
Gate-Drain Charge	$Q_{gd}$		-	8.8	-	
Turn-on Delay Time	$t_{d(on)}$	$V_{GS} = 10V, V_{DS} = 75V, R_G = 10\Omega, I_D = 20A$	-	23.5	-	nS
Rise Time	$t_r$		-	21.5	-	
Turn-off Delay Time	$t_{d(off)}$		-	33	-	
Fall Time	$t_f$		-	14.5	-	
<b>Drain-Source Body Diode Characteristics</b>						
Diode Forward Voltage <sup>2</sup>	$V_{SD}$	$I_S = 1A, V_{GS} = 0V$	-	-	1.0	V
Continuous Source Current <sup>1,5</sup>	$I_S$	$V_G = V_D = 0V, \text{Force Current}$	-	-	135	A
Body Diode Reverse Recovery Time	$t_{rr}$	$V_R = 75V, I_F = 20A, \text{di/dt} = 100A/\mu s$	-	76	-	nS
Body Diode Reverse Recovery Charge	$Q_{rr}$		-	151	-	nC

## Notes:

- The data tested by surface mounted on a 1 inch<sup>2</sup> FR-4 board with 2OZ copper.
- The data tested by pulsed , pulse width  $\leq 300\mu s$  , duty cycle  $\leq 2\%$
- The EAS data shows Max. rating . The test condition is  $V_{DD}=25V, V_{GS}=10V, L=0.1\text{mH}, I_{AS}=60A$
- The power dissipation is limited by  $175^\circ\text{C}$  junction temperature
- The data is theoretically the same as  $I_D$  and  $I_{DM}$  , in real applications , should be limited by total power dissipation.

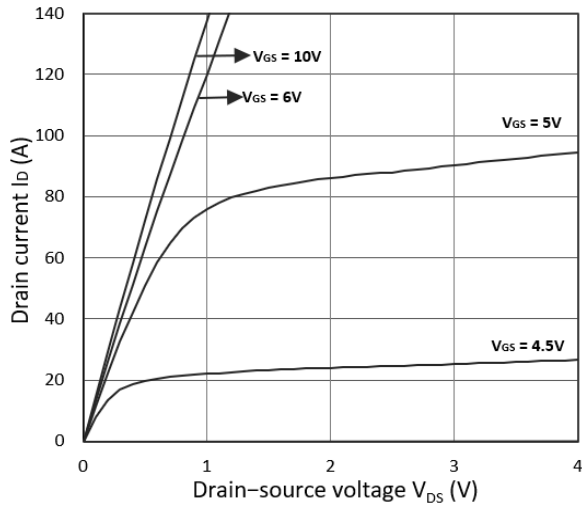

Figure 1. Output Characteristics

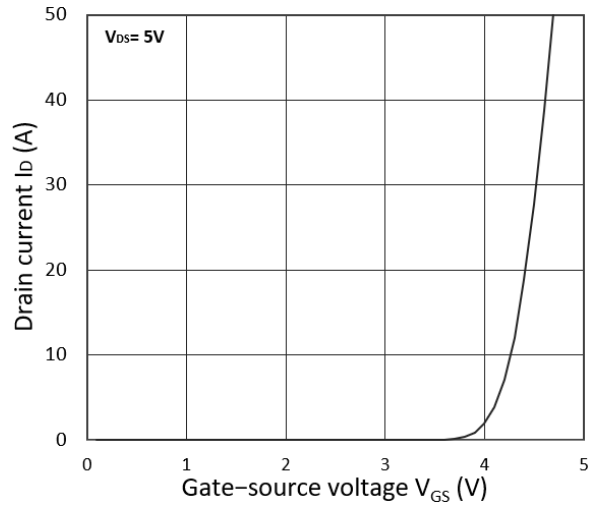

Figure 2. Transfer Characteristics

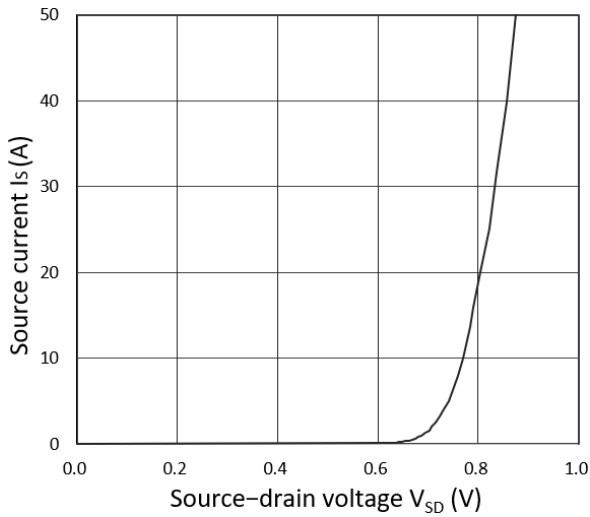

Figure 3. Forward Characteristics of Reverse

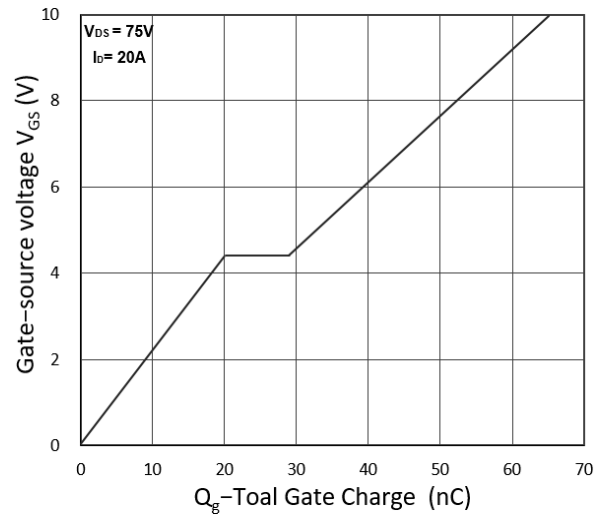

Figure 4. Gate Charge Characteristics

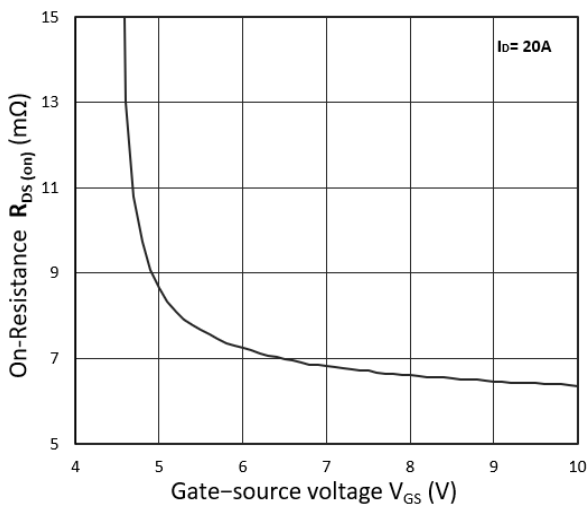

Figure 5.  $R_{DS(ON)}$  vs.  $V_{GS}$

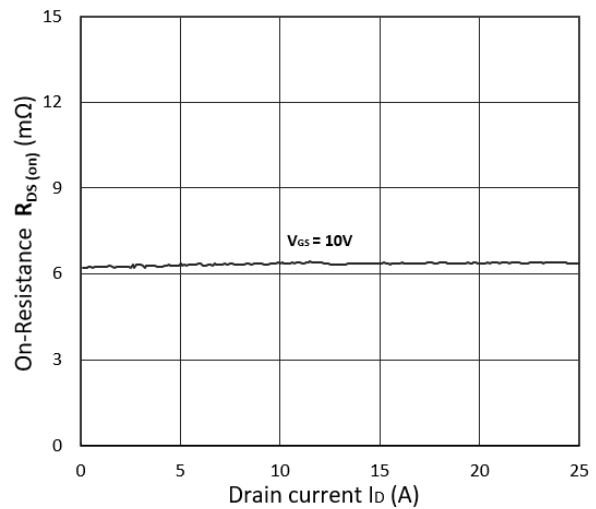

Figure 6.  $R_{DS(ON)}$  vs.  $I_D$

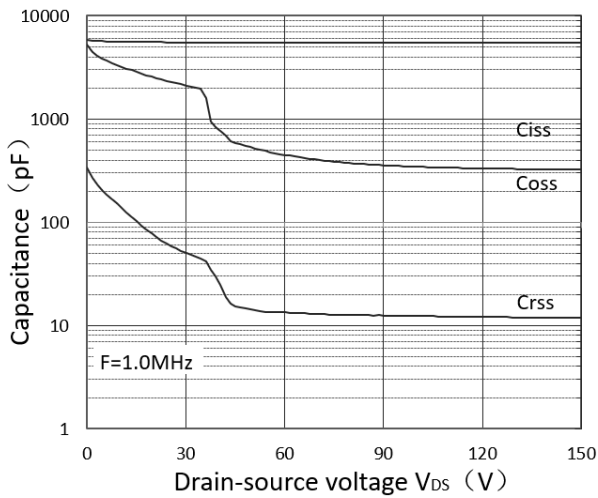

Figure 7. Capacitance Characteristics

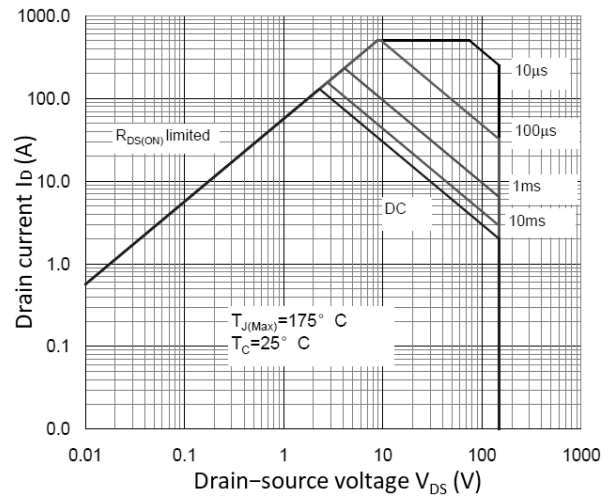

Figure 8. Safe Operating Area

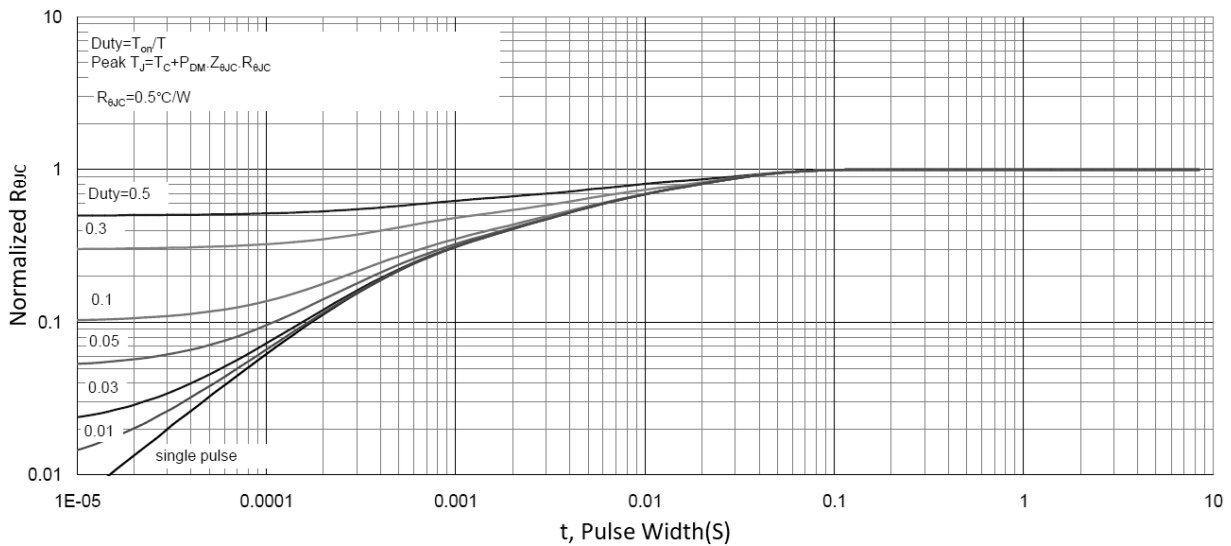

Figure 9. Normalized Maximum Transient Thermal Impedance

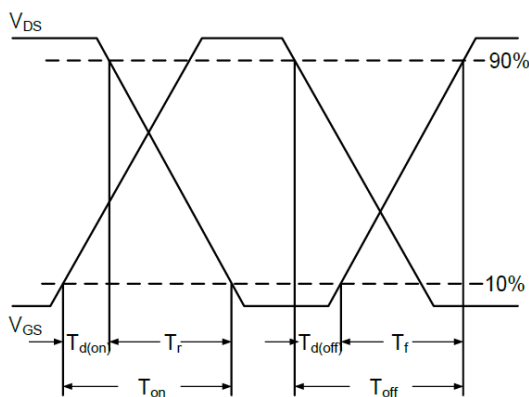

Figure 10. Switching Time Waveform

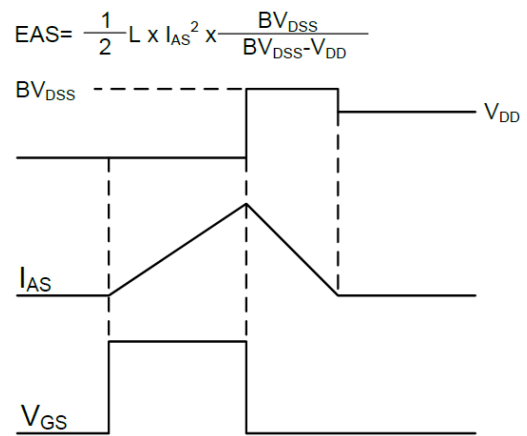
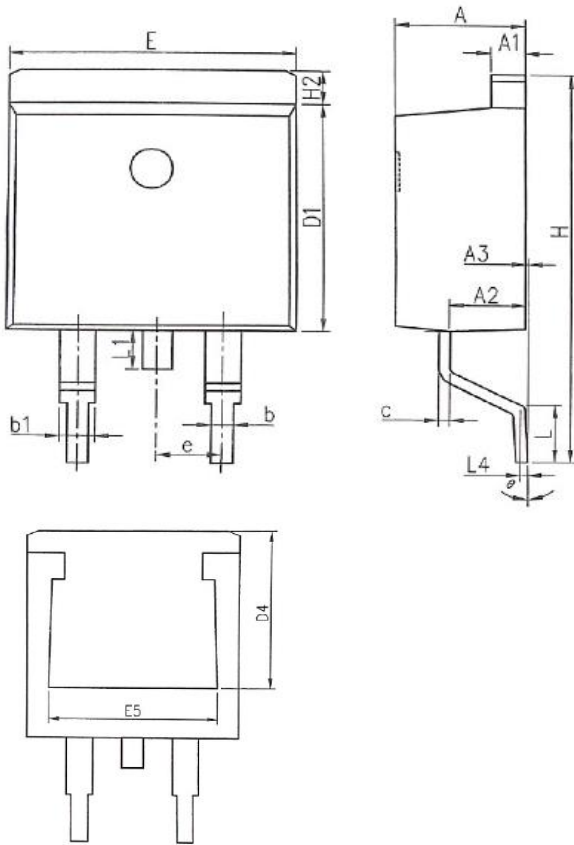

Figure 11. Unclamped Inductive Switching Waveform

## Mechanical Dimensions for TO-263



## COMMON DIMENSIONS

SYMBOL	MM	
	MIN	MAX
A	4.064	4.826
A1	1.143	1.651
A2	2.49	2.89
A3	0.00	0.254
b	0.508	0.991
b1	1.143	1.778
c	0.381	0.737
D1	8.382	9.652
D4	6.858	-
E	9.652	10.668
E5	6.223	-
e	2.540BSC	
H	14.605	15.875
H2	-	1.676
L	1.778	2.794
L1	-	1.778
L4	0.254BSC	
$\theta$	0°	8°

## Ordering Information

Part	Package	Marking	Packing method
WMM071N15HG2	TO-263	WMM071N15HG2	Tape and Reel

## Marking Information

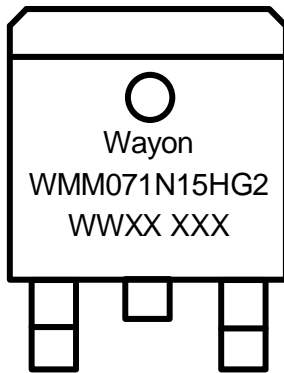

WMM071N15HG2 = Device code

WWXX XXX= Date code

## Contact Information

No.1001, Shiwan(7) Road, Pudong District, Shanghai, P.R.China.201207

Tel: 86-21-50310888 Fax: 86-21-50757680 Email: market@way-on.com

WAYON website: <http://www.way-on.com>

For additional information, please contact your local Sales Representative.

® is registered trademarks of Wayon Corporation.

## Disclaimer

WAYON reserves the right to make changes without further notice to any Products herein to improve reliability, function, or design. The Products are not designed for use in hostile environments, including, without limitation, aircraft, nuclear power generation, medical appliances, and devices or systems in which malfunction of any Product can reasonably be expected to result in a personal injury. The information given in this document shall in no event be regarded as a guarantee of conditions or characteristics. WAYON does not assume any liability for infringement of patents, copyrights, or other intellectual property rights of third parties by or arising from the use of Products or technical information described in this document.