

Data sheet

Commercial Art.No.: 25.191.0853.0

Printed circuit board terminal 8192 / 8 OB

PCB terminal with screw connection with rising cage clamp system, 8 poles, with solder pin (3.5mm), max. cross section: 2.5 mm², pitch: 5 mm, type of packing: carton, color: grey

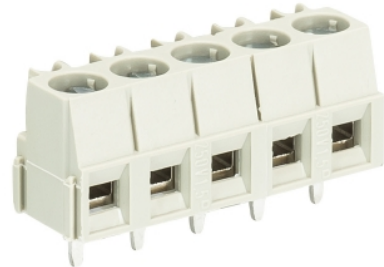

Commercial Art.No.	25.191.0853.0
EAN	4015573178892
Order Unit	50

Certificates / Approvals



Technical data

General

Modular spacing	5 mm
Connection type	screw connection
Soldering process	Wave soldering
Packaging	Carton
Number of poles	8
Conductor to circuit board	180°
Number of levels	1
Integrated test socket	yes
Insulation plate	No
Retaining pins	No
Marking	No

Technical data

Nominal cross section	1.5 mm ²
Rated current	10 A
Overvoltage Category I	1000 V
Overvoltage Category II	690 V
Overvoltage Category III	250 V
Rated impulse voltage	4 kV
Wire strip length	6 mm

Connection Data

Minimum cross section solid	0.14 mm ²
Maximum cross section solid	2.5 mm ²
Minimum cross section fine stranded	0.14 mm ²
Maximum cross section fine stranded	1.5 mm ²

Wire strip length	6 mm
-------------------	------

Technical Data UL/CSA

Cross section UL	30-14 AWG
Voltage UL	300 V
Current field wiring	15 A
Current factory wiring	16 A
Cross section CSA	30-14 AWG
Voltage CSA	300 V
Current CSA	15 A

Other

Type of insulation material	Thermoplastic
Color	Grey
Height	10 mm
Length	40.55 mm
Depth	8.2 mm
Material attachment screw	Steel
Material contact base	CuSn
Material contact surface	Sn
Tightening torque note	If soldered additional mechanical fixing necessary

Classification

ECLASS 11	
ECLASS 8.1	27440401
ETIM 7.0	EC002643
ETIM 6.0	EC002643
ETIM 5.0	EC002643
ETIM 4.0	EC002643

Product compliance

ROHS conformity status	Compliant/Exempted
ROHS exceptions	III-6(c)
REACH-SVHC conformity status	Duty-To-Declare
REACH-SVHC substances	Lead
REACH-SVHC CAS numbers	7439-92-1

Gezeichnete Ausführung:

drawn version

25.191.1053.F

These dimensions will be especially checked at delivery
Only inspection dimensions
With /E marked dimensions are only valid for internal use

Diese Maße werden bei Abnahme besonders geprüft
Ausschließlich Prüfmaße
Mit /E gekennzeichnete Maße sind nur für interne Zwecke gültig

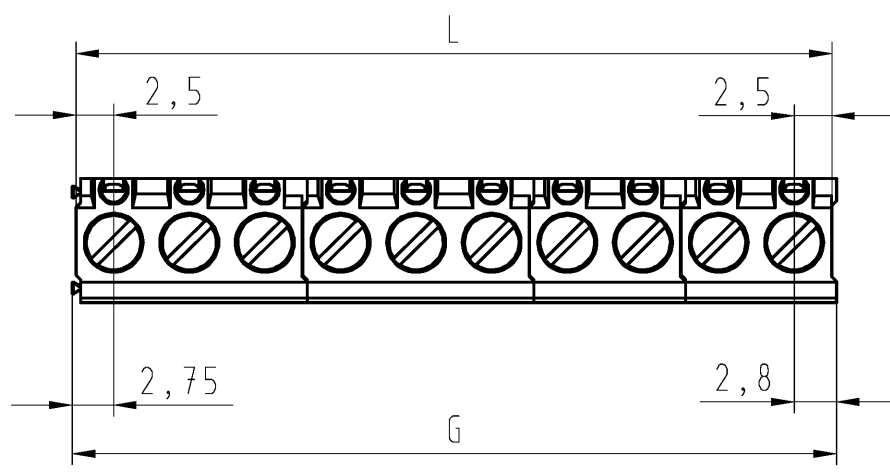
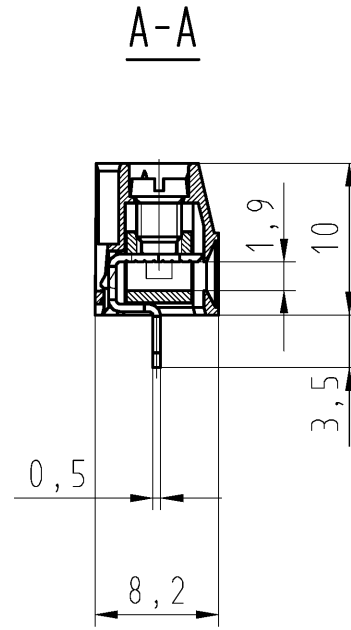
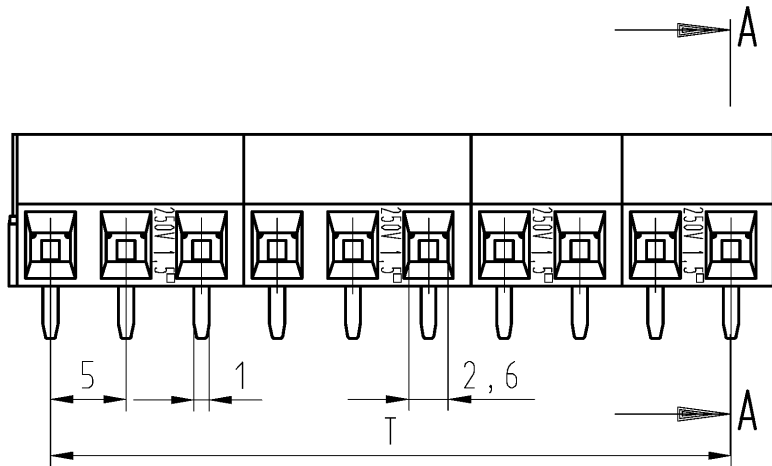

25.191.2453.F	8192/24 OB	24	115	120	120,55
25.191.2353.F	8192/23 OB	23	110	115	115,55
25.191.2253.F	8192/22 OB	22	105	110	110,55
25.191.2153.F	8192/21 OB	21	100	105	105,55
25.191.2053.F	8192/20 OB	20	95	100	100,55
25.191.1953.F	8192/19 OB	19	90	95	95,55
25.191.1853.F	8192/18 OB	18	85	90	90,55
25.191.1753.F	8192/17 OB	17	80	85	85,55
25.191.1653.F	8192/16 OB	16	75	80	80,55
25.191.1553.F	8192/15 OB	15	70	75	75,55
25.191.1453.F	8192/14 OB	14	65	70	70,55
25.191.1353.F	8192/13 OB	13	60	65	65,55
25.191.1253.F	8192/12 OB	12	55	60	60,55
25.191.1153.F	8192/11 OB	11	50	55	55,55
25.191.1053.F	8192/10 OB	10	45	50	50,55
25.191.0953.F	8192/ 9 OB	9	40	45	45,55
25.191.0853.F	8192/ 8 OB	8	35	40	40,55
25.191.0753.F	8192/ 7 OB	7	30	35	35,55
25.191.0653.F	8192/ 6 OB	6	25	30	30,55
25.191.0553.F	8192/ 5 OB	5	20	25	25,55
25.191.0453.F	8192/ 4 OB	4	15	20	20,55
25.191.0353.F	8192/ 3 OB	3	10	15	15,55
25.191.0253.F	8192/ 2 OB	2	5	10	10,55

Teile-Nr. part-no.	Typ type	Polzahl poles	T	L	G
-----------------------	-------------	------------------	---	---	---

.F	Farbe/colour
.0	grau/grey
.1	schwarz/black
.5	rot/red

Weitere Daten siehe Katalog
further data see catalog

Tolerierung Size ISO 14405 (E)/Tolerance system Size ISO 14405 (E). (This ISO-standard describes the envelope principle. According to the envelope principle the deviations of form and parallelism are limited by the size tolerances).		ja/yes <input checked="" type="checkbox"/> Stoffverbots- und Deklarationsliste nach WN 5020.010 ist einzuhalten. Conformity with Wieland document WN 5020.010 e (list of prohibited / declarable hazardous substances) to be declared!	
Freitoleranz nach DIN ISO 2768 - m General tolerance		CAD - Zeichnung, keine manuellen Änderungen CAD - drawing, no manual modifications allowed	
1.Verwendung: First Use:		Blatt: 1 von 1 Sheet: 1 of 1	
Werkstoff/Material		2015 gezeichnet drawn 11.02 Hoffmann Th.	Name
Maßstab/Scale 2:1		T 25.191.0253.0 01K	
Vol. mm ³ OfI./Surf. mm ²		Ersatz für/Replacement for: -	
www.wieland-electric.com		Type 8192/2-24 OB	Benennung/Title LP_KLEMME PCB-terminal 250V / 10A / 1,5mm ²
Index	Datum / Blatt Date / Sheet	Maße in mm/Dimensions are in mm	
Änderung/Revision			