

Low-Voltage SPDT Analog Switch or 2:1 Multiplexer / De-multiplexer Bus Switch

NC7SB3157, FSA3157

Description

The NC7SB3157 / FSA3157 is a high-performance, single-pole / double-throw (SPDT) analog switch or 2:1 multiplexer / de-multiplexer bus switch.

The device is fabricated with advanced sub-micron CMOS technology to achieve high-speed enable and disable times and low on resistance. The break-before-make select circuitry prevents disruption of signals on the B Port due to both switches temporarily being enabled during select pin switching. The device is specified to operate over the 1.65 to 5.5 V V_{CC} operating range. The control input tolerates voltages up to 5.5 V, independent of the V_{CC} operating range.

Features

- Useful in Both Analog and Digital Applications
- Space-Saving, SC70 6-Lead Surface Mount Package
- Ultra-Small, MicroPak™ Leadless Package
- Low On Resistance: < 10 Ω on Typical at 3.3 V V_{CC}
- Broad V_{CC} Operating Range: 1.65 V to 5.5 V
- Rail-to-Rail Signal Handling
- Power-Down, High-Impedance Control Input
- Over-Voltage Tolerance of Control Input to 7.0 V
- Break-Before-Make Enable Circuitry
- 250 MHz, 3 dB Bandwidth
- These Devices are Pb-Free, Halogen Free/BFR Free and are RoHS Compliant

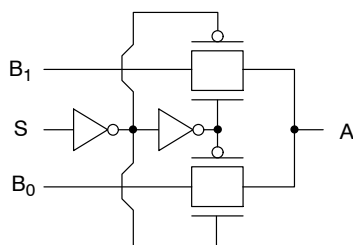
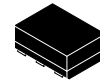
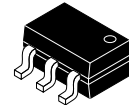

Figure 1. Logic Symbol

SIP6
CASE 127EB



SC-88 (SC-70 6 Lead)
CASE 419AD-01



MARKING DIAGRAM

SIP6

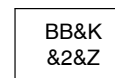

- BB = Specific Device Code
- &K = Lot Code
- &2 = Date Code (Year and Week)
- &Z = Assembly Location

SC-88

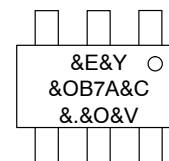

- &E = Designates Space
- &Y = Date Code (Year)
- &O = Plant Code
- B7A = Specific Device Code
- &C = Die Run Code
- &. = Pin 1 Dot
- &V = Date (Week)

ORDERING INFORMATION

See detailed ordering and shipping information on page 8 of this data sheet.

NC7SB3157, FSA3157

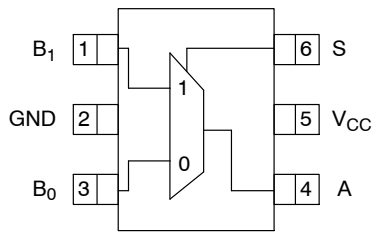

Figure 2. Pin Assignments SC70

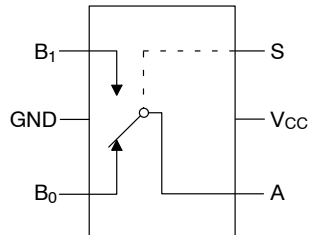

Figure 3. Analog Symbol

FUNCTION TABLE

Input (S)	Function
Logic Level Low	B ₀ Connected to A
Logic Level High	B ₁ Connected to A

PIN DESCRIPTIONS

Pin Names	Description
A, B ₀ , B ₁	Data Ports
S	Control Input

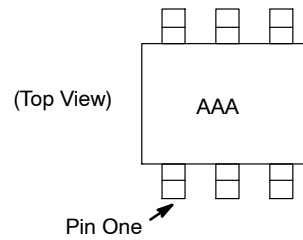

Figure 4. Pin One Orientation

NOTE: Orientation of top mark determines pin one location. Read the top product code mark left to right and pin one is the lower left pin (see Figure 4).

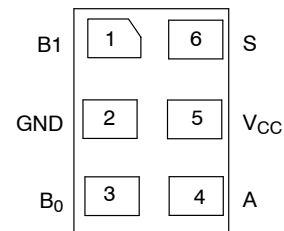

Figure 5. Pad Assignments for MicroPak

ABSOLUTE MAXIMUM RATINGS

Symbol	Parameter	Min.	Max.	Unit
V _{CC}	Supply Voltage	-0.5	+7.0	V
V _S	DC Switch Voltage (Note 1)	-0.5	V _{CC} +0.5	V
V _{IN}	DC Input Voltage (Note 1)	-0.5	+7.0	V
I _{IK}	DC Input Diode Current at V _{IN} < 0 V	-	-50	mA
I _{OUT}	DC Output Current	-	128	mA
I _{CC} /I _{GND}	DC V _{CC} or Ground Current	-	±100	mA
T _{STG}	Storage Temperature Range	-65	+150	°C
T _J	Junction Temperature Under Bias	-	+150	°C
T _L	Junction Lead Temperature (Soldering, 10 seconds)	-	+260	°C
MSL	Moisture Sensitivity Level (JEDEC J-STD-020A)	-	1	Level
P _D	Power Dissipation at +85°C	-	180	mW
ESD	Human Body Model, JESD22-A114	-	4000	V

Stresses exceeding those listed in the Maximum Ratings table may damage the device. If any of these limits are exceeded, device functionality should not be assumed, damage may occur and reliability may be affected.

1. The input and output negative voltage ratings may be exceeded if the input and output diode current ratings are observed.

RECOMMENDED OPERATING CONDITIONS

Symbol	Parameter	Min	Max	Unit	
V _{CC}	Supply Voltage Operating	1.65	5.50	V	
V _{IN}	Control Input Voltage (Note 2)	0	V _{CC}	V	
V _{IN}	Switch Input Voltage (Note 2)	0	V _{CC}	V	
V _{OUT}	Output Voltage (Note 2)	0	V _{CC}	V	
T _A	Operating Temperature	-40	+85	°C	
f _r , t _f	Input Rise and Fall Time	Control Input V _{CC} = 2.3 V – 3.6 V	0	10	ns/V
		Control Input V _{CC} = 4.5 V – 5.5 V	0	5	ns/V
θ _{JA}	Thermal Resistance, SC70	-	270	°C/W	

Functional operation above the stresses listed in the Recommended Operating Ranges is not implied. Extended exposure to stresses beyond the Recommended Operating Ranges limits may affect device reliability.

2. Control input must be held HIGH or LOW; it must not float.

NC7SB3157, FSA3157

DC ELECTRICAL CHARACTERISTICS

Symbol	Parameter	Conditions	V _{CC} (V)	T _A = +25°C			T _A = -40°C to +85°C		Unit
				Min.	Typ.	Max.	Min.	Max.	
V _{IH}	High Level Input Voltage		1.65–1.95	0.75 V _{CC}	–	–	0.75 V _{CC}	–	V
			2.3–5.5	0.7 V _{CC}	–	–	0.7 V _{CC}	–	V
V _{IL}	Low Level Input Voltage		1.65–1.95	–	–	0.25 V _{CC}	–	0.25 V _{CC}	V
			2.3–5.5	–	–	0.3 V _{CC}	–	0.3 V _{CC}	V
I _{IN}	Input Leakage Current	0 ≤ V _{IN} ≤ 5.5 V	0–5.5	–	±0.05	±0.1	–	±1	μA
I _{OFF}	Off State Leakage Current	0 ≤ A, B ≤ V _{CC}	1.65–5.5	–	±0.05	±0.1	–	±1	μA
R _{ON}	Switch On Resistance (Note 3)	V _{IN} = 0 V, I _O = 30 mA	4.5	–	3.0	7.0	–	7.0	Ω
		V _{IN} = 2.4 V, I _O = -30 mA	4.5	–	5.0	12.0	–	12.0	
		V _{IN} = 4.5 V, I _O = -30 mA	4.5	–	7.0	15.0	–	15.0	
		V _{IN} = 0 V, I _O = 24 mA	3.0	–	4.0	9.0	–	9.0	
		V _{IN} = 3 V, I _O = -24 mA	3.0	–	10.0	20.0	–	20.0	
		V _{IN} = 0 V, I _O = 8 mA	2.3	–	5.0	12.0	–	12.0	
		V _{IN} = 2.3 V, I _O = -8 mA	2.3	–	13.0	30.0	–	30.0	
		V _{IN} = 0 V, I _O = 4 mA	1.65	–	6.5	20.0	–	20.0	
I _{CC}	Quiescent Supply Current; All Channels On or Off	V _{IN} = V _{CC} or GND I _{OUT} = 0	5.5	–	–	1	–	10	μA
		Analog Signal Range	V _{CC}	0	–	V _{CC}	0	V _{CC}	V
R _{RANGE}	On Resistance Over Signal Range (Note 3, 7)	I _A = -30 mA, 0 ≤ V _{Bn} ≤ V _{CC}	4.5	–	–	–	–	25.0	Ω
		I _A = -24 mA, 0 ≤ V _{Bn} ≤ V _{CC}	3.0	–	–	–	–	50.0	
		I _A = -8 mA, 0 ≤ V _{Bn} ≤ V _{CC}	2.3	–	–	–	–	100	
		I _A = -4 mA, 0 ≤ V _{Bn} ≤ V _{CC}	1.65	–	–	–	–	300	
ΔR _{ON}	On Resistance Match Between Channels (Note 3, 4, 5)	I _A = -30 mA, V _{Bn} = 3.15	4.5	–	0.15	–	–	–	Ω
		I _A = -24 mA, V _{Bn} = 2.1	3.0	–	0.2	–	–	–	
		I _A = -8 mA, V _{Bn} = 1.6	2.3	–	0.5	–	–	–	
		I _A = -4 mA, V _{Bn} = 1.15	1.65	–	0.50	–	–	–	
R _{flat}	On Resistance Flatness (Note 3, 4, 6)	I _A = -30 mA, 0 ≤ V _{Bn} ≤ V _{CC}	5.0	–	6.0	–	–	–	Ω
		I _A = -24 mA, 0 ≤ V _{Bn} ≤ V _{CC}	3.3	–	12.0	–	–	–	
		I _A = -8 mA, 0 ≤ V _{Bn} ≤ V _{CC}	2.5	–	28.0	–	–	–	
		I _A = -4 mA, 0 ≤ V _{Bn} ≤ V _{CC}	1.8	–	125	–	–	–	

Product parametric performance is indicated in the Electrical Characteristics for the listed test conditions, unless otherwise noted. Product performance may not be indicated by the Electrical Characteristics if operated under different conditions.

3. Measured by the voltage drop between A and B pins at the indicated current through the switch. On resistance is determined by the lower of the voltages on the two (A or B Ports).
4. Parameter is characterized, but not tested in production.
5. ΔR_{ON} = R_{ON} max – R_{ON} minimum measured at identical V_{CC}, temperature, and voltage levels.
6. Flatness is defined as the difference between the maximum and minimum value of on resistance over the specified range of conditions.
7. Guaranteed by design.

NC7SB3157, FSA3157

AC ELECTRICAL CHARACTERISTICS

Symbol	Parameter	Conditions	V _{CC} (V)	T _A = +25°C			T _A = -40°C to +85°C		Unit	Figure Number
				Min.	Typ.	Max.	Min.	Max.		
t _{PHL} , t _{PLH}	Propagation Delay Bus-to-Bus (Note 8)	V _I = OPEN	1.65–1.95	–	–	3.5	–	3.5	ns	Figure 12 Figure 13
			2.3–2.7	–	–	1.2	–	1.2		
			3.0–3.6	–	–	0.8	–	0.8		
			4.5–5.5	–	–	0.3	–	0.3		
t _{PZL} , t _{PZH}	Output Enable Time Turn-On Time (A to B _n)	V _I = 2 x V _{CC} for t _{PZL} V _I = 0 V for t _{PZH}	1.65–1.95	7.0	–	23.0	7.0	24.0	ns	Figure 12 Figure 13
			2.3–2.7	3.5	–	13.0	3.5	14.0		
			3.0–3.6	2.5	–	6.9	2.5	7.6		
			4.5–5.5	1.7	–	5.2	1.7	5.7		
t _{PLZ} , t _{PHZ}	Output Disable Time Turn-Off Time (A Port to B Port)	V _I = 2 x V _{CC} for t _{PLZ} V _I = 0 V for t _{PHZ}	1.65–1.95	3.0	–	12.5	3.0	13.0	ns	Figure 12 Figure 13
			2.3–2.7	2.0	–	7.0	2.0	7.5		
			3.0–3.6	1.5	–	5.0	1.5	5.3		
			4.5–5.5	0.8	–	3.5	0.8	3.8		
t _{B-M}	Break-Before-Make Time (Note 9)		1.65–1.95	0.5	–	–	0.5	–	ns	Figure 14
			2.3–2.7	0.5	–	–	0.5	–		
			3.0–3.6	0.5	–	–	0.5	–		
			4.5–5.5	0.5	–	–	0.5	–		
Q	Charge Injection (Note 9)	C _L = 0.1 nF, V _{GEN} = 0 V R _{GEN} = 0 Ω	5.0	–	7.0	–	–	–	pC	Figure 15
			3.3	–	3.0	–	–	–		
OIRR	Off Isolation (Note 10)	R _L = 50 Ω, f = 10 MHz	1.65–5.5	–	–57.0	–	–	–	dB	Figure 16
Xtalk	Crosstalk	R _L = 50 Ω, f = 10 MHz	1.65–5.5	–	–54.0	–	–	–	dB	Figure 17
BW	–3dB Bandwidth	R _L = 50 Ω	1.65–5.5	–	250	–	–	–	MHz	Figure 20
THD	Total Harmonic Distortion (Note 9)	R _L = 600 Ω, 0.5 V _{PP} , f = 600 Hz to 20 KHz	5.0	–	.011	–	–	–	%	–

8. This parameter is guaranteed by design but not tested. The bus switch contributes no propagation delay other than the RC delay of the on resistance of the switch and the 50 pF load capacitance, when driven by an ideal voltage source (zero output impedance).

9. Guaranteed by design.

10. Off Isolation = 20 log₁₀ [V_A / V_{Bn}].

CAPACITANCE (T_A = 25°C, f = 1 MHz Capacitance is characterized, but not tested in production.)

Symbol	Parameter	Conditions	Typ.	Max.	Unit	Figure Number
C _{IN}	Control Pin Input Capacitance	V _{CC} = 0 V	2.3	–	pF	–
C _{IO-B}	B Port Off Capacitance	V _{CC} = 5.0 V	6.5	–	pF	Figure 18
C _{IOA-ON}	A Port Capacitance When Switch Is Enabled	V _{CC} = 5.0 V	18.5	–	pF	Figure 19

TYPICAL PERFORMANCE CHARACTERISTICS

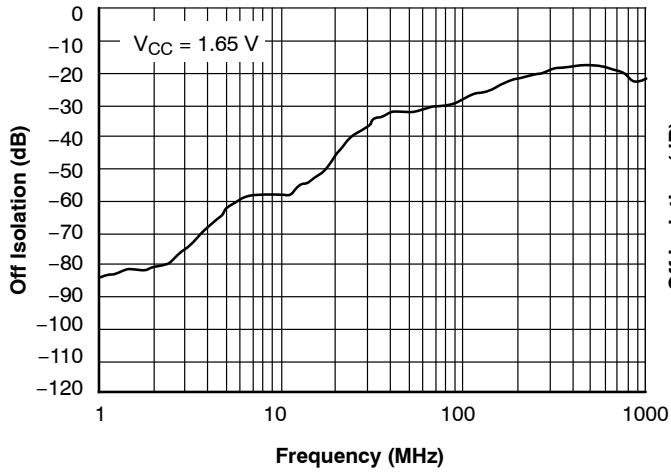

Figure 6. Off Isolation, $V_{CC} = 1.65\text{ V}$

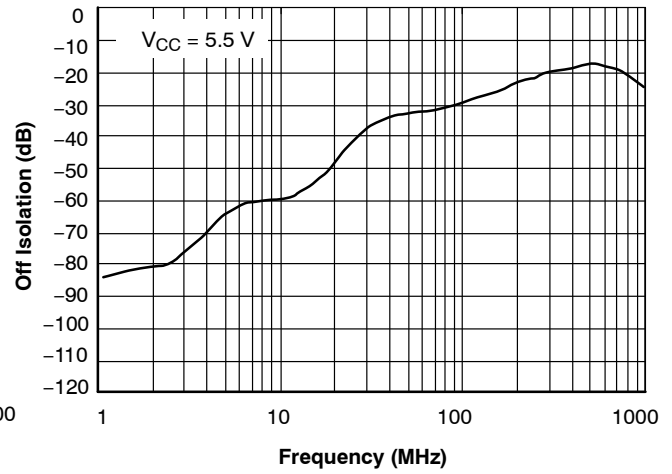

Figure 7. Off Isolation, $V_{CC} = 5.5\text{ V}$

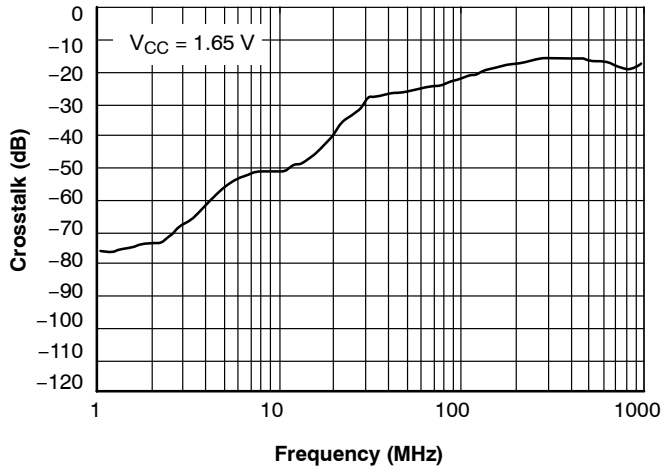

Figure 8. Crosstalk, $V_{CC} = 1.65\text{ V}$

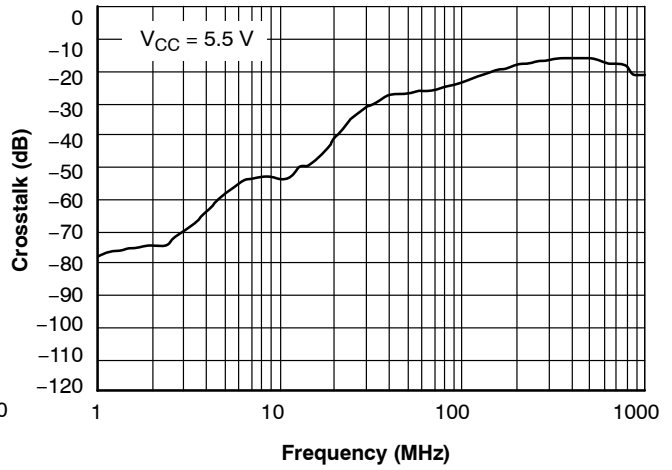

Figure 9. Crosstalk, $V_{CC} = 5.5\text{ V}$

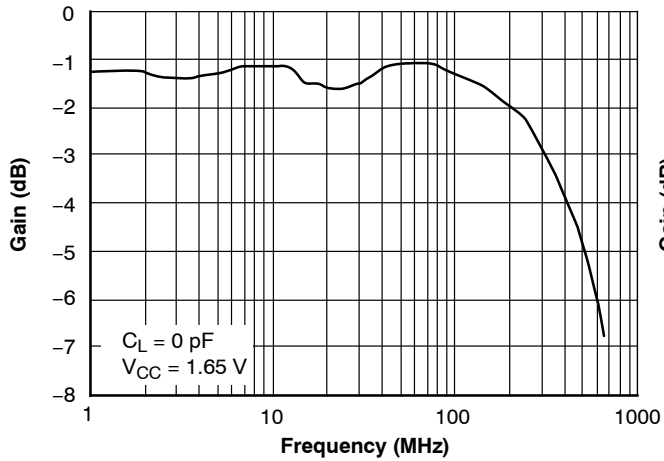

Figure 10. Bandwidth, $V_{CC} = 1.65\text{ V}$

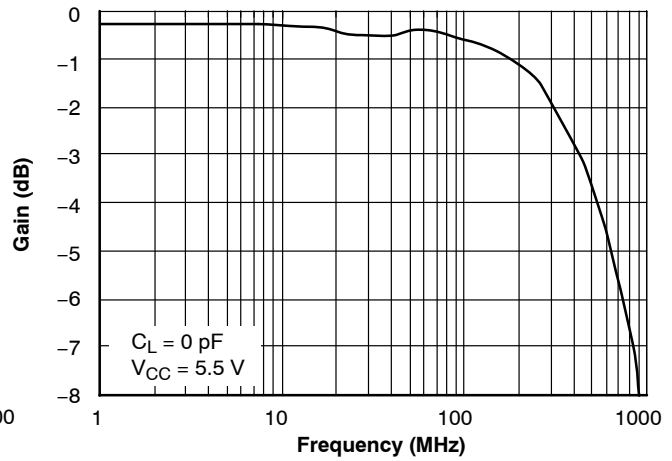
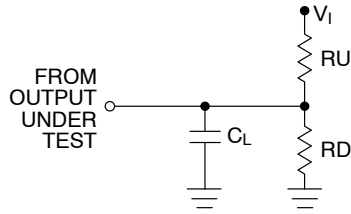

Figure 11. Bandwidth, $V_{CC} = 5.5\text{ V}$

NC7SB3157, FSA3157

AC LOADING AND WAVEFORMS



NOTE: Input driven by 50 Ω source terminated in 50 Ω CL includes load and stray capacitance
Input PRR = 1.0 MHz, $t_w = 500$ ns.

Figure 12. AC Test Circuit

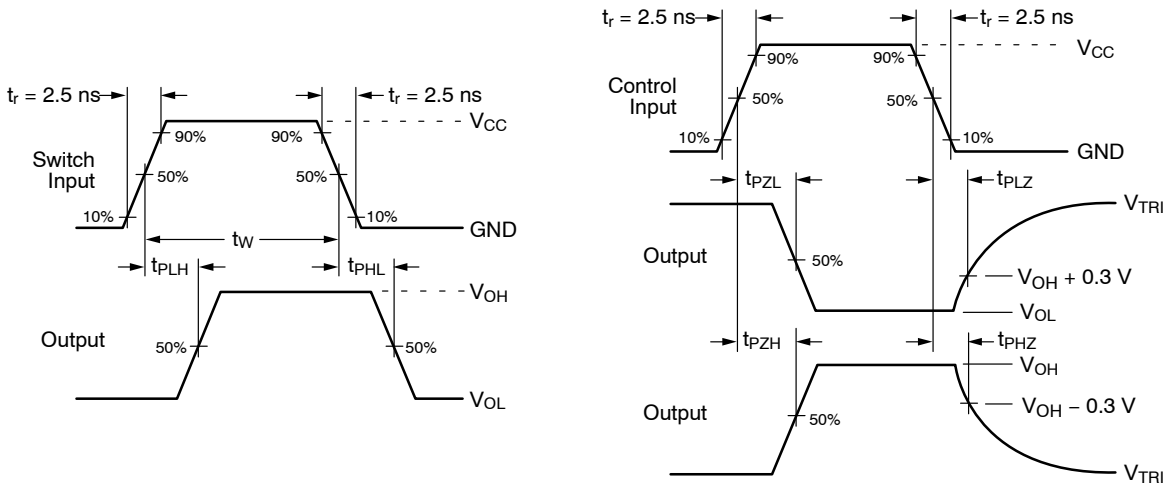

Figure 13. AC Waveforms

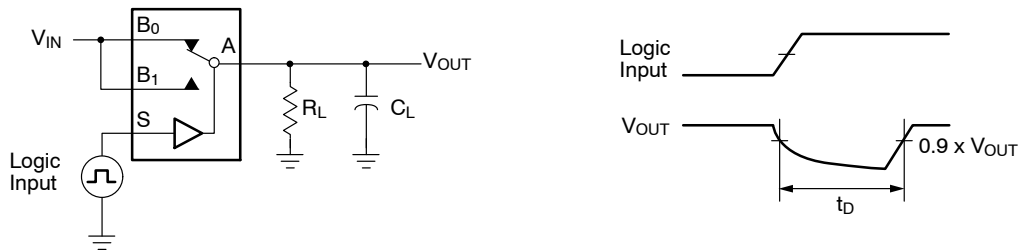

Figure 14. Break-Before-Make Interval Timing

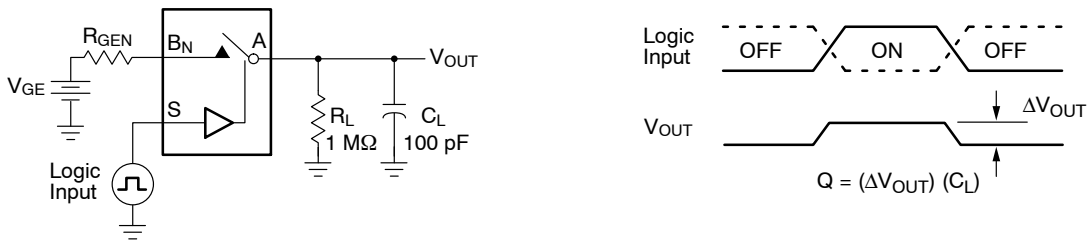

Figure 15. Charge Injection Test

NC7SB3157, FSA3157

AC LOADING AND WAVEFORMS (Continued)

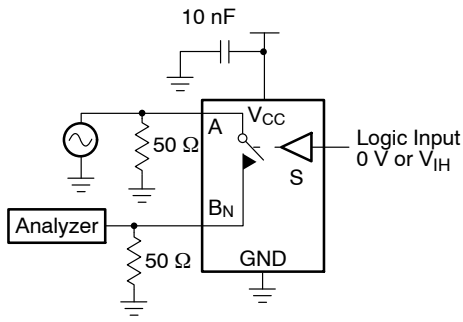

Figure 16. Off Isolation

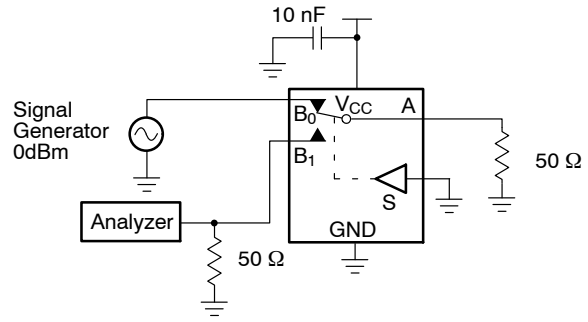

Figure 17. Crosstalk

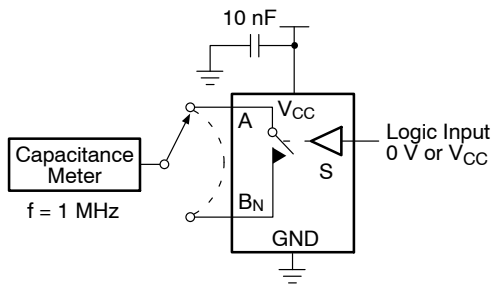

Figure 18. Channel Off Capacitance

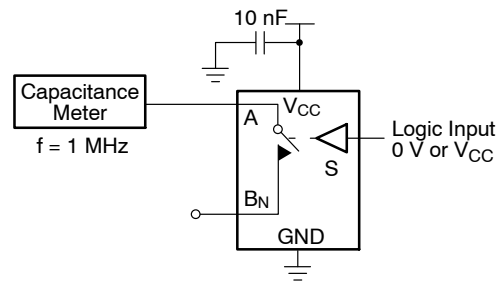

Figure 19. Channel On Capacitance

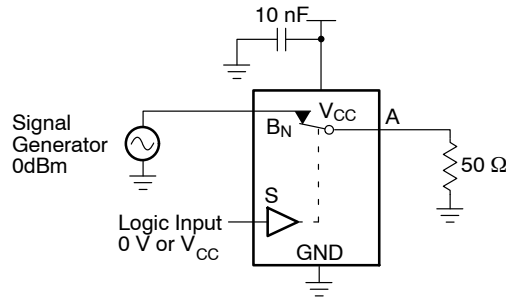

Figure 20. Bandwidth

ORDERING INFORMATION

Part Number	Top Mark	Eco Status	Package Description	Shipping†
NC7SB3157P6X	B7A	RoHS	6-Lead, SC70, EIAJ SC88, 1.25 mm Wide Package	3000 / Tape and Reel
NC7SB3157L6X	BB	RoHS	6-Lead, MicroPak 1.0 mm Wide Package	5000 / Tape and Reel
FSA3157P6X	B7A	RoHS	6-Lead, SC70, EIAJ SC88, 1.25 mm Wide Package	3000 / Tape and Reel
FSA3157L6X	BB	RoHS	6-Lead, MicroPak 1.0 mm Wide Package	5000 / Tape and Reel

†For information on tape and reel specifications, including part orientation and tape sizes, please refer to our Tape and Reel Packaging Specification Brochure, BRD8011/D.

MicroPak is trademark of Semiconductor Components Industries, LLC dba "onsemi" or its affiliates and/or subsidiaries in the United States and/or other countries.

MECHANICAL CASE OUTLINE

PACKAGE DIMENSIONS

ON Semiconductor®



SIP6 1.45X1.0
CASE 127EB
ISSUE O

DATE 31 AUG 2016

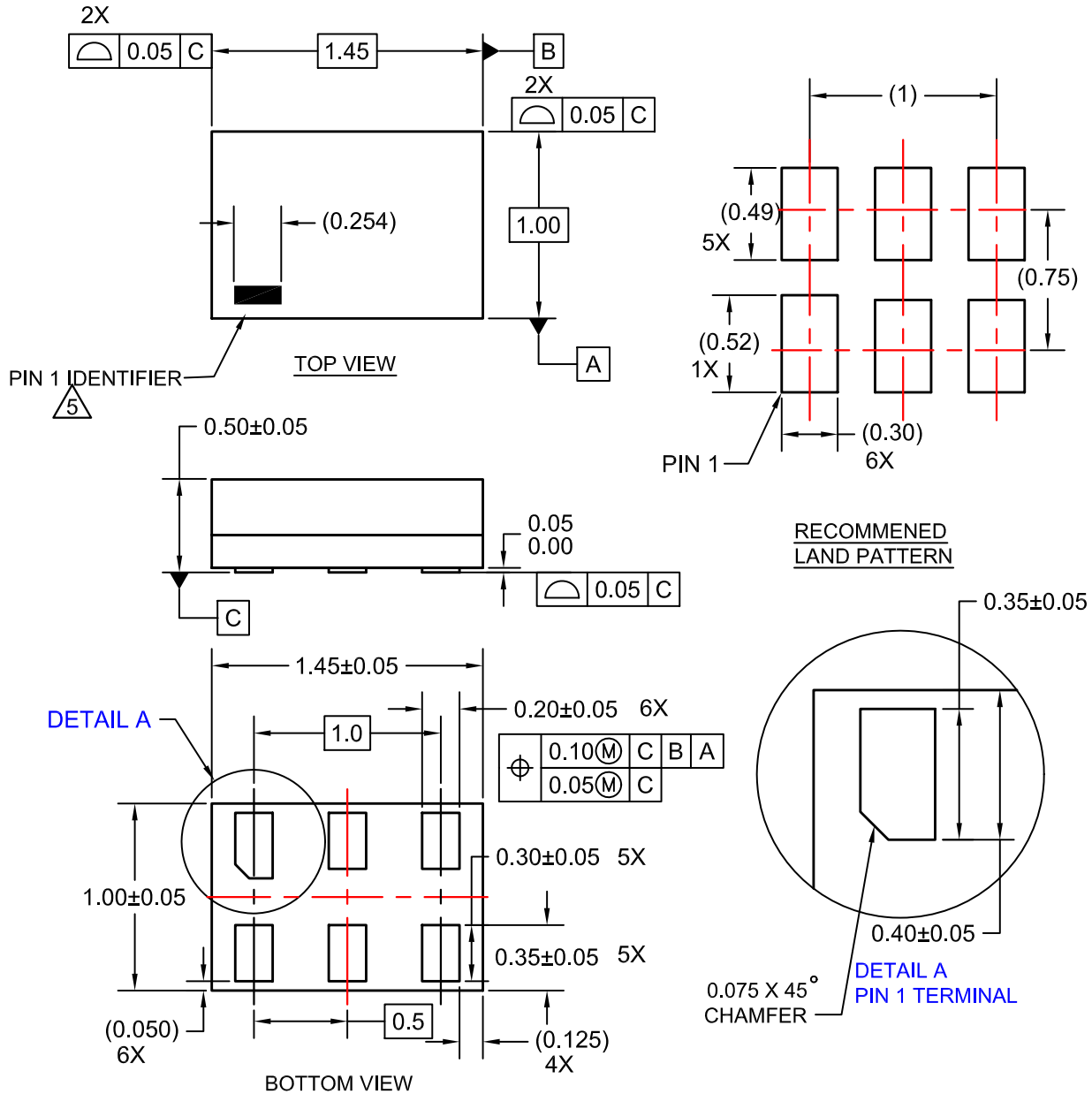

NOTES:

1. CONFORMS TO JEDEC STANDARD MO-252 VARIATION UAAD
2. DIMENSIONS ARE IN MILLIMETERS
3. DRAWING CONFORMS TO ASME Y14.5M-2009
4. PIN ONE IDENTIFIER IS 2X LENGTH OF ANY OTHER LINE IN THE MARK CODE LAYOUT.

DOCUMENT NUMBER:	98AON13590G	Electronic versions are uncontrolled except when accessed directly from the Document Repository. Printed versions are uncontrolled except when stamped "CONTROLLED COPY" in red.
DESCRIPTION:	SIP6 1.45X1.0	PAGE 1 OF 1

ON Semiconductor and are trademarks of Semiconductor Components Industries, LLC dba ON Semiconductor or its subsidiaries in the United States and/or other countries. ON Semiconductor reserves the right to make changes without further notice to any products herein. ON Semiconductor makes no warranty, representation or guarantee regarding the suitability of its products for any particular purpose, nor does ON Semiconductor assume any liability arising out of the application or use of any product or circuit, and specifically disclaims any and all liability, including without limitation special, consequential or incidental damages. ON Semiconductor does not convey any license under its patent rights nor the rights of others.

MECHANICAL CASE OUTLINE

PACKAGE DIMENSIONS

ON Semiconductor®



SC-88 (SC-70 6 Lead), 1.25x2
CASE 419AD-01
ISSUE A

DATE 07 JUL 2010

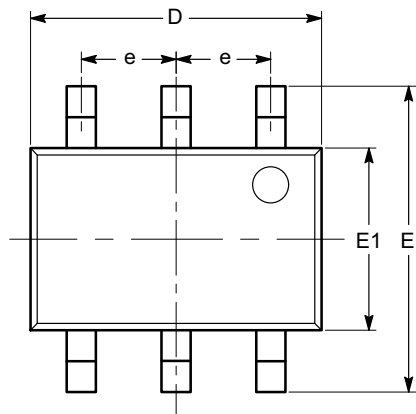

TOP VIEW

SYMBOL	MIN	NOM	MAX
A	0.80		1.10
A1	0.00		0.10
A2	0.80		1.00
b	0.15		0.30
c	0.10		0.18
D	1.80	2.00	2.20
E	1.80	2.10	2.40
E1	1.15	1.25	1.35
e	0.65 BSC		
L	0.26	0.36	0.46
L1	0.42 REF		
L2	0.15 BSC		
θ	0°		8°
θ_1	4°		10°

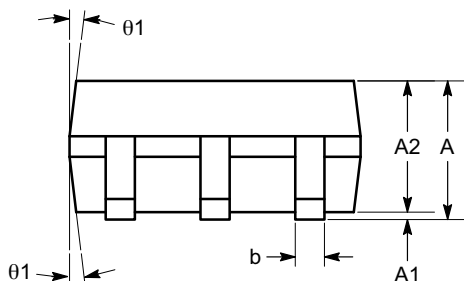

SIDE VIEW

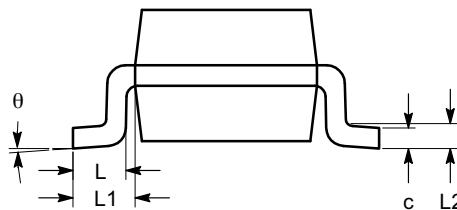

END VIEW

Notes:

- (1) All dimensions are in millimeters. Angles in degrees.
- (2) Complies with JEDEC MO-203.

DOCUMENT NUMBER:	98AON34266E	Electronic versions are uncontrolled except when accessed directly from the Document Repository. Printed versions are uncontrolled except when stamped "CONTROLLED COPY" in red.
DESCRIPTION:	SC-88 (SC-70 6 LEAD), 1.25X2	PAGE 1 OF 1

ON Semiconductor and are trademarks of Semiconductor Components Industries, LLC dba ON Semiconductor or its subsidiaries in the United States and/or other countries. ON Semiconductor reserves the right to make changes without further notice to any products herein. ON Semiconductor makes no warranty, representation or guarantee regarding the suitability of its products for any particular purpose, nor does ON Semiconductor assume any liability arising out of the application or use of any product or circuit, and specifically disclaims any and all liability, including without limitation special, consequential or incidental damages. ON Semiconductor does not convey any license under its patent rights nor the rights of others.

onsemi, **Onsemi**, and other names, marks, and brands are registered and/or common law trademarks of Semiconductor Components Industries, LLC dba "**onsemi**" or its affiliates and/or subsidiaries in the United States and/or other countries. **onsemi** owns the rights to a number of patents, trademarks, copyrights, trade secrets, and other intellectual property. A listing of **onsemi**'s product/patent coverage may be accessed at www.onsemi.com/site/pdf/Patent-Marking.pdf. **onsemi** reserves the right to make changes at any time to any products or information herein, without notice. The information herein is provided "as-is" and **onsemi** makes no warranty, representation or guarantee regarding the accuracy of the information, product features, availability, functionality, or suitability of its products for any particular purpose, nor does **onsemi** assume any liability arising out of the application or use of any product or circuit, and specifically disclaims any and all liability, including without limitation special, consequential or incidental damages. Buyer is responsible for its products and applications using **onsemi** products, including compliance with all laws, regulations and safety requirements or standards, regardless of any support or applications information provided by **onsemi**. "Typical" parameters which may be provided in **onsemi** data sheets and/or specifications can and do vary in different applications and actual performance may vary over time. All operating parameters, including "Typicals" must be validated for each customer application by customer's technical experts. **onsemi** does not convey any license under any of its intellectual property rights nor the rights of others. **onsemi** products are not designed, intended, or authorized for use as a critical component in life support systems or any FDA Class 3 medical devices or medical devices with a same or similar classification in a foreign jurisdiction or any devices intended for implantation in the human body. Should Buyer purchase or use **onsemi** products for any such unintended or unauthorized application, Buyer shall indemnify and hold **onsemi** and its officers, employees, subsidiaries, affiliates, and distributors harmless against all claims, costs, damages, and expenses, and reasonable attorney fees arising out of, directly or indirectly, any claim of personal injury or death associated with such unintended or unauthorized use, even if such claim alleges that **onsemi** was negligent regarding the design or manufacture of the part. **onsemi** is an Equal Opportunity/Affirmative Action Employer. This literature is subject to all applicable copyright laws and is not for resale in any manner.

PUBLICATION ORDERING INFORMATION

LITERATURE FULFILLMENT:

Email Requests to: orderlit@onsemi.com

onsemi Website: www.onsemi.com

TECHNICAL SUPPORT

North American Technical Support:

Voice Mail: 1 800-282-9855 Toll Free USA/Canada

Phone: 011 421 33 790 2910

Europe, Middle East and Africa Technical Support:

Phone: 00421 33 790 2910

For additional information, please contact your local Sales Representative