

CUSTOMER : _____.

DATE : 2015.10.19 .

REV : Rev 1.0 .

PRODUCT FAMILY DATA SHEET

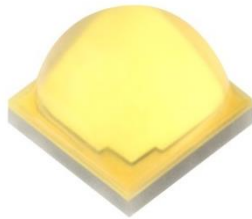

High Power LED series
3535 Ceramic

MODEL NAME : LEMWE333 *** *****



APPROVAL	REMARK	APPENDIX

DESIGNED	CHECKED	APPROVED

TABLE OF CONTENTS

1. Features	-----	2
2. Applications	-----	2
3. Outline Dimensions	-----	2
4. Absolute Maximum Ratings	-----	3
5. Electro-Optical Characteristics	-----	3~4
6. Flux Characteristics and Order Code	-----	5
7. Chromaticity Bins	-----	6~8
8. Typical Characteristic Curves	-----	9~14
9. Reliability Test Items and Conditions	-----	15
10. Packing and Labeling of Products	-----	16~19
11. Cautions on Use	-----	20~23
12. Disclaimers	-----	23
13. Package Nomenclature	-----	24

1. Features

- Lighting Color : White
- Lead Frame Type LED Package : 3.45 x 3.45 x 2.68 (L x W x H) [Unit : mm]
- Viewing Angle : 125°
- Chip Material : InGaN
- Soldering Methods : Reflow soldering
- ESD Withstand Voltage : Up to 8kV According to JS-001

2. Applications

- Interior and Exterior Illumination

3. Outline Dimensions

(Unit : mm)

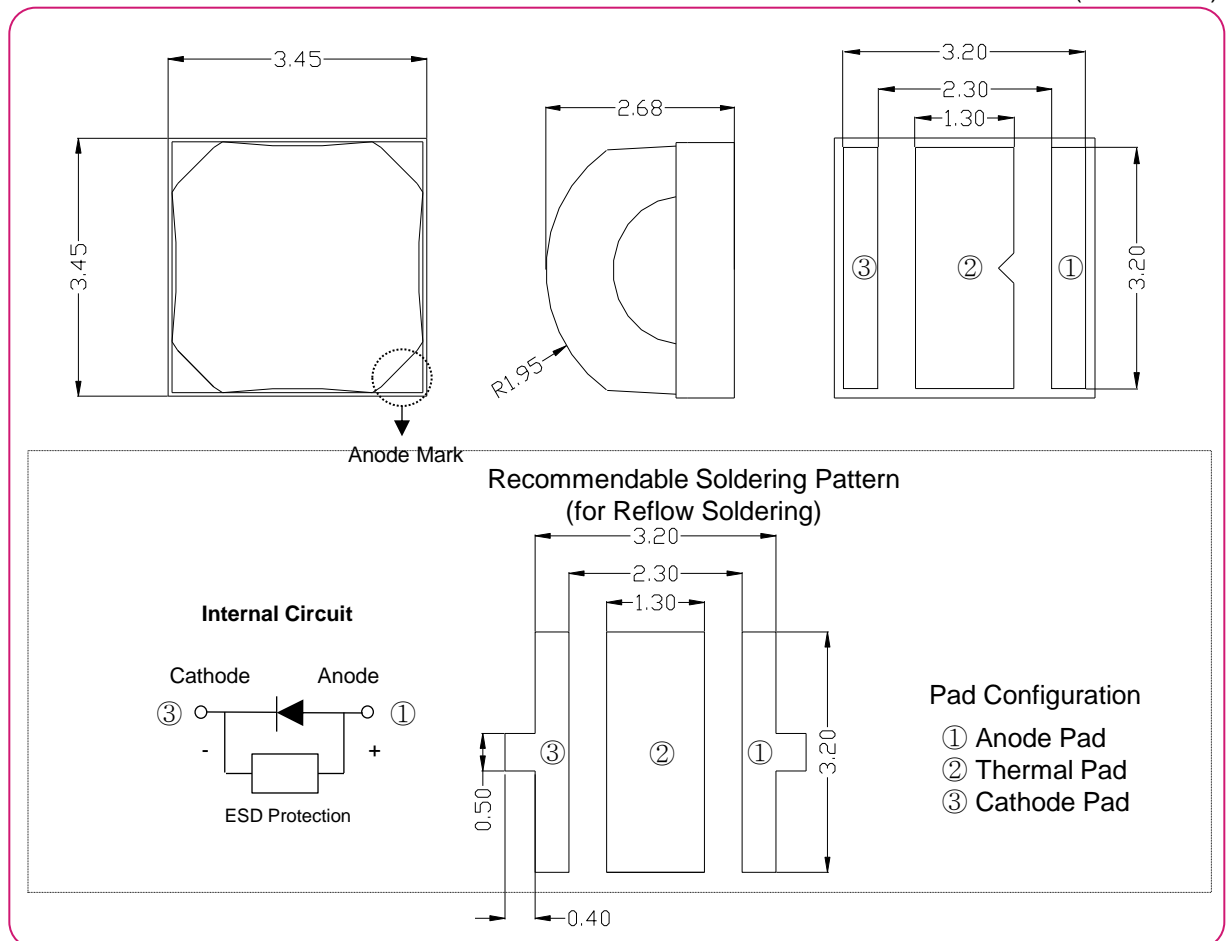

Tolerances unless otherwise mentioned are ± 0.25 mm

4. Absolute Maximum Ratings

(Ta=25℃)

Item	Symbol	Rating	Unit
Forward Current	If	3000	mA
Operating Temperature	Topr	-40 ~ +85	℃
Storage Temperature	Tstg	-40 ~ +100	℃
Junction Temperature	Tj	150	℃
Soldering Temperature	JEDEC-J-STD-020		
ESD Classification	Class 3B (JS-001)		

- ※ Operating the LED beyond the listed maximum ratings may affect device reliability and cause permanent damage. These or any other conditions beyond those indicated under recommended operating conditions are not implied. The exposure to the absolute maximum rated conditions may affect device reliability.
- ※ The LEDs are not designed to be driven in reverse bias.

5. Electro - Optical Characteristics

(Tj=85℃ , If=1050mA)

Item	Symbol	White Color	Min.	Typ.	Max.	Unit
Luminous Flux	Φ_v	Cool	-	450	-	lm
		Neutral	-	439	-	lm
		Warm	-	380	-	lm
Forward Voltage	Vf	All	2.65	2.80	3.15	V
Color Coordinate	Cx / Cy	-	Refer to 'Chromaticity Bins'			-
Viewing Angle	2 θ 1/2	All	-	125	-	deg
Color Rendering Index (CRI)	Ra	Cool	70/ 80	-	-	-
		Neutral	70	-	-	-
		Warm	80	-	-	-
Thermal Resistance, Junction to Solder Point	Rth j-s	All	-	2.5	-	℃/W
Typical Temperature Coefficient of Forward Voltage ^{*1)}	$\Delta V_f / \Delta T_j$	All	-1.0	-	-4.0	mV/℃

*1) Measured at Ta between 25℃ and 150℃.

- ※ These values are measured by the LG Innotek optical spectrum analyzer within the following tolerances. Luminous Flux (Φ_v) : $\pm 7\%$, Forward Voltage (Vf) : $\pm 0.1V$, Color Value : ± 0.005 , CRI Value : ± 2 ,
- ※ Although all LEDs are tested by LG Innotek equipment, some values may vary slightly depending on the conditions of the test equipment.

5. Electro - Optical Characteristics

(T_j=85°C)

CCT	CRI	I _f (mA)	V _f (V)	Power (W)	Φ _v (lm)	lm/W
6500K (F)	70	350	2.64	0.92	170	184
		700	2.73	1.91	316	165
		1050	2.80	2.94	450	153
		1500	2.89	4.33	607	140
		2000	2.97	5.94	767	129
		3000	3.12	9.36	1045	112
5000K (H)	80	350	2.64	0.92	151	163
		700	2.73	1.91	281	147
		1050	2.80	2.94	400	136
		1500	2.89	4.33	539	124
		2000	2.97	5.94	681	115
		3000	3.12	9.36	929	99
4000K (J)	70	350	2.64	0.92	165	179
		700	2.73	1.91	308	161
		1050	2.80	2.94	439	149
		1500	2.89	4.33	592	137
		2000	2.97	5.94	748	126
		3000	3.12	9.36	1019	109
3000K (L)	80	350	2.64	0.92	143	155
		700	2.73	1.91	266	140
		1050	2.80	2.94	380	129
		1500	2.89	4.33	512	118
		2000	2.97	5.94	647	109
		3000	3.12	9.36	881	94

※ All the values in this table are for representative references only.

6. Flux Characteristics and Order Code

(T_j = 85 °C / T_a = 25 °C)

Color	CCT (K)	CRI (85 °C)	V _f	Luminous Flux [lm]						Order Code	
			1050mA 85 °C	Bin Code	700mA 85 °C	1050mA 85 °C	1050mA 25 °C	2000mA 85 °C	3000mA 85 °C		
	Typ	Min	Typ		Min	Min	Min	Min	Min		
Cool	6500 K	70<	2.80 V	30	281	400	430	682	929	LEMWE33370F*****	
				31	295	420	452	716	975		
				32	309	440	473	750	1022		
	5700 K	70<		30	281	400	430	682	929	LEMWE33370G*****	
				31	295	420	452	716	975		
				32	309	440	473	750	1022		
				33	323	460	495	784	1068		
	5000 K	70<		31	295	420	452	716	975	LEMWE33370H*****	
				32	309	440	473	750	1022		
				33	323	460	495	784	1068		
				34	337	480	516	818	1114		
	5300 K	80<		29	267	380	409	648	882	LEMWE33380S*****	
				30	281	400	430	682	929		
				31	295	420	452	716	975		
				32	309	440	473	750	1022		
	4500 K	70<		30	281	400	430	682	929	LEMWE33370I*****	
				31	295	420	452	716	975		
				32	309	440	473	750	1022		
				33	323	460	495	784	1068		
	Neutral	4000 K		70<	30	281	400	430	682	929	LEMWE33370J*****
					31	295	420	452	716	975	
					32	309	440	473	750	1022	
					33	323	460	495	784	1068	
	Warm	3000 K		80<	28	253	360	387	613	836	LEMWE33380L*****
29			267		380	409	648	882			
30			281		400	430	682	929			

7. Chromaticity Bins

LG Innotek complies with the ANSI C78.377A standard for its chromaticity bin structure. For ANSI quadrangle for the CCT range of 4500K to 6500K, LG Innotek provides 4 micro bins.

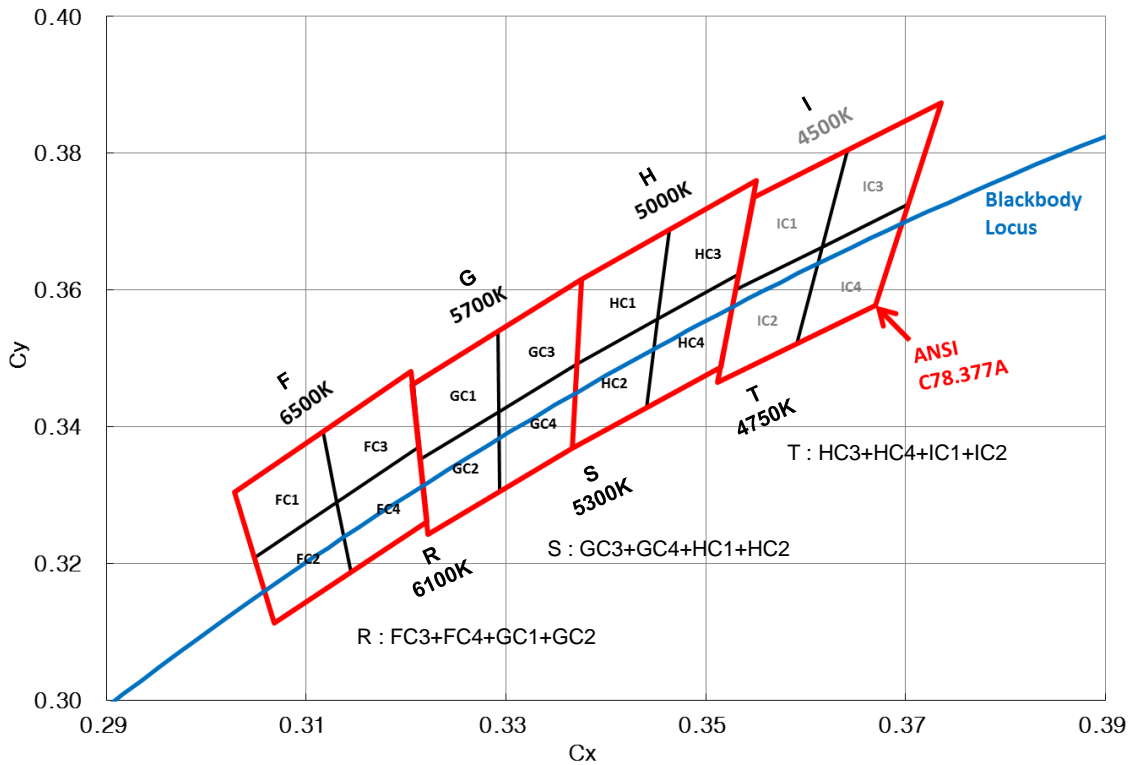

Bin	CIE X	CIE Y	Bin	CIE X	CIE Y	Bin	CIE X	CIE Y	Bin	CIE X	CIE Y
FC1	0.3028	0.3304	GC1	0.3207	0.3462	HC1	0.3376	0.3616	IC1	0.3548	0.3736
	0.3117	0.3393		0.3292	0.3539		0.3464	0.3688		0.3642	0.3805
	0.3131	0.3290		0.3293	0.3423		0.3452	0.3558		0.3617	0.3663
	0.3048	0.3209		0.3215	0.3353		0.3371	0.3493		0.3530	0.3601
FC2	0.3048	0.3209	GC2	0.3215	0.3353	HC2	0.3371	0.3493	IC2	0.3530	0.3601
	0.3131	0.3290		0.3293	0.3423		0.3452	0.3558		0.3617	0.3663
	0.3145	0.3187		0.3294	0.3306		0.3441	0.3428		0.3591	0.3522
	0.3068	0.3113		0.3222	0.3243		0.3366	0.3369		0.3512	0.3465
FC3	0.3117	0.3393	GC3	0.3292	0.3539	HC3	0.3464	0.3688	IC3	0.3642	0.3805
	0.3205	0.3481		0.3376	0.3616		0.3551	0.3760		0.3736	0.3874
	0.3213	0.3371		0.3371	0.3493		0.3533	0.3624		0.3703	0.3726
	0.3131	0.3290		0.3293	0.3423		0.3452	0.3558		0.3617	0.3663
FC4	0.3131	0.3290	GC4	0.3293	0.3423	HC4	0.3452	0.3558	IC4	0.3617	0.3663
	0.3213	0.3371		0.3371	0.3493		0.3533	0.3624		0.3703	0.3726
	0.3221	0.3261		0.3366	0.3369		0.3515	0.3487		0.3670	0.3578
	0.3145	0.3187		0.3294	0.3306		0.3441	0.3428		0.3591	0.3522

7. Chromaticity Bins (Continued)

LG Innotek complies with the ANSI C78.377A standard for its chromaticity bin structure. For each ANSI quadrangle for the CCT range of 2700K to 4000K, LG Innotek provides 16 micro bins.

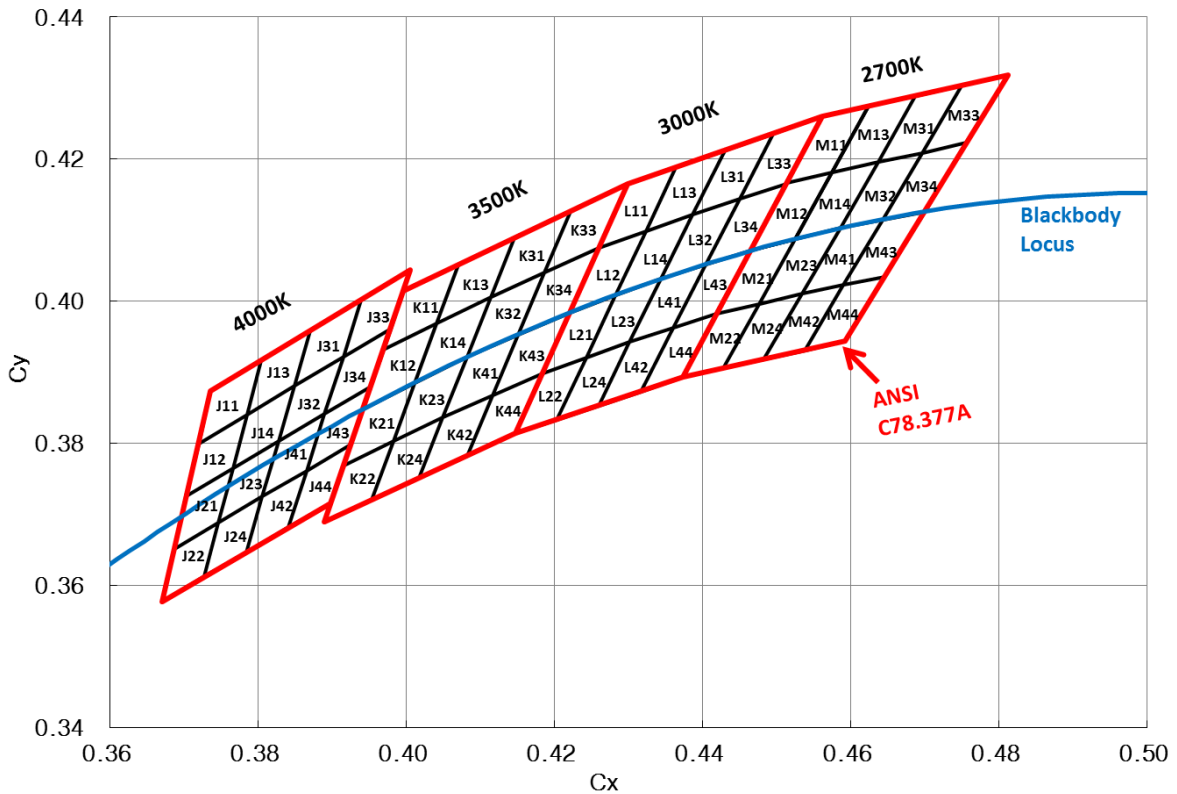

Bin	CIE X	CIE Y	Bin	CIE X	CIE Y	Bin	CIE X	CIE Y	Bin	CIE X	CIE Y
JB1	0.3714	0.3775	K11	0.3996	0.4015	L11	0.4299	0.4165	M11	0.4562	0.4260
	0.3736	0.3874		0.4071	0.4052		0.4364	0.4189		0.4625	0.4275
	0.3826	0.3931		0.4041	0.3969		0.4323	0.4098		0.4575	0.4181
	0.3799	0.3828		0.3969	0.3932		0.4260	0.4075		0.4513	0.4166
JB2	0.3692	0.3677	K12	0.3969	0.3932	L12	0.4260	0.4075	M12	0.4513	0.4166
	0.3714	0.3775		0.4041	0.3969		0.4323	0.4098		0.4575	0.4181
	0.3799	0.3828		0.4012	0.3885		0.4282	0.4008		0.4525	0.4087
	0.3773	0.3726		0.3941	0.3848		0.4221	0.3984		0.4465	0.4071
JB3	0.3670	0.3578	K13	0.4071	0.4052	L13	0.4364	0.4189	M13	0.4625	0.4275
	0.3692	0.3677		0.4146	0.4089		0.4430	0.4212		0.4687	0.4289
	0.3773	0.3726		0.4114	0.4005		0.4387	0.4122		0.4637	0.4196
	0.3746	0.3624		0.4041	0.3969		0.4323	0.4098		0.4575	0.4181
JB4	0.3799	0.3828	K14	0.4041	0.3969	L14	0.4323	0.4098	M14	0.4575	0.4181
	0.3826	0.3931		0.4114	0.4005		0.4387	0.4122		0.4637	0.4196
	0.3916	0.3987		0.4082	0.3922		0.4344	0.4032		0.4586	0.4103
	0.3885	0.3882		0.4012	0.3885		0.4282	0.4008		0.4525	0.4087

7. Chromaticity Bins (Continued)

Bin	CIE X	CIE Y	Bin	CIE X	CIE Y	Bin	CIE X	CIE Y	Bin	CIE X	CIE Y
J21	0.3703	0.3726	K21	0.3941	0.3848	L21	0.4221	0.3984	M21	0.4465	0.4071
	0.3766	0.3765		0.4012	0.3885		0.4282	0.4008		0.4525	0.4087
	0.3746	0.3689		0.3982	0.3803		0.4243	0.3921		0.4477	0.3996
	0.3687	0.3652		0.3915	0.3769		0.4184	0.3899		0.4419	0.3982
J22	0.3687	0.3652	K22	0.3915	0.3769	L22	0.4184	0.3899	M22	0.4419	0.3982
	0.3746	0.3689		0.3982	0.3803		0.4243	0.3921		0.4477	0.3996
	0.3727	0.3613		0.3950	0.3721		0.4203	0.3834		0.4428	0.3906
	0.3670	0.3578		0.3889	0.3690		0.4147	0.3814		0.4373	0.3893
J23	0.3766	0.3765	K23	0.4012	0.3885	L23	0.4282	0.4008	M23	0.4525	0.4087
	0.3828	0.3803		0.4082	0.3922		0.4344	0.4032		0.4586	0.4103
	0.3806	0.3725		0.4050	0.3837		0.4302	0.3943		0.4535	0.4011
	0.3746	0.3689		0.3982	0.3803		0.4243	0.3921		0.4477	0.3996
J24	0.3746	0.3689	K24	0.3982	0.3803	L24	0.4243	0.3921	M24	0.4477	0.3996
	0.3806	0.3725		0.4050	0.3837		0.4302	0.3943		0.4535	0.4011
	0.3784	0.3647		0.4017	0.3752		0.4260	0.3853		0.4483	0.3918
	0.3727	0.3613		0.3953	0.3721		0.4203	0.3834		0.4428	0.3906
J31	0.3871	0.3959	K31	0.4146	0.4089	L31	0.4430	0.4212	M31	0.4687	0.4289
	0.3939	0.4002		0.4223	0.4127		0.4496	0.4236		0.4750	0.4304
	0.3915	0.3922		0.4187	0.4040		0.4450	0.4144		0.4697	0.4209
	0.3849	0.3881		0.4114	0.4005		0.4387	0.4122		0.4637	0.4196
J32	0.3849	0.3881	K32	0.4114	0.4005	L32	0.4387	0.4122	M32	0.4637	0.4196
	0.3915	0.3922		0.4187	0.4040		0.4450	0.4144		0.4697	0.4209
	0.3890	0.3842		0.4151	0.3953		0.4404	0.4052		0.4643	0.4115
	0.3828	0.3803		0.4082	0.3922		0.4344	0.4032		0.4586	0.4103
J33	0.3939	0.4002	K33	0.4223	0.4127	L33	0.4496	0.4236	M33	0.4750	0.4304
	0.4006	0.4044		0.4299	0.4165		0.4562	0.4260		0.4813	0.4319
	0.3979	0.3962		0.4260	0.4075		0.4513	0.4166		0.4756	0.4223
	0.3915	0.3922		0.4187	0.4040		0.4450	0.4144		0.4697	0.4209
J34	0.3915	0.3922	K34	0.4187	0.4040	L34	0.4450	0.4144	M34	0.4697	0.4209
	0.3979	0.3962		0.4260	0.4075		0.4513	0.4166		0.4756	0.4223
	0.3952	0.3880		0.4221	0.3984		0.4465	0.4071		0.4700	0.4126
	0.3890	0.3842		0.4151	0.3953		0.4404	0.4052		0.4643	0.4115
J41	0.3828	0.3803	K41	0.4082	0.3922	L41	0.4344	0.4032	M41	0.4586	0.4103
	0.3890	0.3842		0.4151	0.3953		0.4404	0.4052		0.4643	0.4115
	0.3866	0.3762		0.4117	0.3868		0.4360	0.3962		0.4590	0.4023
	0.3806	0.3725		0.4050	0.3837		0.4302	0.3943		0.4535	0.4011
J42	0.3806	0.3725	K42	0.4050	0.3837	L42	0.4302	0.3943	M42	0.4535	0.4011
	0.3866	0.3762		0.4117	0.3868		0.4360	0.3962		0.4590	0.4023
	0.3841	0.3682		0.4082	0.3783		0.4316	0.3873		0.4538	0.3931
	0.3784	0.3647		0.4017	0.3752		0.4260	0.3853		0.4483	0.3918
J43	0.3890	0.3842	K43	0.4151	0.3953	L43	0.4404	0.4052	M43	0.4643	0.4115
	0.3952	0.3880		0.4221	0.3984		0.4465	0.4071		0.4700	0.4126
	0.3925	0.3798		0.4184	0.3899		0.4419	0.3982		0.4646	0.4035
	0.3866	0.3762		0.4117	0.3868		0.4360	0.3962		0.4590	0.4023
J44	0.3866	0.3762	K44	0.4117	0.3868	L44	0.4360	0.3962	M44	0.4590	0.4023
	0.3925	0.3798		0.4184	0.3899		0.4419	0.3982		0.4646	0.4035
	0.3898	0.3716		0.4147	0.3814		0.4373	0.3893		0.4593	0.3944
	0.3841	0.3682		0.4082	0.3783		0.4316	0.3873		0.4538	0.3931

8. Typical Characteristic Curves

- Forward Current vs. Forward Voltage

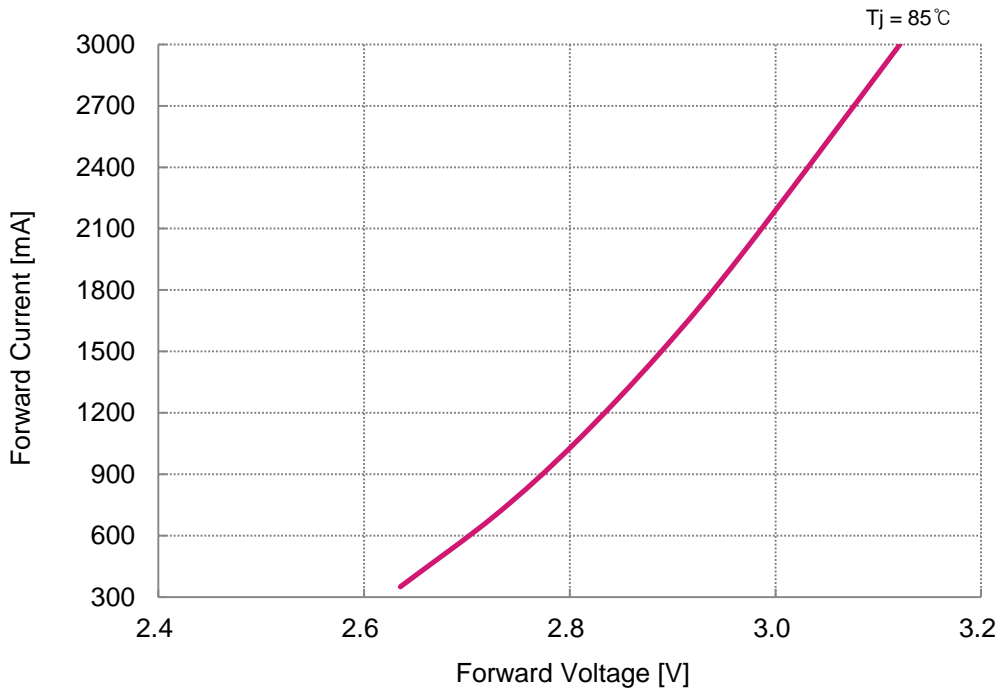

- Relative Luminous Flux vs. Forward Current

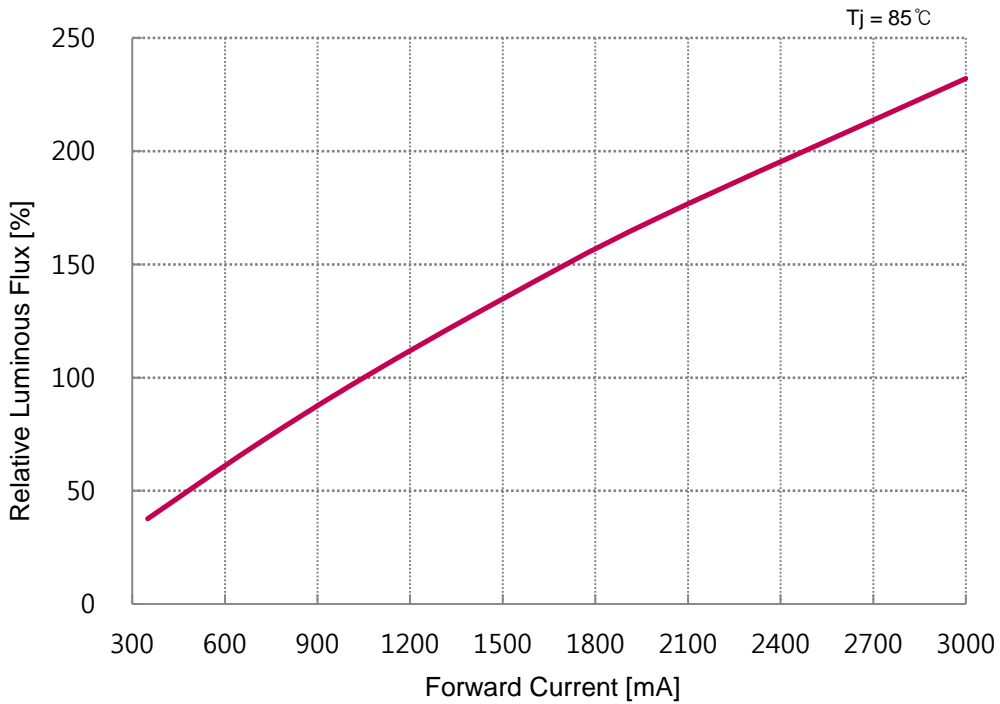

8. Typical Characteristic Curves

▪ Spectrum

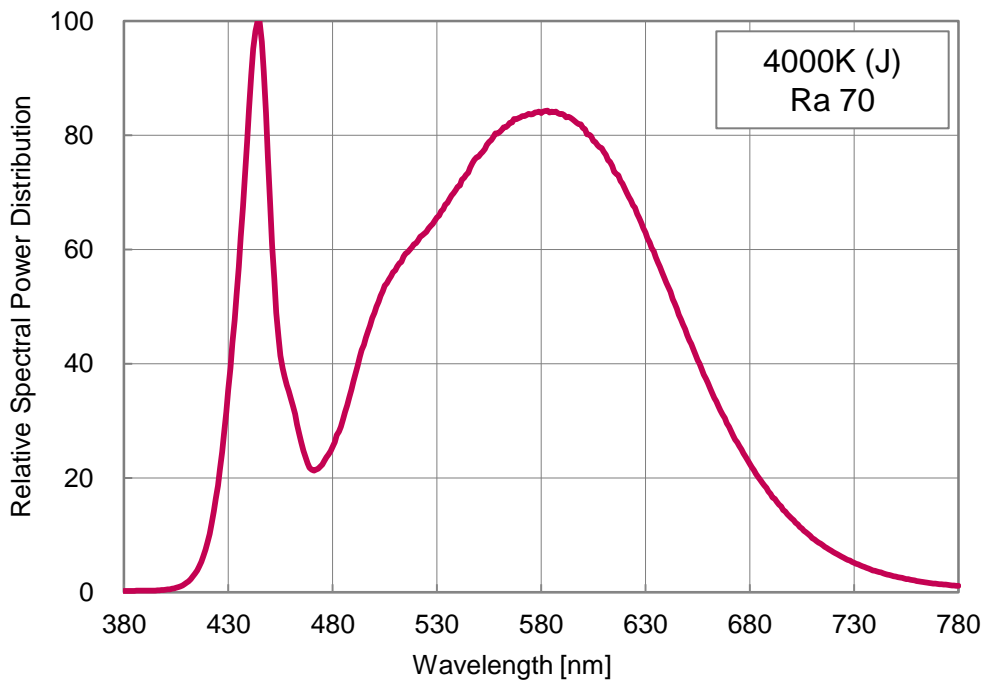
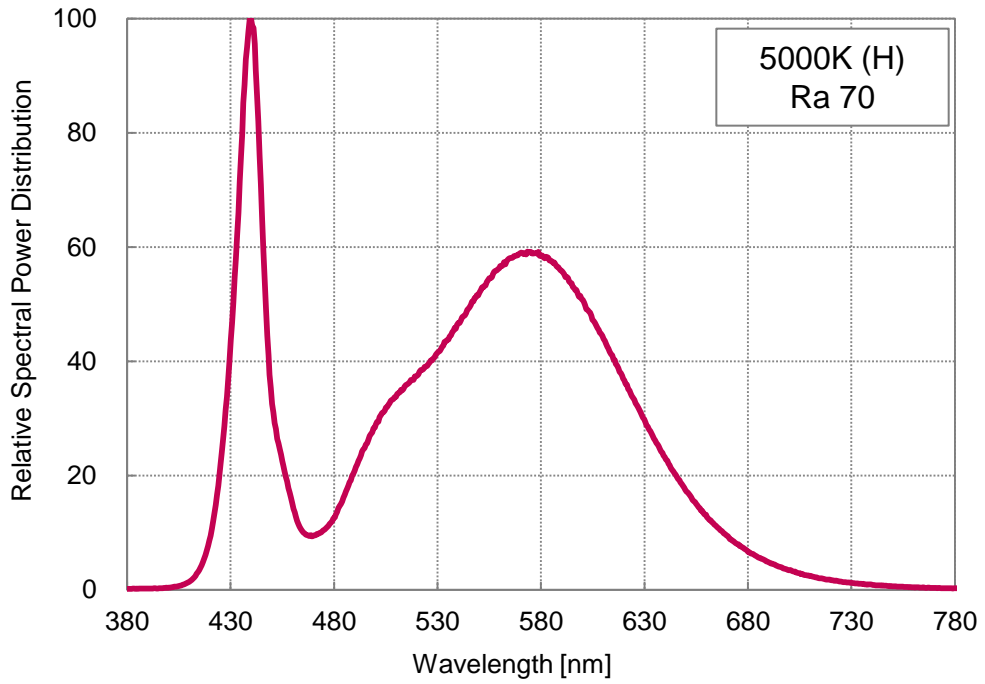

8. Typical Characteristic Curves

- Spectrum

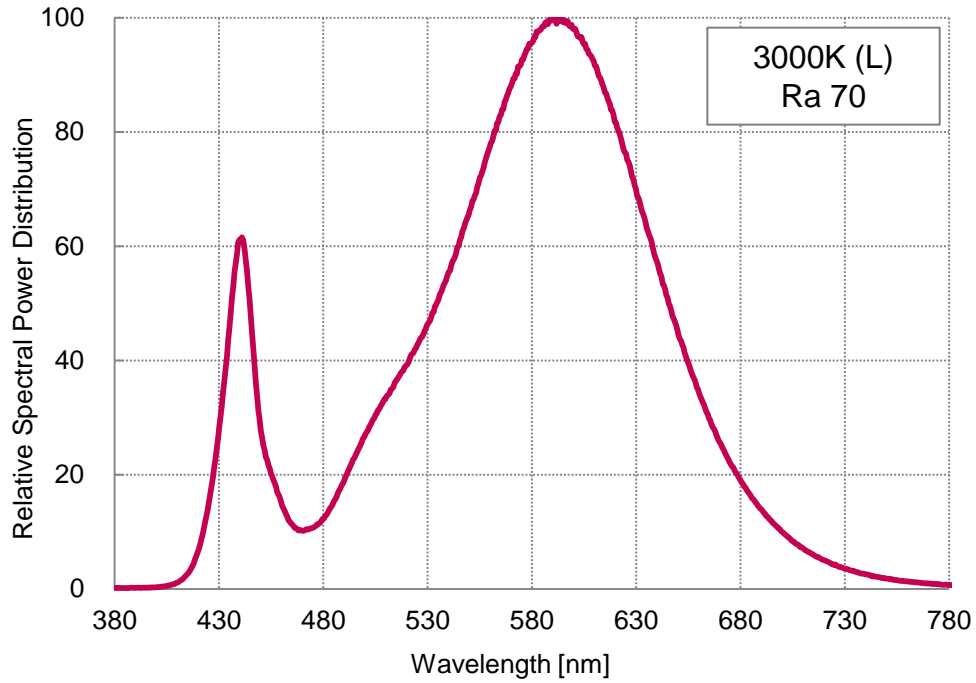

8. Typical Characteristic Curves

- Radiation Characteristics

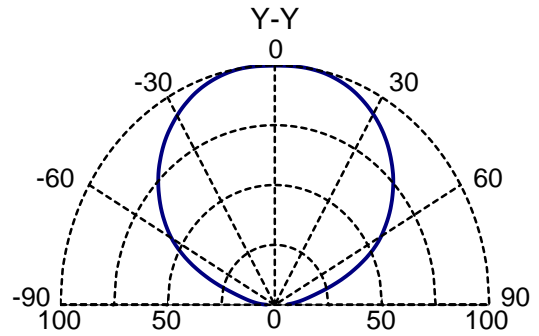
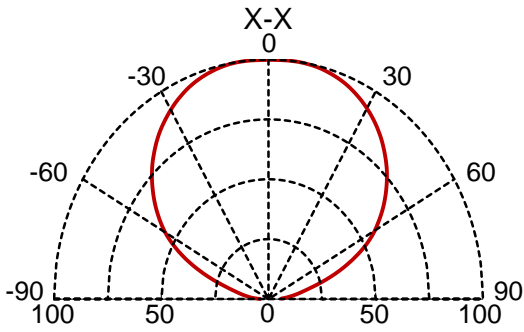

- Chromaticity Coordinate vs. Forward Current

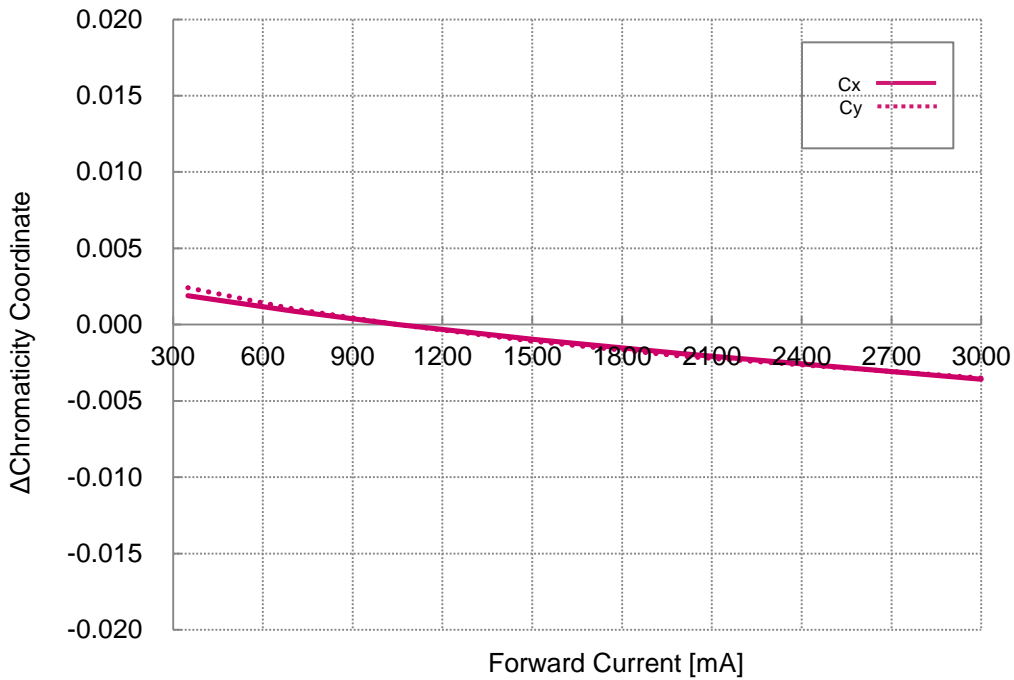

8. Typical Characteristic Curves

▪ Luminous Flux vs. Temperature

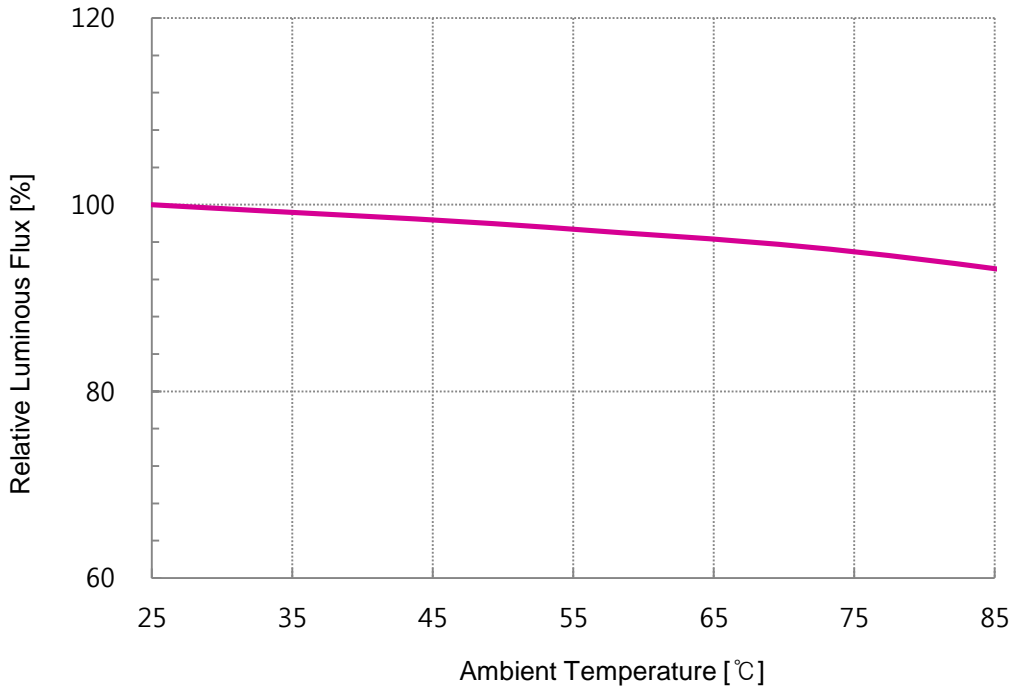

▪ Chromaticity Coordinate vs. Temperature

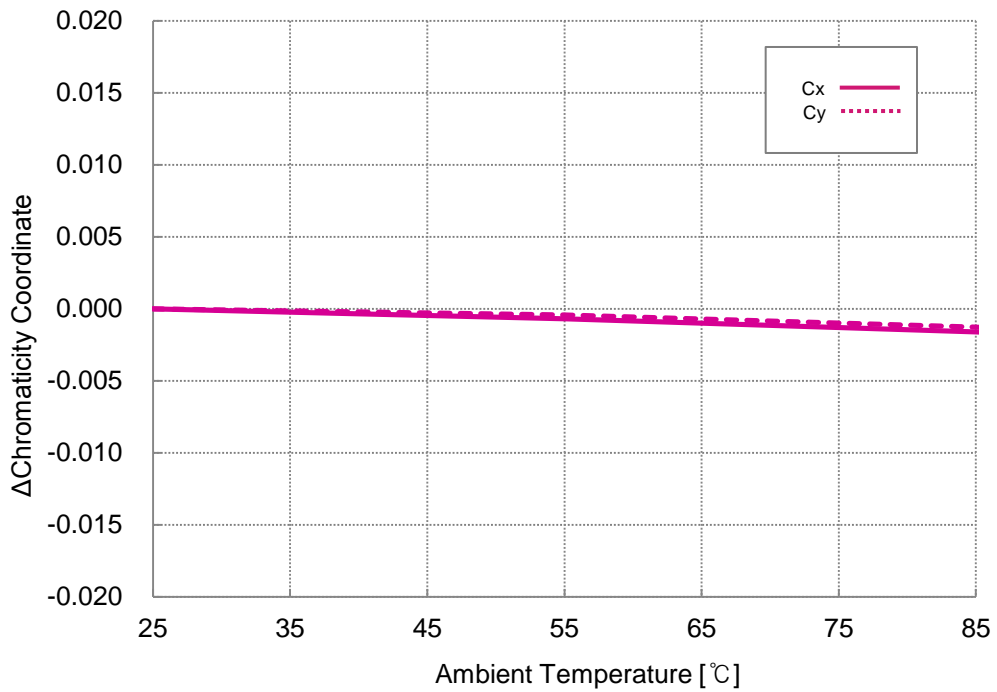

8. Typical Characteristic Curves

▪ Forward Voltage vs. Temperature

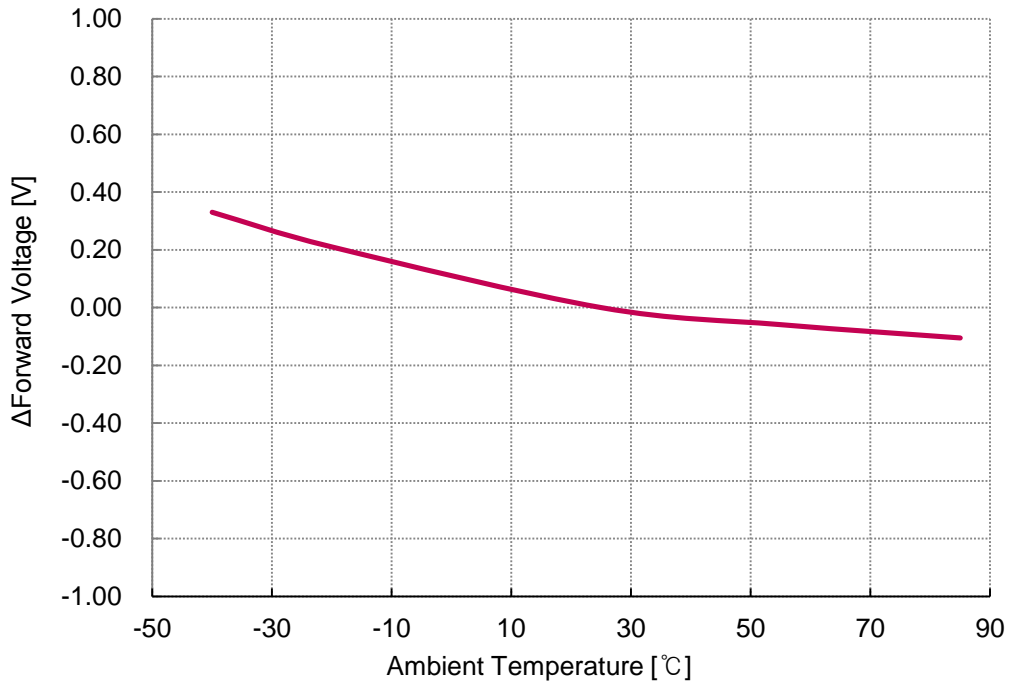

▪ Derating Curve

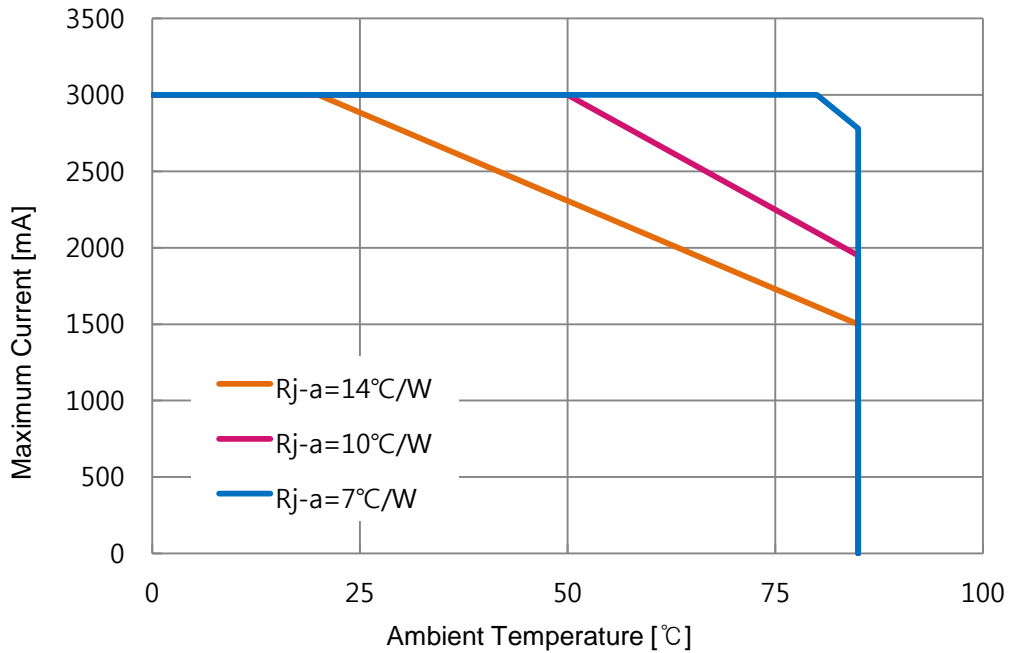

※ The ambient temperature values for each graph are obtained with LG Innotek equipment.

9. Reliability Test Items and Conditions

9-1. Failure Criteria

Items	Symbol	Test Conditions	Criteria	
			Min.	Max.
Forward Voltage	V _f	I _f = 1,050mA	-	Initial Value × 1.1
Luminous Flux	Φ _v	I _f = 1,050mA	Initial Value × 0.7	-

9-2. Reliability Tests

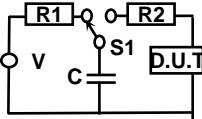
No	Items	Test Conditions	Test Hours /Cycles	Sample Size	Ac/Re
1	Room Temperature Operating Life (RTOL)	T _a = 25 °C, I _f = 3,000mA	1,000 Hours	11 pcs	0/1
2	Wet High Temperature Operating Life (WHTOL)	T _a = 85 °C, RH = 85% I _f = 1,500mA	500 Hours	11 pcs	0/1
3	High Temperature Operating Life (HTOL)	T _a = 85 °C, I _f = 2,000mA	1,000 Hours	11 pcs	0/1
4	Low Temperature Operating Life (LTOL)	T _a = -40 °C, I _f = 1,500mA	1,000 Hours	11 pcs	0/1
5	High Temperature Storage Life (HTSL)	T _a = 100 °C	1,000 Hours	11 pcs	0/1
6	Low Temperature Storage Life (LTSL)	T _a = -40 °C	1,000 Hours	11 pcs	0/1
7	Wet High Temperature Storage Life (WHTSL)	T _a = 85 °C, RH = 85%	1,000 Hours	11 pcs	0/1
8	Temperature Cycle (TC)	-40 °C (30min) ~ 100 °C (30min)	100 Cycles	11 pcs	0/1
9	Moisture Sensitivity Level (MSL)	T _{sld} = 260 °C (Pre treatment 60 °C, 60% 168 hours)	3 Times	11 pcs	0/1
10	Electrostatic Discharge Test Voltage 8kV (HBM)	 R1 : 10MΩ, R2 : 1.5kΩ, C : 100pF	3 Times	11 pcs	0/1
11	Vibration	100~2000~100Hz Sweep 4min. 200m/s ² , 3 directions, 4Cycles	48 Minutes	20 pcs	0/1

※ All samples are tested using LG Innotek Standard Metal PCB (25x25x1.6 mm³(L×W×H)) except MSL test .

※ All samples must pass each test item and all test items must be satisfied.

10. Packing and Labeling of Products

10-1. Taping Outline Dimensions

Reel

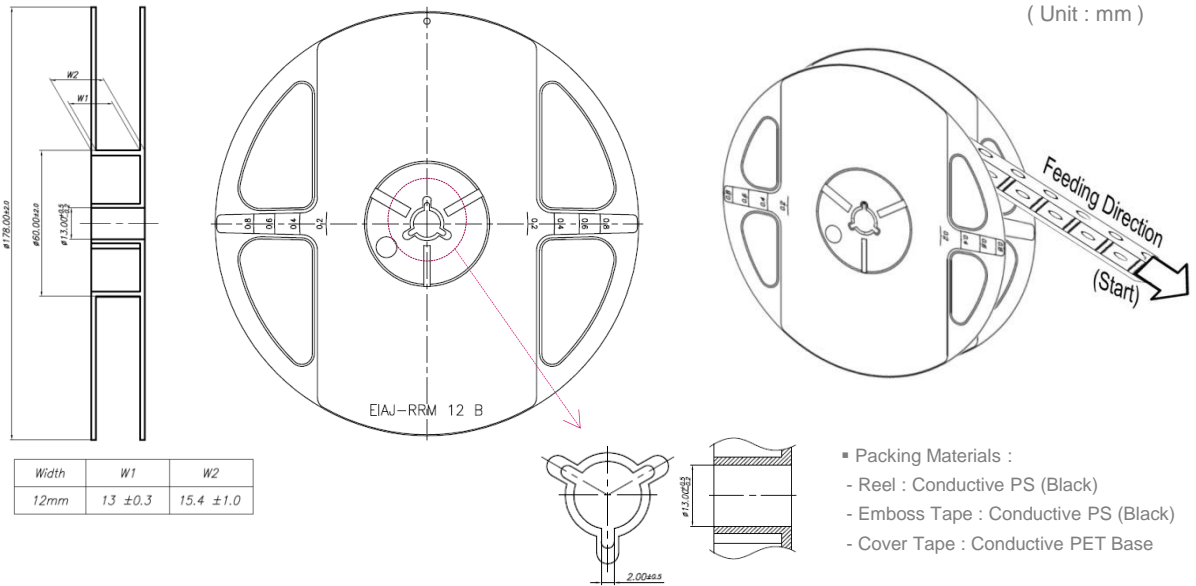

Tape

Polarity Direction in Pocket

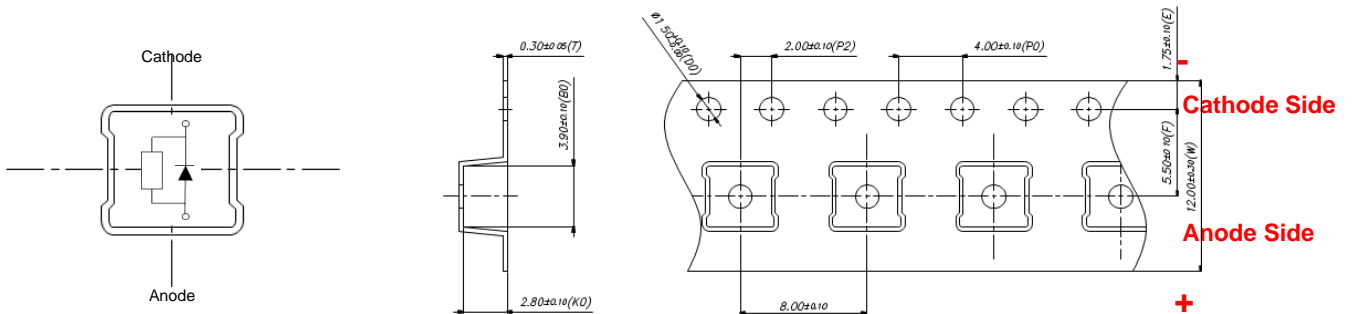

Taping Arrangement



10. Packing and Labeling of Products

10-2. Label Structure

※. Label A

Specifying 'Lot ID', 'Model Name', 'MES ID', 'RANK', 'Q'ty', 'Run No'.

<Example>

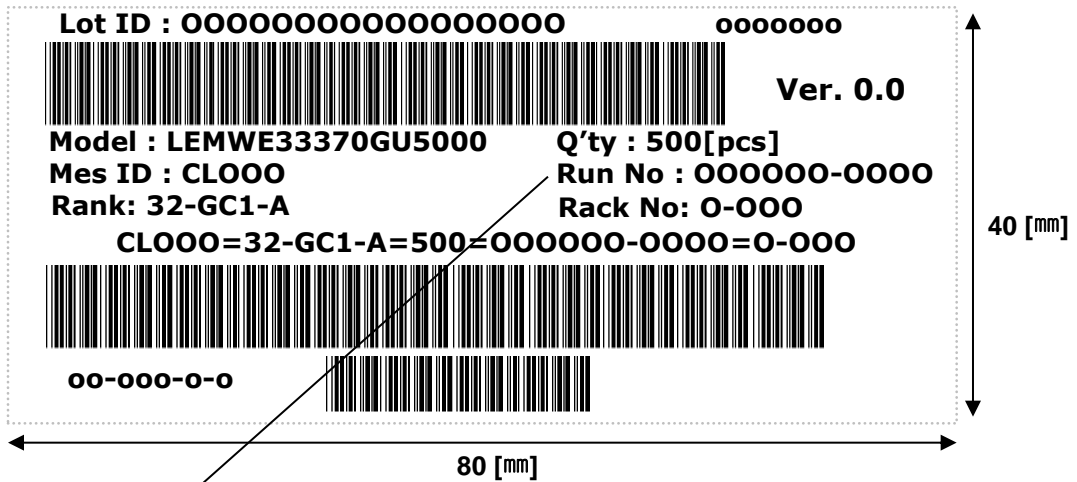

▪ Run No. indication

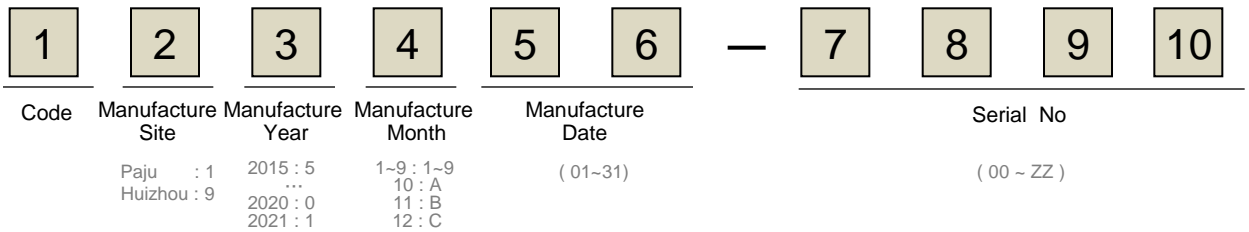

10. Packing and Labeling of Products

10-2. Label Structure

※. Label C

Specifying 'Customer', 'Date', 'Model Name', 'Quantity', 'Customer Part no', 'Outbox ID', 'LGIT Internal Model Name'

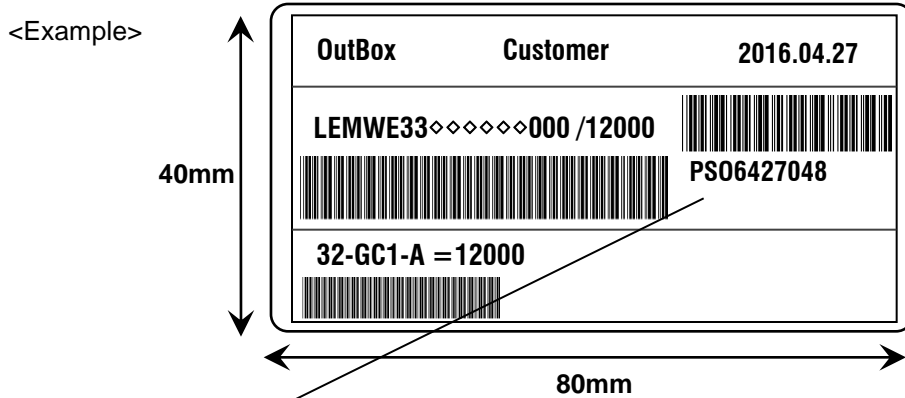

▪ Box ID. indication

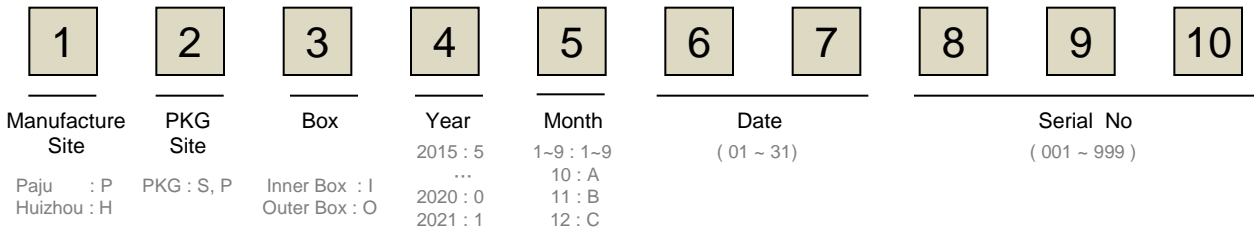

※. Label C (rank mixing case)

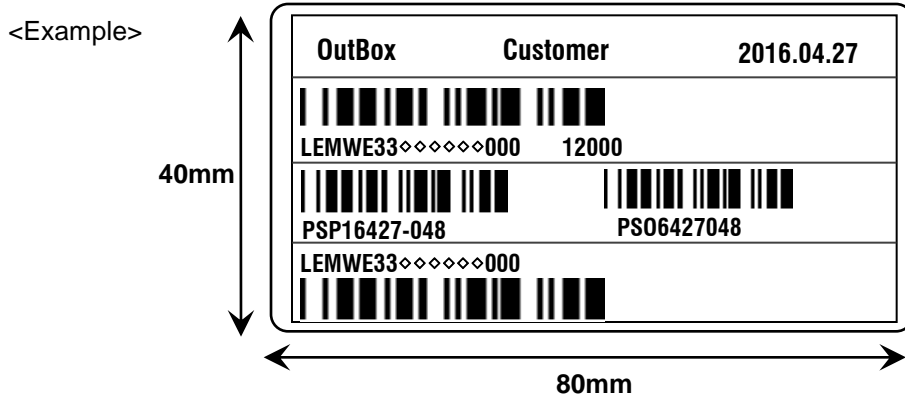

10. Packing and Labeling of Products

10-3. Packing Structures

Reeled products (Numbers of products are Max.500pcs) packed in a sealed-off and moisture-proof aluminum bag with desiccants (Silica Gel). Maximum four aluminum bags are packed in an inner box and six inner boxes are packed in an outer box. (Total Max. number of products are 12,000pcs)

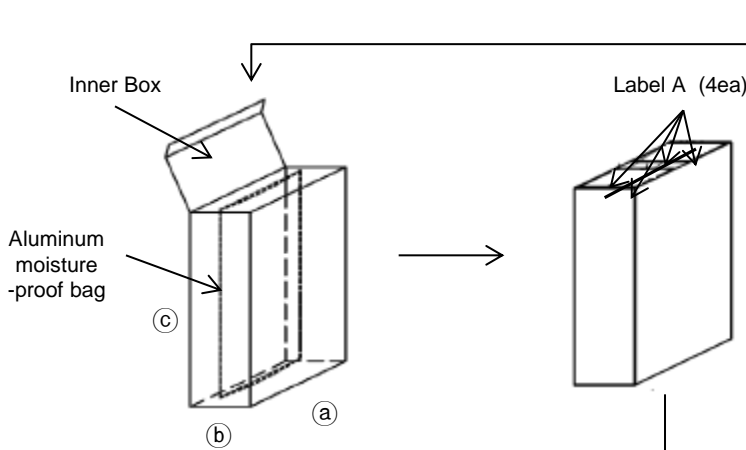
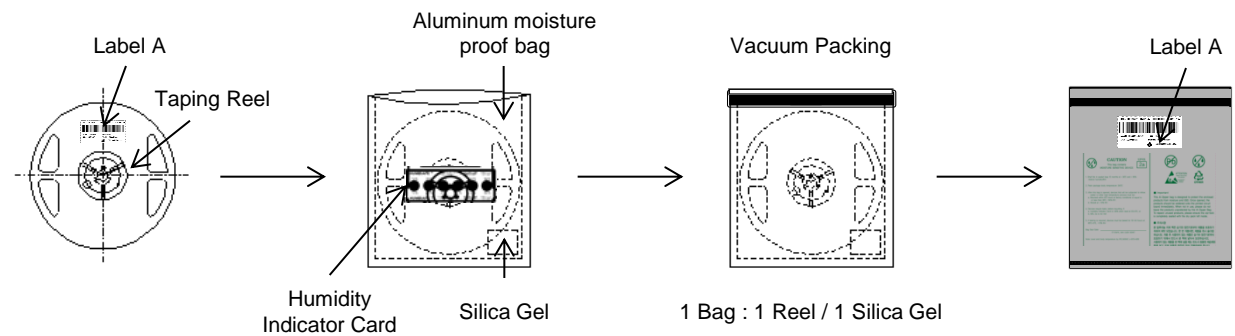

Types	Sizes (mm)		
	(a)	(b)	(c)
Inner Box	227	82	258
Outer Box	530	240	280

Tolerance : ± 10mm

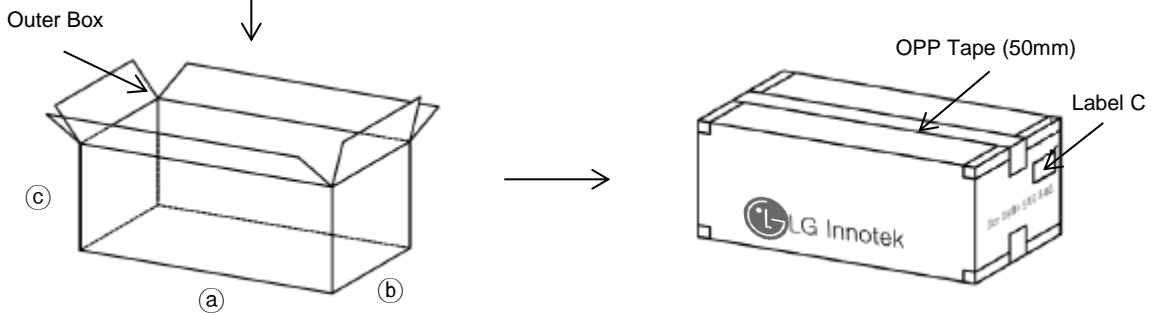

11. Cautions on Use

11-1. Moisture-Proof Package

- The moisture in the SMD package may vaporize and expand during soldering.
- The moisture can damage the optical characteristics of the LEDs due to the encapsulation.

11-2. During Storage

Conditions		Temperature	Humidity	Time
Storage	Before Opening Aluminum Bag	5°C ~ 30°C	< 50%RH	Within 1 Year from the Delivery Date
	After Opening Aluminum Bag	5°C ~ 30°C	< 60%RH	≤ 672 hours
Baking		65 ± 5°C	< 10%RH	10 ~ 24 hours

- The LEDs should be stored in a clean environment. If the LEDs are stored for 3 months or more after being shipped from LGIT, a sealed container with a nitrogen gas should be used for storage.
- When storing the LEDs after opening aluminum bag, reseal with a moisture absorbent material inside

11-3. During Usage

- The LED should be avoided direct contact with hazardous materials such as sulfur, chlorine, phthalate, acid, solvent, etc. These materials(S, Cl, VOCs, etc) may cause sulfurization of silver lead-frame or encapsulant silicone discoloration in LED.
 VOCs(Volatile Organic Compounds) can be generated from adhesives glue, cleaning flux, molding hardener or organic additive which used in luminaires fixtures and they(VOCs) may cause a significant lumen degradation of LED in luminaires when they exposed to heat or light.
 To prevent this phenomenon, materials used in luminaires must be carefully selected by users.
- The metal parts on the LED can rust when exposed to corrosive gases. Therefore, exposure to corrosive gases must be avoided during operation and storage.
- The metal parts also can be affected not only by the corrosive gases emitted inside of the end-products but by the gases penetrated from outside environment.
- Extreme environments such as sudden ambient temperature changes or high humidity that can cause condensation must be avoided.

11-4. Cleaning

- Do not use brushes for cleaning or organic solvents (i.e. Acetone, TCE, etc..) for washing as they may damage the resin of the LEDs.
- Isopropyl Alcohol(IPA) is the recommended solvent for cleaning the LEDs under the following conditions. Cleaning Condition : IPA, 25°C max. × 60sec max.
- Ultrasonic cleaning is not recommended. Pretests should be conducted with the actual cleaning process to validate that the process will not damage the LEDs.

11. Cautions on Use

11-5. Thermal Management

- The thermal design of the end product must be seriously considered, particularly at the beginning of the system design process.
- The generation of heat is greatly impacted by the input power, the thermal resistance of the circuit boards and the density of the LED array combined with other components.

11-6. Static Electricity

- Wristbands and anti-electrostatic gloves are strongly recommended and all devices, equipment and machinery must be properly grounded when handling the LEDs, which are sensitive against static electricity and surge.
- Precautions are to be taken against surge voltage to the equipment that mounts the LEDs.
- Unusual characteristics such as significant increase of current leakage, decrease of turn-on voltage, or non-operation at a low current can occur when the LED is damaged.

11-7. Recommended Circuit

- The current through each LED must not exceed the absolute maximum rating when designing the circuits.
- In general, there can be various forward voltages for LEDs. Different forward voltages in parallel via a single resistor can result in different forward currents to each LED, which also can output different luminous flux values. In the worst case, the currents can exceed the absolute maximum ratings which can stress the LEDs. Matrix circuit with a single resistor for each LED is recommended to avoid the luminous flux fluctuations.

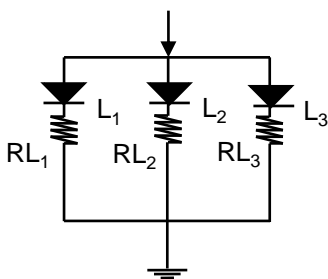

Fig.1 Recommended Circuit in Parallel Mode
: Separate resistors must be used for each LED.

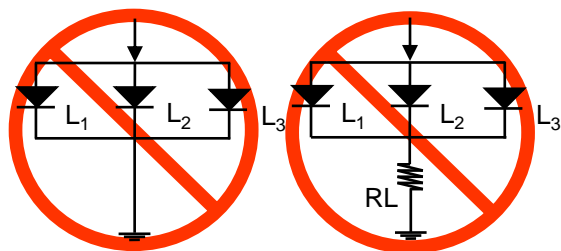

Fig.2 Abnormal Circuit
Circuits to Avoid : The current through the LEDs may vary due to the variation in LED forward voltage.

- The driving circuits must be designed to operate the LEDs by forward bias only.
- Reverse voltages can damage the zener diode, which can cause the LED to fail.
- A constant current LED driver is recommended to power the LEDs.

11. Cautions on Use

11-8. Soldering Conditions

- Reflow soldering is the recommended method for assembling LEDs on a circuit board.
- LG Innotek does not guarantee the performance of the LEDs assembled by the dip soldering method.
- Recommended Soldering Profile (according to JEDEC J-STD-020D)

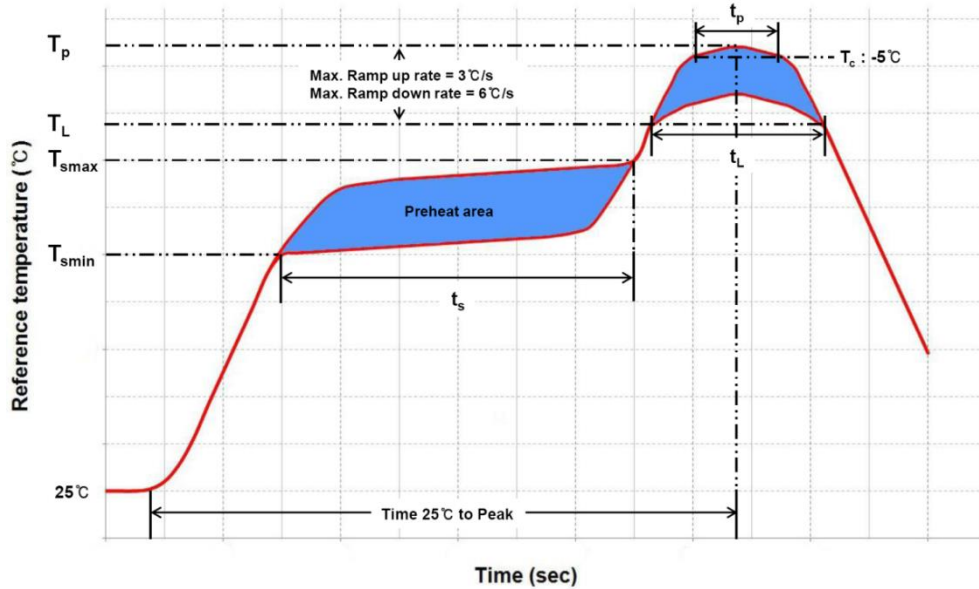

Profile Feature	Pb-Free Assembly	Pb-Based Assembly
Preheat / Soak		
Temperature Min (T_{smin})	150°C	100°C
Temperature Max (T_{smax})	200°C	150°C
Maximum time (t_s) from T_{smin} to T_{smax}	60~120 seconds	60~120 seconds
Ramp-up rate (T_L to T_p)	3°C/ second max.	3°C/ second max.
Liquidus temperature (T_L)	217°C	183°C
Time (t_L) maintained above T_L	60~150 seconds	60~150 seconds
Maximum peak package body temperature (T_p)	260°C	235°C
Time (t_p) within 5°C of the specified temperature (T_c)	30 seconds	20 seconds
Ramp-down rate (T_p to T_L)	6°C/second max.	6°C/second max.
Maximum Time 25°C to peak temperature	8 minutes max.	6 minutes max.

- Reflow or hand soldering at the lowest possible temperature is desirable for the LEDs although the recommended soldering conditions are specified in the above diagrams.
- A rapid cooling process is not recommended for the LEDs from the peak temperature.
- The silicone encapsulant at the top of the LED package is a soft surface, which can easily be damaged by pressure. Precautions should be taken to avoid strong pressure on the silicone resin when leveraging the pick and place machines.
- Reflow soldering should not be done more than two times.

11. Cautions on Use

11-9. Soldering Iron

- The recommended condition is less than 5 seconds at 260 °C.
- The time must be shorter for higher temperatures. (+10 °C → -1sec).
- The power dissipation of the soldering iron should be lower than 15W and the surface temperature of the device should be controlled at or under 230 °C.

11-10. Eye Safety Guidelines

- Do not directly look at the light when the LEDs are on.
- Proceed with caution to avoid the risk of damage to the eyes when examining the LEDs with optical instruments.

11-11. Manual Handling

- Use Teflon-type tweezers to grab the base of the LED and do not apply mechanical pressure on the surface of the encapsulant.

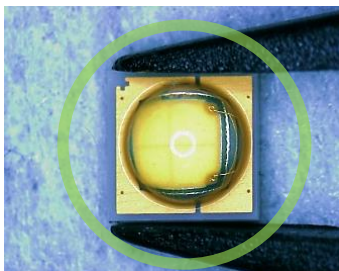

12. Disclaimers

- LG Innotek is not responsible for any damages or accidents caused if the operating or storage conditions exceed the absolute maximum ratings recommended in this document.
- The LEDs described in this document are intended to be operated by ordinary electronic equipment.
- The LEDs should not be used at any lighting products together with the other LEDs, which has a different part number. If required, please contact any sales person.
- It is recommended to consult with LG Innotek when the environment or the LED operation is non-standard in order to avoid any possible malfunctions or damage to product or risk of life or health.
- Disassembly of the LED products for the purpose of reverse engineering is prohibited without prior written consent from LG Innotek. All defected LEDs must be reported to LG Innotek and are not to be disassembled or analyzed.
- The product information can be modified and upgraded without prior notice.

13. Package Nomenclature

All LEDs are tested and sorted by color, luminous flux and forward voltage where every LED in a reel has only a single color bin, luminous flux bin and forward voltage bin. However, the forward voltage bin information is not captured in the part number nomenclature.

A 16-digit part number is required when orders are placed. LG Innotek leverages the following part number nomenclature.

