



STK405-120

2ch AF Power Amplifier (Split Power Supply) (80W + 80W min, THD = 10%)

Overview

The STK405-120, a member of the STK405-000 series, is a low-cost, 2-channel audio power amplifier hybrid IC that is ideal for a wide range of stereo sets. It has dedicated 6Ω output drive, in contrast with the STK401-000 series which supports 6Ω/3Ω output drive.

Features

- Class B amplifiers
- Output load impedance $R_L=6\Omega$ support
- EIAJ-output compatible ($f=1\text{kHz}$, $\text{THD}=10\%$)
- Low supply switching shock noise
- Pin assignment grouped into individual blocks of inputs, outputs and supply lines to minimize the adverse effects of pattern layout on operating characteristics
- External bootstrap circuit not necessary
- Standby operation possible using external circuit
- Voltage gain $V_G=26\text{dB}$ for easy gain distribution within the set
- Member of 10W/ch to 80W/ch pin-compatible series

Series Organization

The following devices form a series with differing output capacity. Some of the following devices are under development. Contact your Sanyo sales representative if you require more detailed information.

Type No.	Output power	Supply voltage [V]	
		$V_{CC\text{ max}}$	V_{CC}
STK405-010	10W + 10W	± 26.0	± 14.0
STK405-030	20W + 20W	± 30.5	± 18.5
STK405-050	30W + 30W	± 34.5	± 22.0
STK405-070	40W + 40W	± 39.0	± 25.0
STK405-090	50W + 50W	± 42.0	± 26.5
STK405-100	60W + 60W	± 45.0	± 29.0
STK405-110	70W + 70W	± 50.0	± 31.0
STK405-120	80W + 80W	± 52.5	± 33.0

Package Dimensions

unit:mm

4162

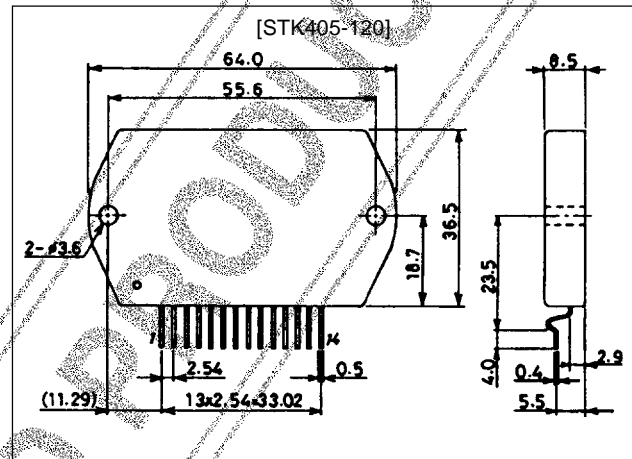

■ Any and all SANYO products described or contained herein do not have specifications that can handle applications that require extremely high levels of reliability, such as life-support systems, aircraft's control systems, or other applications whose failure can be reasonably expected to result in serious physical and/or material damage. Consult with your SANYO representative nearest you before using any SANYO products described or contained herein in such applications.

■ SANYO assumes no responsibility for equipment failures that result from using products at values that exceed, even momentarily, rated values (such as maximum ratings, operating condition ranges, or other parameters) listed in products specifications of any and all SANYO products described or contained herein.

SANYO Electric Co.,Ltd. Semiconductor Company

TOKYO OFFICE Tokyo Bldg., 1-10, 1 Chome, Ueno, Taito-ku, TOKYO, 110-8534 JAPAN

Specifications

Maximum Ratings at $T_a = 25^\circ\text{C}$

Parameter	Symbol	Conditions	Ratings	Unit
Maximum supply voltage	$V_{CC\text{ max}}$		± 52.5	V
Thermal resistance	θ_{j-c}	Per power transistor	1.8	$^\circ\text{C/W}$
Junction temperature	T_j		150	$^\circ\text{C}$
Operating temperature	T_c		125	$^\circ\text{C}$
Storage temperature	T_{stg}		-30 to +125	$^\circ\text{C}$
Available time for load short-circuit	t_s	$V_{CC}=\pm 33.0\text{V}$, $R_L=6\Omega$, $f=50\text{Hz}$, $P_O=80\text{W}$	1	s

Operating Characteristics at $T_a = 25^\circ\text{C}$, $R_L=6\Omega$ (noninductive load), $R_g=600\Omega$, $V_G=26\text{dB}$

Parameter	Symbol	Conditions	Ratings			Unit
			min	typ	max	
Quiescent current	I_{CCO}	$V_{CC}=\pm 42.0\text{V}$, no load		13	20	mA
Output power	P_O	$V_{CC}=\pm 33.0\text{V}$, $f=1\text{kHz}$, $\text{THD}=10.0\%$	80			W
Total harmonic distortion	THD	$V_{CC}=\pm 33.0\text{V}$, $f=1\text{kHz}$, $P_O=5.0\text{W}$		0.04	0.1	%
Frequency response	f_L, f_H	$V_{CC}=\pm 33.0\text{V}$, $P_O=1.0\text{W}$, $+0$ -3 dB		20 to 50k		Hz
Input impedance	r_i	$V_{CC}=\pm 33.0\text{V}$, $f=1\text{kHz}$, $P_O=1.0\text{W}$		55		k Ω
Output noise voltage	V_{NO}	$V_{CC}=\pm 42.0\text{V}$, $R_g=10\text{k}\Omega$			1.2	mVrms
Neutral voltage	V_N	$V_{CC}=\pm 42.0\text{V}$	-100	0	+100	mV

Note.

All tests are measured using a constant-voltage supply unless otherwise specified.

Available time for load short-circuit and output noise voltage are measured using the transformer supply specified below. The output noise voltage is the peak value of an average-reading meter with an rms value scale (VTVM). A regulated AC supply (50Hz) should be used to eliminate the effects of AC primary line flicker noise.

Specified Transformer Supply (MG-200 or Equivalent)

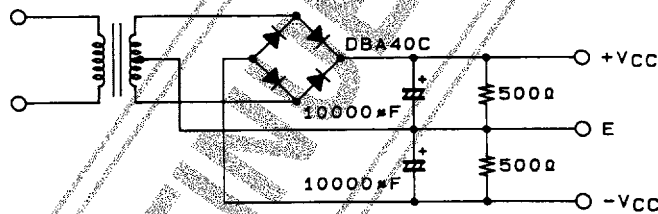

A04167

DISCONTINUED PRODUCT

STK405-120

Block Diagram

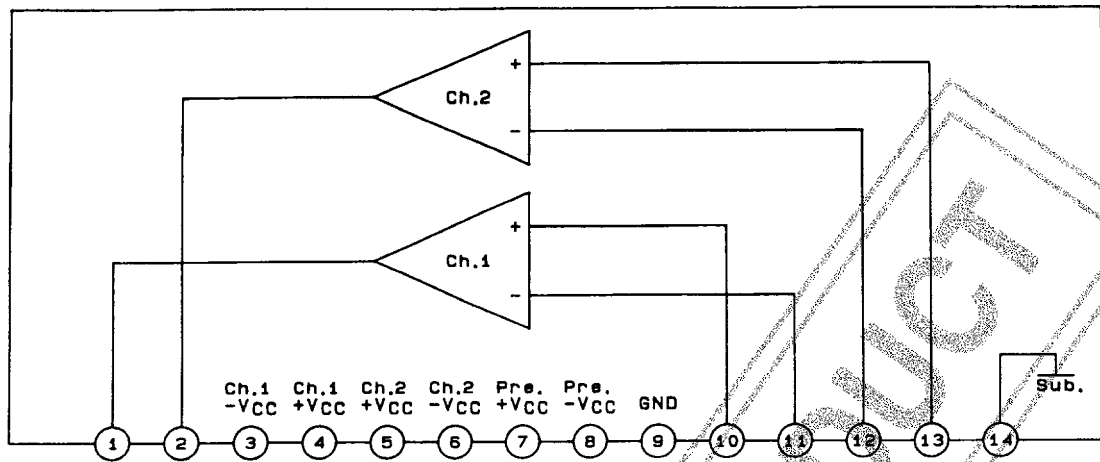

Test Circuit

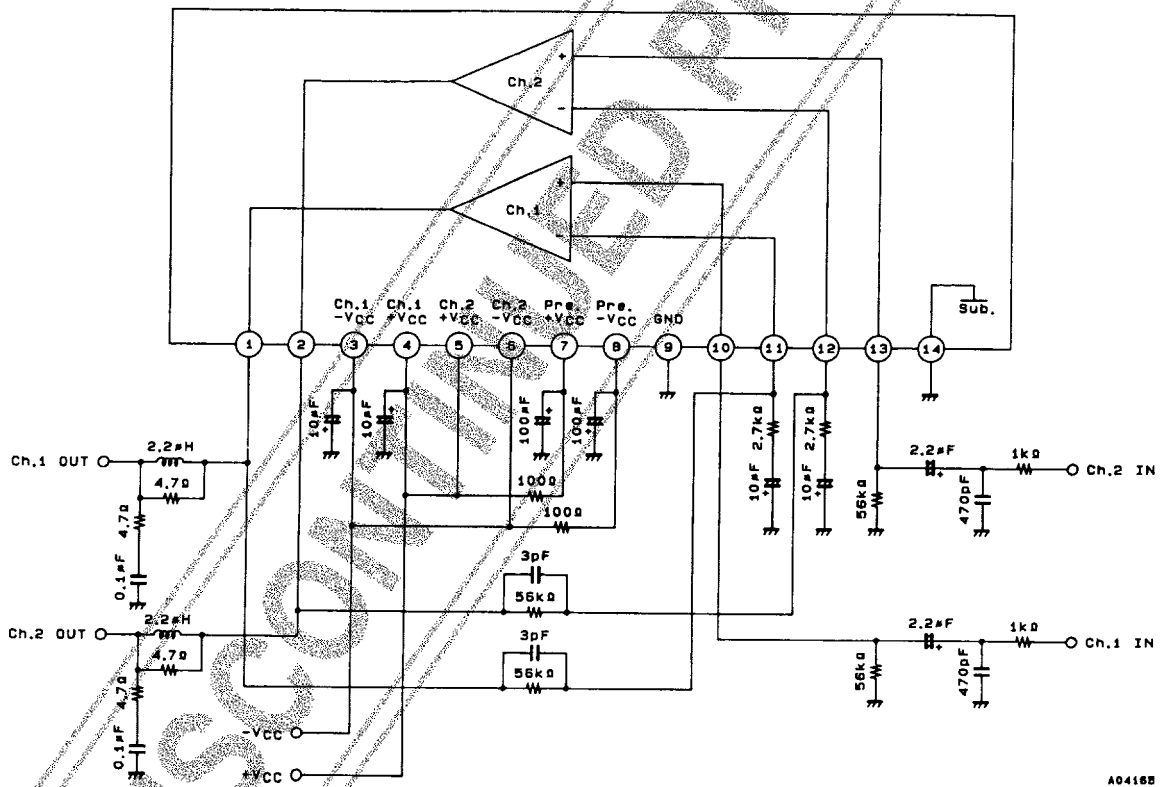

Sample Application Circuit (Standby Mode Supported)

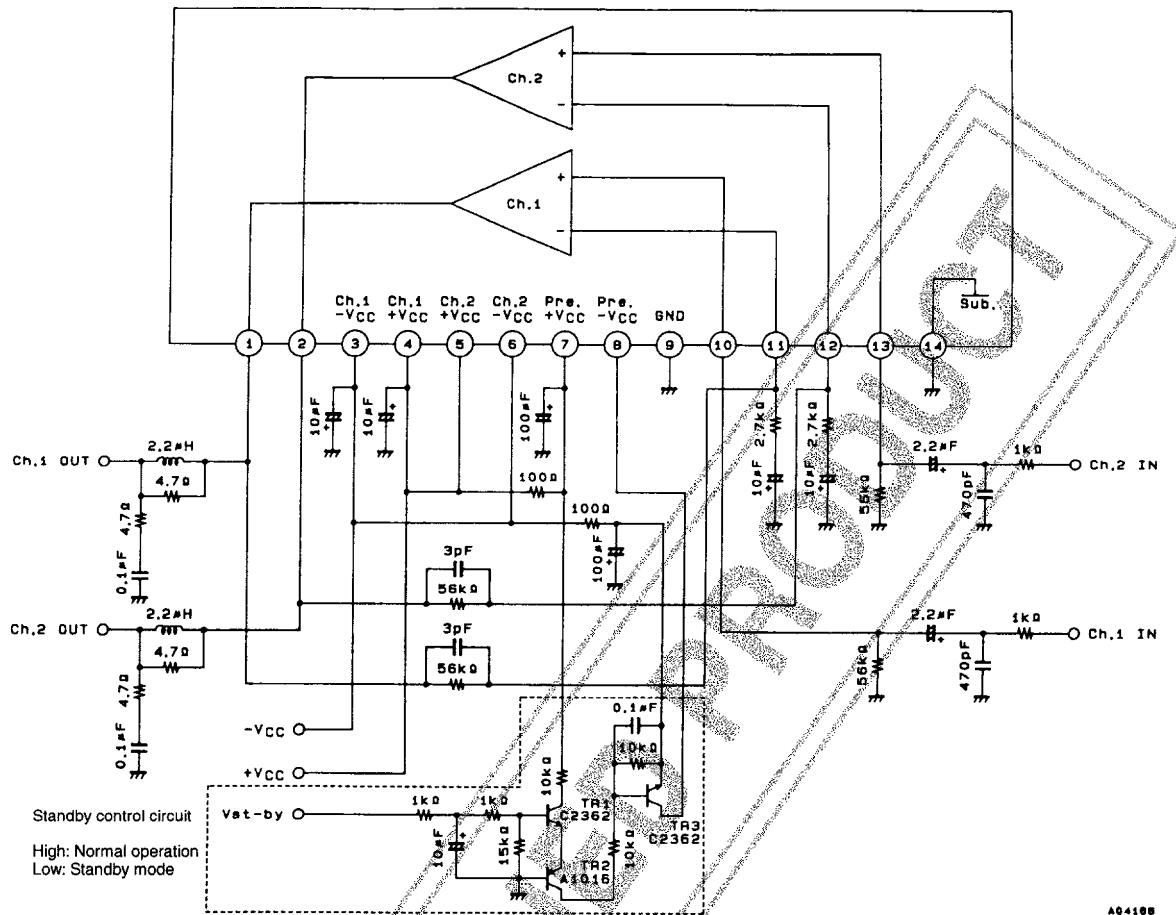

Heatsink Design Considerations

The heatsink thermal resistance, θ_{c-a} , required to dissipate the STK405-120 device total power dissipation, P_d , is determined as follows :

Condition 1: IC substrate temperature not to exceed 125°C
 $P_d \times \theta_{c-a} + T_a < 125^\circ\text{C}$ (1)

Where T_a is the guaranteed maximum ambient temperature.

Condition 2: Power transistor junction temperature, T_j , not to exceed 150°C
 $P_d \times \theta_{c-a} + P_d / N \times \theta_{j-c} + T_a < 150^\circ\text{C}$ (2)

where N is the number of power transistors and θ_{j-c} is the power transistor thermal resistance per transistor. Note that the power dissipated per transistor is the total, P_d , divided evenly among the N power transistors.

Expressions (1) and (2) can be rewritten making θ_{c-a} the subject.

$\theta_{c-a} < (125 - T_a) / P_d$ (1')

$\theta_{c-a} < (150 - T_a) / P_d - \theta_{j-c} / N$ (2')

The heatsink required must have a thermal resistance that simultaneously satisfied both expressions.

The heatsink thermal resistance can be determined from (1)' and (2)' once the following parameters have been defined.

- Supply voltage : V_{CC}
- Load resistance : R_L
- Guaranteed maximum ambient temperature : T_a

The total device power dissipation when STK405-120 $V_{CC} = \pm 33.0\text{V}$ and $R_L = 6\Omega$, for a continuous sine wave signal, is a maximum of 74W, as shown in the $P_d - P_O$ characteristics graph.

When estimating the power dissipation for an actual audio signal input, the rule of thumb is to select P_d corresponding to 1/10 P_O max (within safe limits) for a continuous sine wave input. For example,

$P_d = 53\text{W}$ [for 1/10 P_O max = 8W]

The STK405-120 has 4 power transistors, and the thermal resistance per transistor, θ_{j-c} , is 1.8°C/W. If the granted maximum ambient temperature, T_a , is 50°C, then the required heatsink thermal resistance, θ_{c-a} , is :

STK405-120

From expression (1)' : $\theta_{c-a} < (125-50)/53$
 < 1.41

From expression (2)' : $\theta_{c-a} < (150-50)/53-1.8/4$
 < 1.43

Therefore, to satisfy both expressions, the required heatsink must have a thermal resistance less than $1.41^{\circ}\text{C}/\text{W}$.

The heatsink design example is based on a constant-voltage supply, and should be verified within your specific set environment.

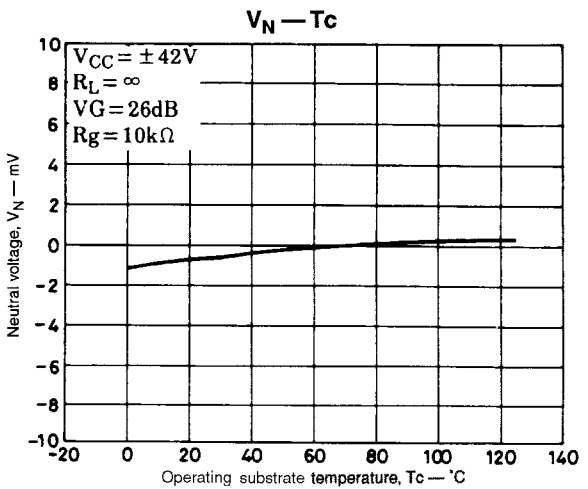
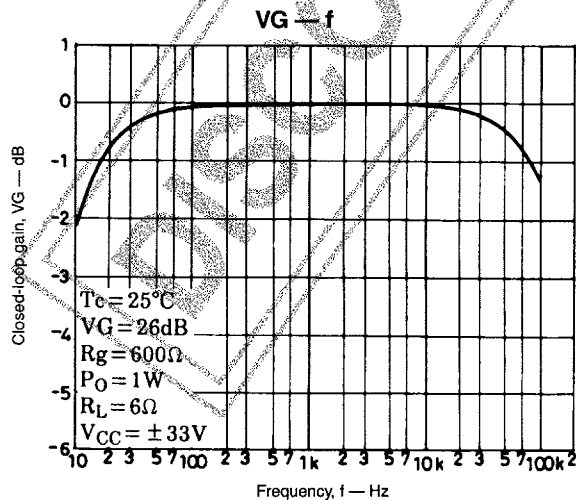
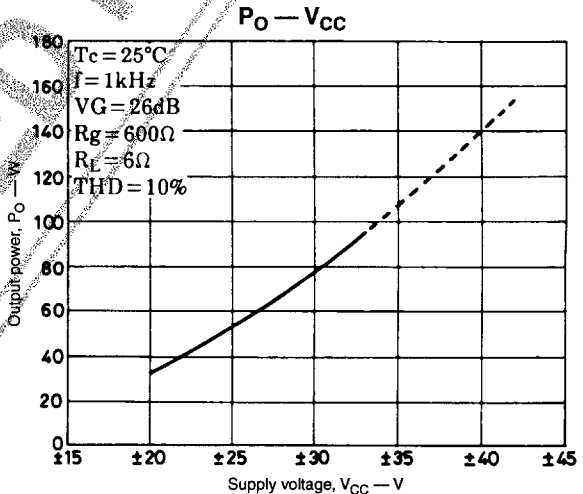
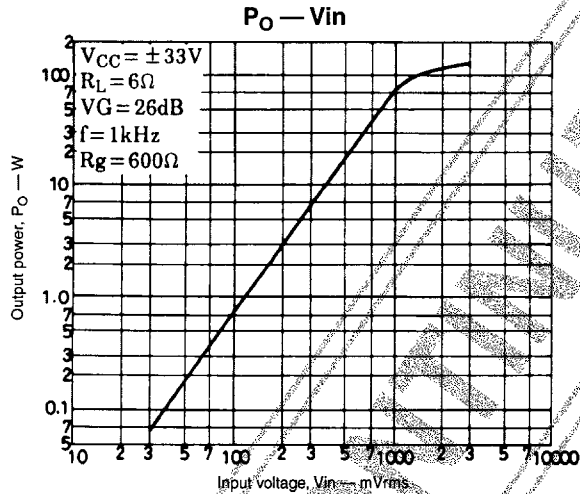
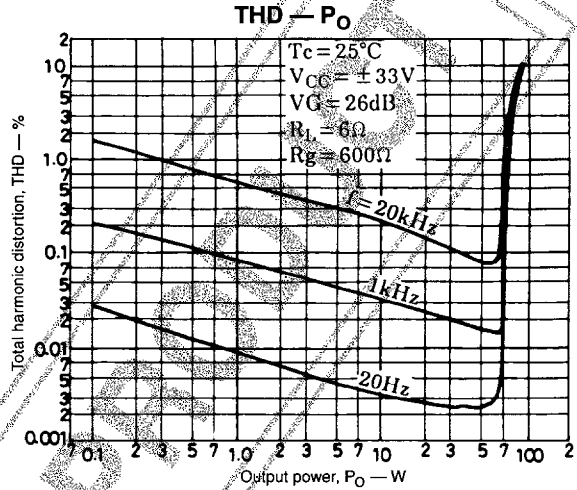
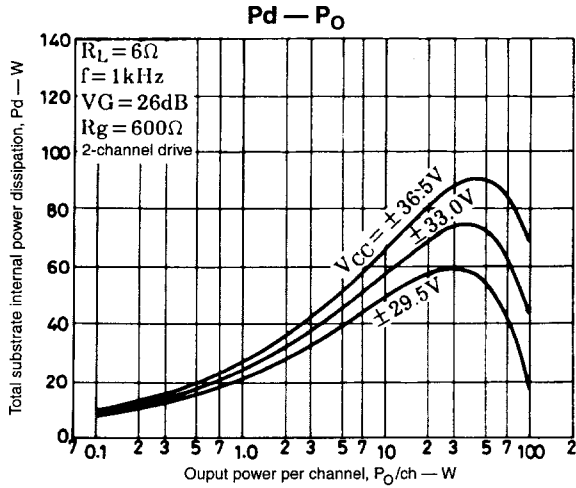

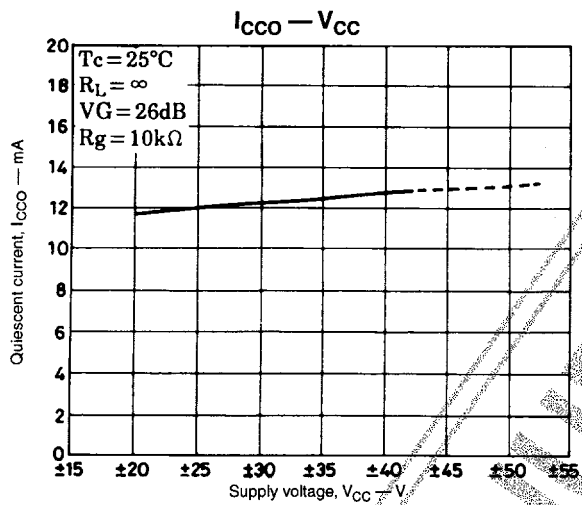
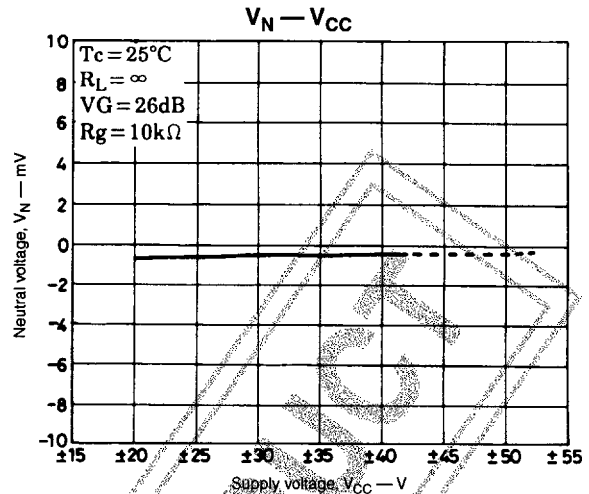
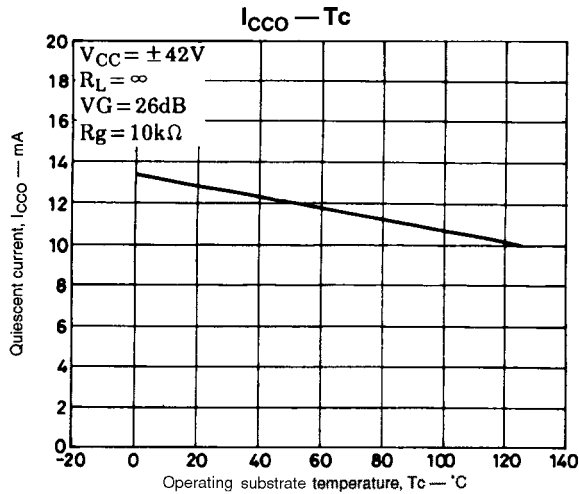

- Specifications of any and all SANYO products described or contained herein stipulate the performance, characteristics, and functions of the described products in the independent state, and are not guarantees of the performance, characteristics, and functions of the described products as mounted in the customer's products or equipment. To verify symptoms and states that cannot be evaluated in an independent device, the customer should always evaluate and test devices mounted in the customer's products or equipment.
- SANYO Electric Co., Ltd. strives to supply high-quality high-reliability products. However, any and all semiconductor products fail with some probability. It is possible that these probabilistic failures could give rise to accidents or events that could endanger human lives, that could give rise to smoke or fire, or that could cause damage to other property. When designing equipment, adopt safety measures so that these kinds of accidents or events cannot occur. Such measures include but are not limited to protective circuits and error prevention circuits for safe design, redundant design, and structural design.
- In the event that any or all SANYO products (including technical data, services) described or contained herein are controlled under any of applicable local export control laws and regulations, such products must not be exported without obtaining the export license from the authorities concerned in accordance with the above law.
- No part of this publication may be reproduced or transmitted in any form or by any means, electronic or mechanical, including photocopying and recording, or any information storage or retrieval system, or otherwise, without the prior written permission of SANYO Electric Co., Ltd.
- Any and all information described or contained herein are subject to change without notice due to product/technology improvement, etc. When designing equipment, refer to the "Delivery Specification" for the SANYO product that you intend to use.
- Information (including circuit diagrams and circuit parameters) herein is for example only; it is not guaranteed for volume production. SANYO believes information herein is accurate and reliable, but no guarantees are made or implied regarding its use or any infringements of intellectual property rights or other rights of third parties.

This catalog provides information as of October, 1999. Specifications and information herein are subject to change without notice.