

1W Isolated DC-DC converter  
Fixed input voltage, unregulated single output



### FEATURES

- Continuous short-circuit protection
- No-load input current as low as 8mA
- Operating ambient temperature range: -40°C to +105°C
- High efficiency up to 85%
- Compact SMD package
- I/O isolation test voltage: 3k VDC
- Industry standard pin-out

Report **UKCA** Report **CB** **RoHS** Patent Protection  
 UL 62368-1 EN 62368-1 BS EN 62368-1 IEC 62368-1

*F\_XT-1WR3 series are specially designed for applications where an isolated voltage is required in a distributed power supply system. They are suitable for: pure digital circuits, low frequency analog circuits, relay-driven circuits and data switching circuits.*

### Selection Guide

Certification	Part No.	Input Voltage (VDC)	Output		Full Load Efficiency (%) Min./Typ.	Capacitive Load(μF) Max.
		Nominal (Range)	Voltage (VDC)	Current (mA) Max./Min.		
EN/BS EN	F1203XT-1WR3	12 (10.8-13.2)	3.3	303/30	72/76	2400
UL/EN/BS EN/IEC	F1205XT-1WR3		5	200/20	78/82	2400
	F1209XT-1WR3		9	111/12	79/83	1000
	F1212XT-1WR3		12	84/9	79/83	560
	F1215XT-1WR3		15	67/7	79/83	560
	F1224XT-1WR3		24	42/4	81/85	220
EN/BS EN	F1509XT-1WR3	15 (13.5-16.5)	5	200/20	78/82	2400
UL/EN/BS EN/IEC	F1515XT-1WR3		9	111/12	78/82	1000
EN/BS EN	F1515XT-1WR3	24 (21.6-26.4)	15	67/7	79/83	560
UL/EN/BS EN/IEC	F2403XT-1WR3		3.3	303/30	72/76	2400
	F2405XT-1WR3		5	200/20	74/80	2400
	F2409XT-1WR3		9	111/12	74/80	1000
	F2412XT-1WR3		12	84/9	74/80	560
	F2415XT-1WR3		15	67/7	74/80	560
F2424XT-1WR3	24	42/4	74/80	220		

### Input Specifications

Item	Operating Conditions		Min.	Typ.	Max.	Unit		
Input Current (full load / no-load)	12VDC input	3.3VDC output	--	110/8	116/--	mA		
		5VDC output	--	102/8	107/--			
		9VDC/12VDC/15VDC output	--	101/8	106/--			
		24VDC output	--	99/8	103/--			
	15VDC input	5VDC/9VDC output	--	82/8	86/--			
		15VDC output	--	81/8	85/--			
	24VDC input	3.3VDC output	--	55/8	58/--			
		5VDC output	--	53/8	57/--			
		9VDC/12VDC/15VDC output	--	51/8	55/--			
		24VDC output	--	53/8	57/--			
	Reflected Ripple Current*			--	15		--	

Surge Voltage(1sec. max.)	12VDC input	-0.7	--	18	VDC
	15VDC input	-0.7	--	21	
	24VDC input	-0.7	--	30	
Input Filter		Capacitance filter			
Hot Plug		Unavailable			
Note: * Refer to DC-DC Converter Application Notes for detailed description of reflected ripple current test method.					

## Output Specifications

Item	Operating Conditions	Min.	Typ.	Max.	Unit	
Voltage Accuracy		See output regulation curves (Fig. 1)				
Linear Regulation	Input voltage change: $\pm 1\%$	3.3V output	--	--	$\pm 1.5$	--
		Other output	--	--	$\pm 1.2$	
Load Regulation	10%-100% load	3.3DC output	--	8	20	%
		5VDC output	--	5	15	
		9VDC output	--	3	10	
		12VDC output	--	3	10	
		15VDC output	--	3	10	
		24VDC output	--	2	10	
Ripple & Noise*	20MHz bandwidth	3.3VDC/5VDC/9VDC/ 12VDC/15VDC output	--	30	75	mVp-p
		24VDC output	--	50	100	
Temperature Coefficient	Full load	--	$\pm 0.02$	--	%/°C	
Short-Circuit Protection		Continuous, self-recovery				
Notes: * The "parallel cable" method is used for Ripple and Noise test, please refer to DC-DC Converter Application Notes for specific information.						

## General Specifications

Item	Operating Conditions	Min.	Typ.	Max.	Unit
Isolation	Input-output electric strength test for 1 minute with a leakage current of 1mA max.	3000	--	--	VDC
Insulation Resistance	Input-output resistance at 500VDC	1000	--	--	M $\Omega$
Isolation Capacitance	Input-output capacitance at 100kHz/0.1V	--	20	--	pF
Operating Temperature	Derating when operating temperature $\geq 100^\circ\text{C}$ , (see Fig. 2)	-40	--	105	°C
Storage Temperature		-55	--	125	
Case Temperature Rise	Ta=25°C	--	25	--	
Storage Humidity	Non-condensing	5	--	95	%RH
Reflow Soldering Temperature*		Peak temp. $\leq 245^\circ\text{C}$ , maximum duration time $\leq 60\text{s}$ over $217^\circ\text{C}$ .			
Vibration		10-150Hz, 5G, 0.75mm. along X, Y and Z			
Switching Frequency	Full load, nominal input voltage	--	260	--	kHz
MTBF	MIL-HDBK-217F@25°C	3500	--	--	k hours
Moisture Sensitivity Level (MSL)	IPC/JEDEC J-STD-020D.1	Level 1			
Note:*For actual application, please refer to IPC/JEDEC J-STD-020D.1.					

## Mechanical Specifications

Case Material	Black plastic; flame-retardant and heat-resistant (UL94V-0)
Dimensions	13.20 x 11.40 x 7.25 mm
Weight	1.4g(Typ.)
Cooling Method	Free air convection

Electromagnetic Compatibility (EMC)

Emissions	CE	CISPR32/EN55032	CLASS B
	RE	CISPR32/EN55032	CLASS B
Immunity	ESD	IEC/EN61000-4-2	Air ±8kV, Contact ±6kV perf. Criteria B

Note: Refer to Fig.4 for recommended circuit test.

Typical Performance Curves

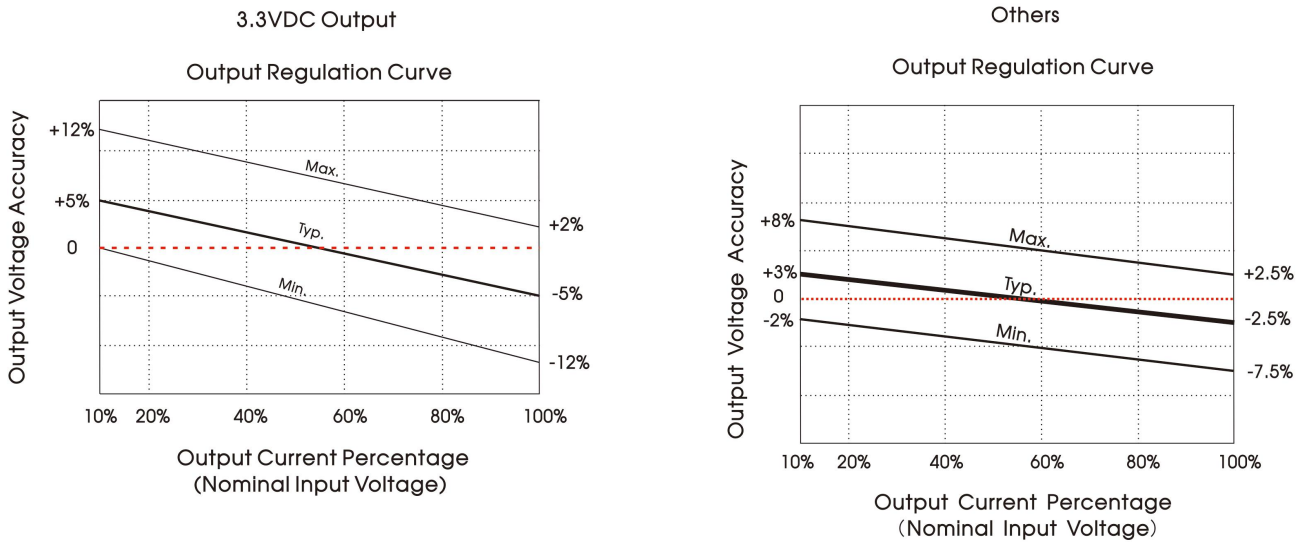

Fig. 1

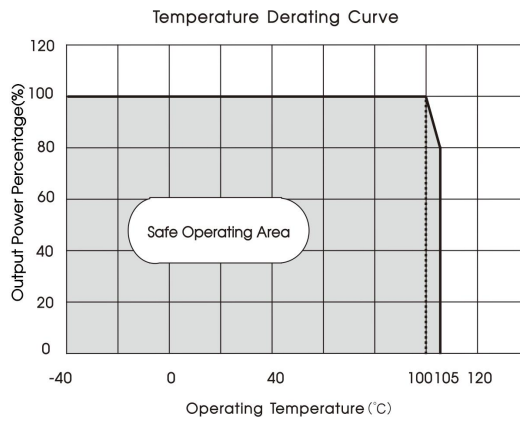
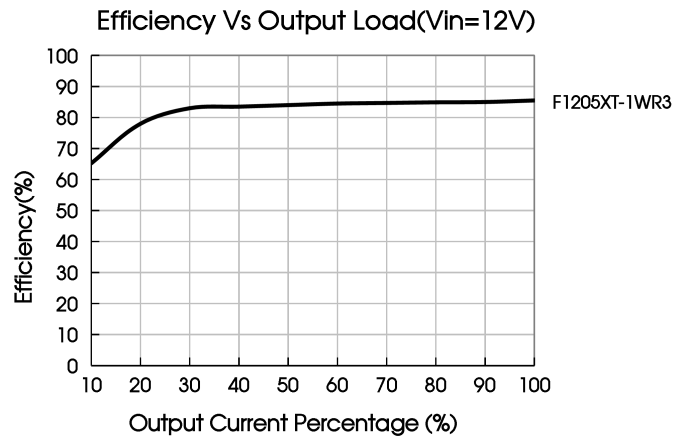
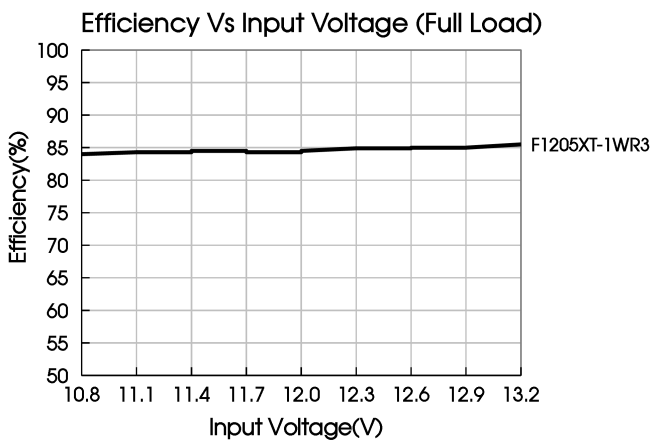
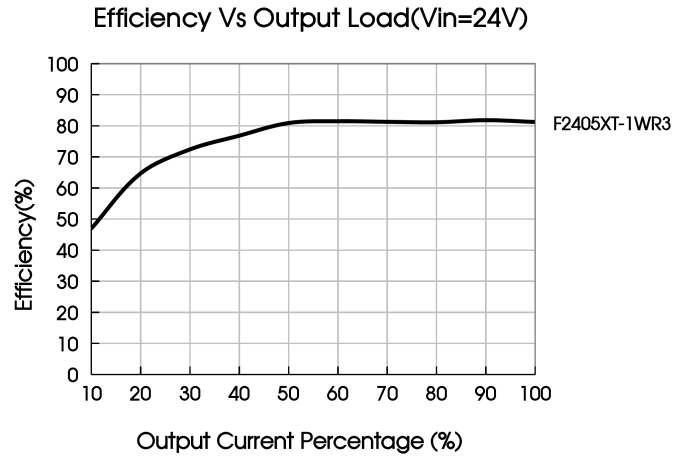
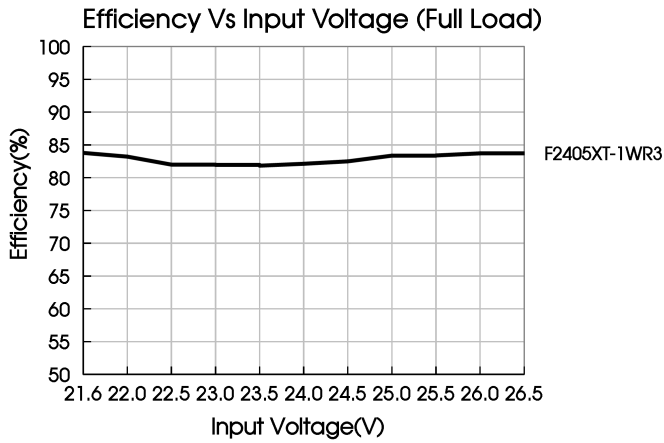

Fig. 2





## Design Reference

### 1. Typical application

Input and/or output ripple can be further reduced, by connecting a filter capacitor from the input and/or output terminals to ground as shown in Fig. 3.

Choosing suitable filter capacitor values is very important for a smooth operation of the modules, particularly to avoid start-up problems caused by capacitor values that are too high. For recommended input and output capacitor values refer to Table 1.

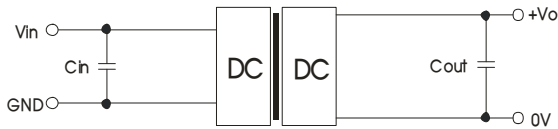

Fig. 3

Table 1: Recommended input and output capacitor values

Vin	Cin	Vo	Cout
12VDC	2.2μF/25V	3.3VDC/5VDC	10μF/16V
15VDC	2.2μF/25V	9VDC	2.2μF/16V
24VDC	1μF/50V	12VDC	2.2μF/25V
--	--	15VDC	1μF/25V
--	--	24VDC	1μF/50V

### 2. EMC compliance circuit

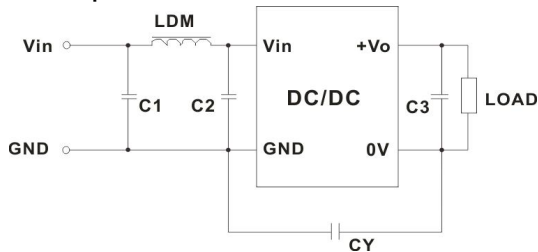

Fig. 4

Table 2: EMC recommended circuit value table

Emissions	C1/C2	4.7μF /50V
	CY	270pF /3kV
	C3	Refer to the Cout in table 1
	LDM	6.8μH

3. For additional information please refer to DC-DC converter application notes on

[www.mornsun-power.com](http://www.mornsun-power.com)

Dimensions and Recommended Layout

THIRD ANGLE PROJECTION

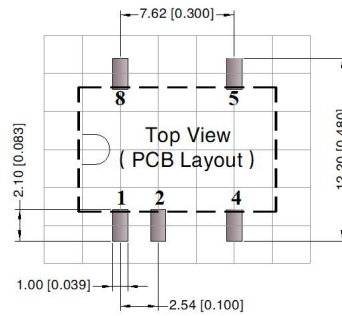
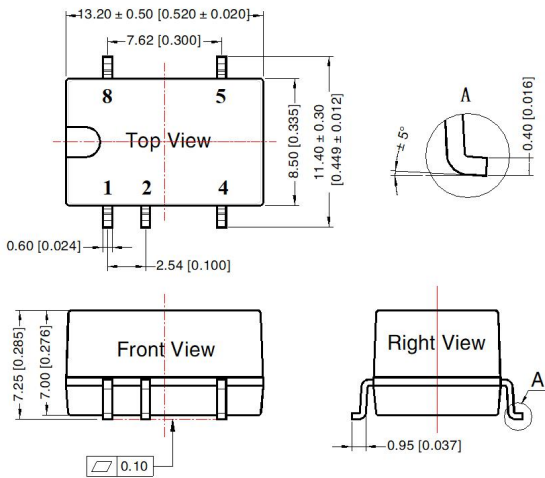

Note: Grid 2.54\*2.54mm

Pin-Out	
Pin	Mark
1	GND
2	Vin
4	0V
5	+Vo
8	NC

NC: Pin to be isolated from circuitry

Note:  
Unit: mm[inch]  
Pin section tolerances: ± 0.10[± 0.004]  
General tolerances: ± 0.25[± 0.010]

Tape and Reel Info

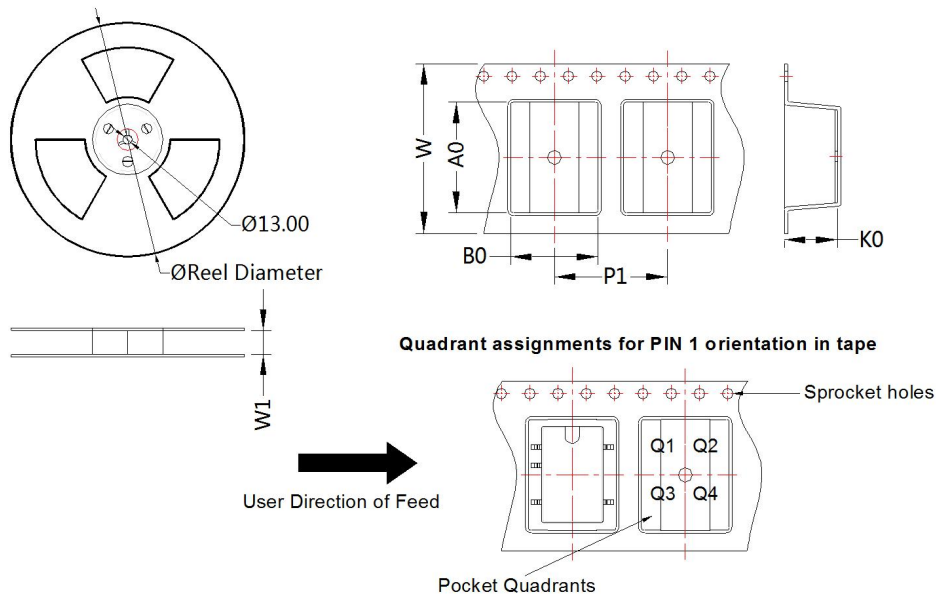

Device	Package Type	Pin	SPQ	Reel Diameter (mm)	Reel Width W1 (mm)	A0 (mm)	B0 (mm)	K0 (mm)	P1 (mm)	W (mm)	Pin1 Quadrant
F_XT-1WR3	SMD	5	500	330.0	24.5	13.4	11.7	7.5	16.0	24.0	Q1

Notes:

1. For additional information on Product Packaging please refer to [www.mornsun-power.com](http://www.mornsun-power.com). Tube Packaging bag number: 58210024, Roll Packaging bag number: 58200054;
2. If the product is not operated within the required load range, the product performance cannot be guaranteed to comply with all parameters in the datasheet;
3. The maximum capacitive load offered were tested at input voltage range and full load;
4. Unless otherwise specified, parameters in this datasheet were measured under the conditions of  $T_a=25^{\circ}\text{C}$ , humidity<75%RH with nominal input voltage and rated output load;
5. All index testing methods in this datasheet are based on our company corporate standards;
6. We can provide product customization service, please contact our technicians directly for specific information;
7. Products are related to laws and regulations: see "Features" and "EMC";
8. Our products shall be classified according to ISO14001 and related environmental laws and regulations, and shall be handled by qualified units.

MORNSUN Guangzhou Science & Technology Co., Ltd.

Address: No. 5, Kehui St. 1, Kehui Development Center, Science Ave., Guangzhou Science City, Huangpu District, Guangzhou, P. R. China  
Tel: 86-20-38601850 Fax: 86-20-38601272 E-mail: [info@mornsun.cn](mailto:info@mornsun.cn) [www.mornsun-power.com](http://www.mornsun-power.com)