

Data sheet

Commercial Art.No.: 96.232.6004.1

Cable assembly RST20i3K1-S 15P 60SW

RST20i3 connection cable male - free end, 3 pole, assembled with shrinkage tube, application 250V with PE, 16A, cable type H05VV-F, length 6.0m, cross section 1.5mm², coding color black



Commercial Art.No.	96.232.6004.1
EAN	4015573761483
Order Unit	1

Certificates / Approvals



Technical data

General

Rated current	16 A
Rated voltage	250 V
Rated impulse voltage	4 kV
Pollution degree	3
Lockable	self-locking (unlocking by tool)
Color of coding/ contact carrier	black
Marking of poles	L, N, PE
Color of housing inclusive strain relief	black

Model

type of construction	Shrinkage tube
Connection type	Crimp
Nominal cross section conductor	1.5 mm ²
Degree of protection (IP)	IP66/68 (3m;2h)
Wire strip length	9 mm
sheath strip length	35 mm
Preparation of conductor ends	ultrasonically compressed wire ends
Cable type	H05VV-F
Cable color	black
Cable diameter min.	8.15 mm
Cable diameter max.	8.45 mm
Version of cable	male - free end
Type of cord set	connection cable

Version cable end 1	free end
Version cable end 2	male
Shielded	No

Material

Surface finish	Silver-plated
halogen free	No
Continuous temperature of cable	70 °C
Insulation components continuous temperature	100 °C
Fire load	2.352 kWh
Fire class	Eca

Dimensions

Total length	6 m
--------------	-----

Classification

ECLASS 11	
ECLASS 8.1	27440604
ETIM 7.0	EC002587
ETIM 6.0	EC002587
ETIM 5.0	EC002587
ETIM 4.0	EC002587

Note

Note	The total length may vary up to + / - 3 %.
------	--

Product compliance

ROHS conformity status	Compliant/Exempted
ROHS exceptions	III-6(c)
REACH-SVHC conformity status	Duty-To-Declare
REACH-SVHC substances	Lead
REACH-SVHC CAS numbers	7439-92-1

These dimensions will be especially checked at delivery
 Only inspection dimensions
 With /E marked dimensions are only valid for internal use

Diese Maße werden bei Abnahme besonders geprüft
 Ausschließlich Prüfmaße
 Mit /E gekennzeichnete Maße sind nur für interne Zwecke gültig

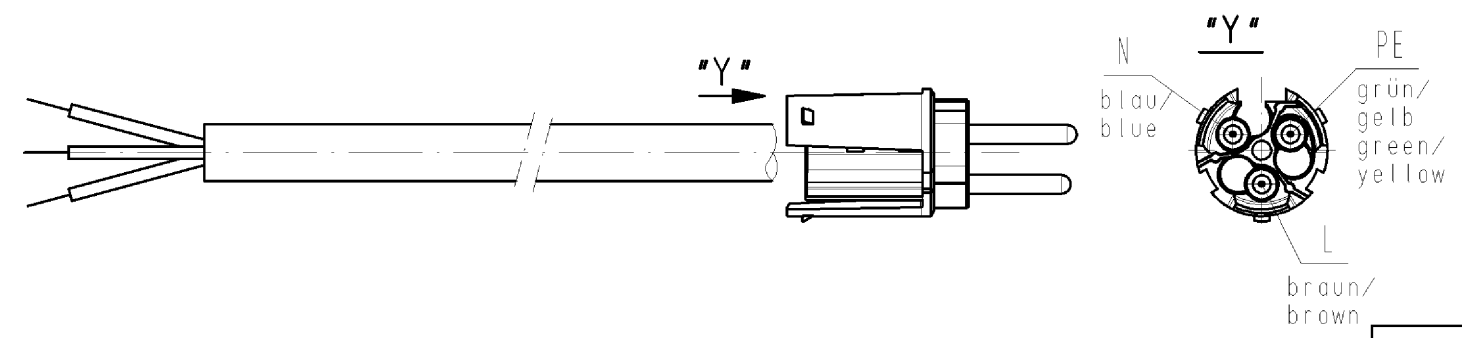
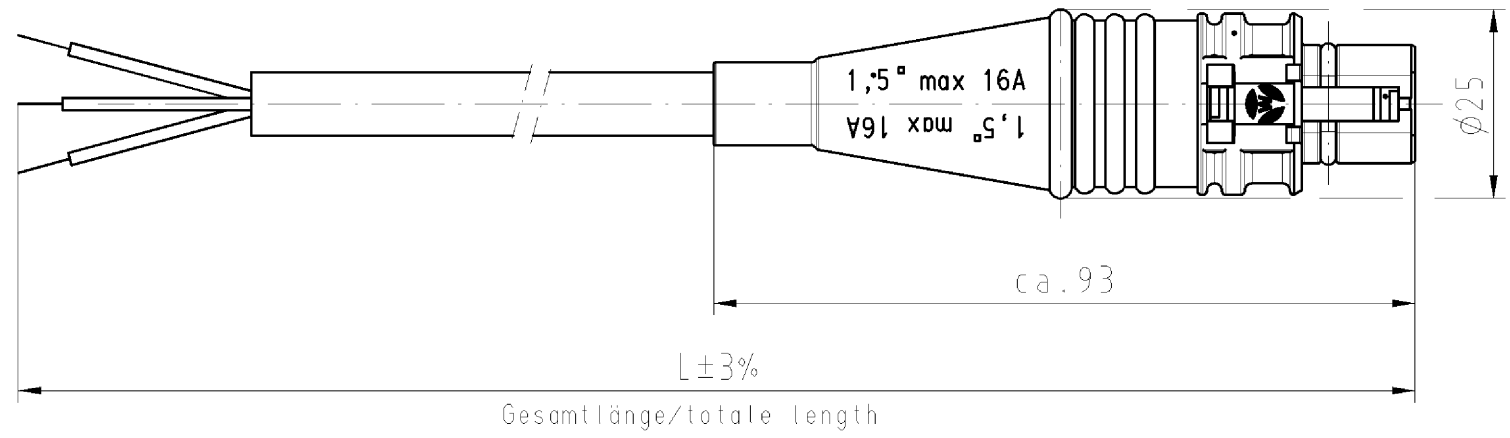

.F	Farbe colour	Codierung "P" Stecker male	Verriegelung locking
.0	lichtgrau light grey	PE N	05.583.2 schwarz
.1	schwarz black	L	05.583.2 betongr concrete

Weitergabe sowie Vervielfältigung dieses Dokuments, Verwechslung und
 seines Inhalts sind verboten, soweit nicht ausdrücklich gestattet.
 The reproduction, distribution and utilization of this document as well as the
 communication of its contents to others without express authorization is prohibited.

Farbe/color	.F
schwarz/black	.1
lichtgrau/light grey	.0

Teile-Nr. part-no.	L	Beispiel (Farbe: schwarz, lichtgrau) example (colour: black, grey)	Typ type
96.232.XX04.1	XX in dm-Schritten	96.232.1004.1 = 10dm/L= 1000mm	RST2013K1-S 15P 10SW
96.232.XX04.0		96.232.1004.0	RST2013K1-S 15P 10GL
U6.232.XX04.1	XX in m-Schritten	U6.232.1204.1 = 12 m/L=12000mm	RST2013K1-S 15P X12SW
U6.232.XX04.0		U6.232.1204.0	RST2013K1-S 15P X12GL

Tolerierung nach DIN 7167/Tolerance system acc. to DIN 7167.
 (This DIN-standard describes the envelope principle. According to the envelope principle the deviations of form and parallelism are limited by the size tolerances).

ja/yes Stoffverbots- und Deklarationsliste nach UU-TQM-05/03 ist einzuhalten.
 Conformity with Wieland document UU-TQM-05/03 (list of prohibited / declarable hazardous substances) to be declared!

Freitoleranz nach DIN 16901 TG 130
 General tolerance

CAD - Zeichnung, keine manuellen Änderungen
 CAD - drawing, no manual modifications allowed

1. Verwendung:
 First Use:

Blatt: 1 von 1
 Sheet: of 1

/	Werkstoff/Material	2007	Tag/Date	Name	T	Zeichnung Nr./Drawing No.	Index
/		gezeichnet drawn	17.04.	Kneitz			
/	Maßstab/Scale	geprüft checked	-	-			
/	%	Normgepr. Stand. check	-	-	Maße in mm/Dimensions are in mm		
/	Vol.	mm ³ Ofl./Surf.	mm ³	Ersatz für/Replacement for: -			

SONDERLÄNGEN/spezial-length			
Teile-Nr. part-no.	G	L	Farbe color
G0.000.0279.7	14000	13980	schwarz
G0.000.0291.4	15000	14980	schwarz
G0.000.0291.5	18000	17980	schwarz
G0.000.0291.6	12000	11980	schwarz

Index	Datum / Blatt Date / Sheet		Type Benennung/Title KONFEKT_LEITUNG Stecker-freies Ende Crimpausführung/male-free end pre-assembled cable crimp design K1 250V
Änderung/Revision			

962320404001K_4_CADW1019_Kneitz 2007-04-17T08:04:07 1.000