

# IRF7328

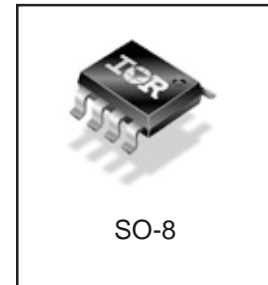
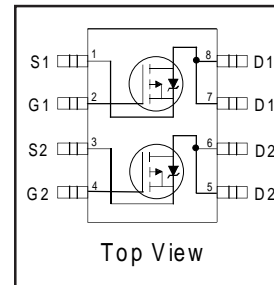
HEXFET<sup>®</sup> Power MOSFET

- Trench Technology
- Ultra Low On-Resistance
- Dual P-Channel MOSFET
- Available in Tape & Reel

$V_{DS}$	$R_{DS(on) \text{ max}}$	$I_D$
<b>-30V</b>	21m $\Omega$ @ $V_{GS} = -10V$	-8.0A
	32m $\Omega$ @ $V_{GS} = -4.5V$	-6.8A

## Description

New trench HEXFET<sup>®</sup> Power MOSFETs from International Rectifier utilize advanced processing techniques to achieve extremely low on-resistance per silicon area. This benefit, combined with the ruggedized device design that HEXFET power MOSFETs are well known for, provides the designer with an extremely efficient and reliable device for use in battery and load management applications.



## Absolute Maximum Ratings

	Parameter	Max.	Units
$V_{DS}$	Drain-Source Voltage	-30	V
$I_D @ T_A = 25^\circ\text{C}$	Continuous Drain Current, $V_{GS} @ -10V$	-8.0	A
$I_D @ T_A = 70^\circ\text{C}$	Continuous Drain Current, $V_{GS} @ -10V$	-6.4	
$I_{DM}$	Pulsed Drain Current <sup>①</sup>	-32	
$P_D @ T_A = 25^\circ\text{C}$	Maximum Power Dissipation <sup>③</sup>	2.0	W
$P_D @ T_A = 70^\circ\text{C}$	Maximum Power Dissipation <sup>③</sup>	1.3	W
	Linear Derating Factor	16	mW/ $^\circ\text{C}$
$V_{GS}$	Gate-to-Source Voltage	$\pm 20$	V
$T_J, T_{STG}$	Junction and Storage Temperature Range	-55 to + 150	$^\circ\text{C}$

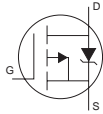
## Thermal Resistance

	Parameter	Max.	Units
$R_{\theta JA}$	Maximum Junction-to-Ambient <sup>③</sup>	62.5	$^\circ\text{C}/\text{W}$

## Electrical Characteristics @ $T_J = 25^\circ\text{C}$ (unless otherwise specified)

	Parameter	Min.	Typ.	Max.	Units	Conditions
$V_{(BR)DSS}$	Drain-to-Source Breakdown Voltage	-30	—	—	V	$V_{GS} = 0V, I_D = -250\mu A$
$\Delta V_{(BR)DSS}/\Delta T_J$	Breakdown Voltage Temp. Coefficient	—	-0.018	—	V/°C	Reference to $25^\circ\text{C}, I_D = -1\text{mA}$
$R_{DS(on)}$	Static Drain-to-Source On-Resistance	—	17	21	m $\Omega$	$V_{GS} = -10V, I_D = -8.0A$ ②
		—	26.8	32		$V_{GS} = -4.5V, I_D = -6.8A$ ②
$V_{GS(th)}$	Gate Threshold Voltage	-1.0	—	-2.5	V	$V_{DS} = V_{GS}, I_D = -250\mu A$
$g_{fs}$	Forward Transconductance	12	—	—	S	$V_{DS} = -10V, I_D = -8.0A$
$I_{DSS}$	Drain-to-Source Leakage Current	—	—	-15	$\mu A$	$V_{DS} = -24V, V_{GS} = 0V$
		—	—	-25		$V_{DS} = -24V, V_{GS} = 0V, T_J = 70^\circ\text{C}$
$I_{GSS}$	Gate-to-Source Forward Leakage	—	—	-100	nA	$V_{GS} = -20V$
	Gate-to-Source Reverse Leakage	—	—	100		$V_{GS} = 20V$
$Q_g$	Total Gate Charge	—	52	78	nC	$I_D = -8.0A$
$Q_{gs}$	Gate-to-Source Charge	—	9.8	—		$V_{DS} = -15V$
$Q_{gd}$	Gate-to-Drain ("Miller") Charge	—	8.3	—		$V_{GS} = -10V$
$t_{d(on)}$	Turn-On Delay Time	—	13	20	ns	$V_{DD} = -15V, V_{GS} = -10.0V$
$t_r$	Rise Time	—	15	23		$I_D = -1.0A$
$t_{d(off)}$	Turn-Off Delay Time	—	198	297		$R_G = 6.0\Omega$
$t_f$	Fall Time	—	98	147		$R_D = 15\Omega$ ②
$C_{iss}$	Input Capacitance	—	2675	—	pF	$V_{GS} = 0V$
$C_{oss}$	Output Capacitance	—	409	—		$V_{DS} = -25V$
$C_{rss}$	Reverse Transfer Capacitance	—	262	—		$f = 1.0\text{MHz}$

## Source-Drain Ratings and Characteristics

	Parameter	Min.	Typ.	Max.	Units	Conditions
$I_S$	Continuous Source Current (Body Diode)	—	—	-2.0	A	MOSFET symbol showing the integral reverse p-n junction diode. 
$I_{SM}$	Pulsed Source Current (Body Diode) ①	—	—	-32		
$V_{SD}$	Diode Forward Voltage	—	—	-1.2	V	$T_J = 25^\circ\text{C}, I_S = -2.0A, V_{GS} = 0V$ ②
$t_{rr}$	Reverse Recovery Time	—	37	56	ns	$T_J = 25^\circ\text{C}, I_F = -2.0A$
$Q_{rr}$	Reverse Recovery Charge	—	36	54	nC	$di/dt = -100A/\mu s$ ②

### Notes:

① Repetitive rating; pulse width limited by max. junction temperature.

② Pulse width  $\leq 400\mu s$ ; duty cycle  $\leq 2\%$ .

③ Surface mounted on FR-4 board,  $t \leq 10\text{sec}$ .

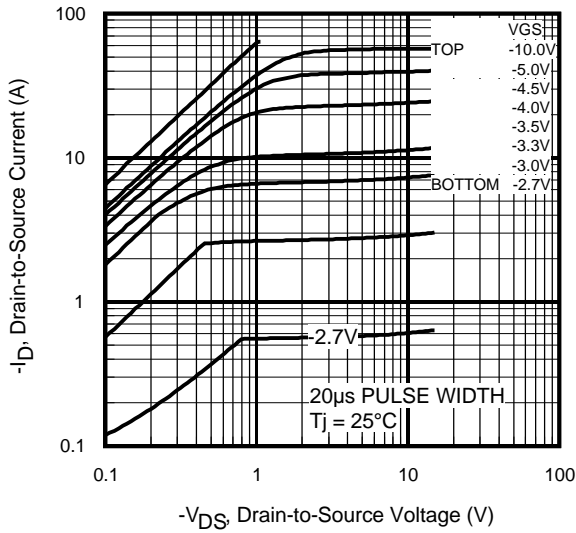


Fig 1. Typical Output Characteristics

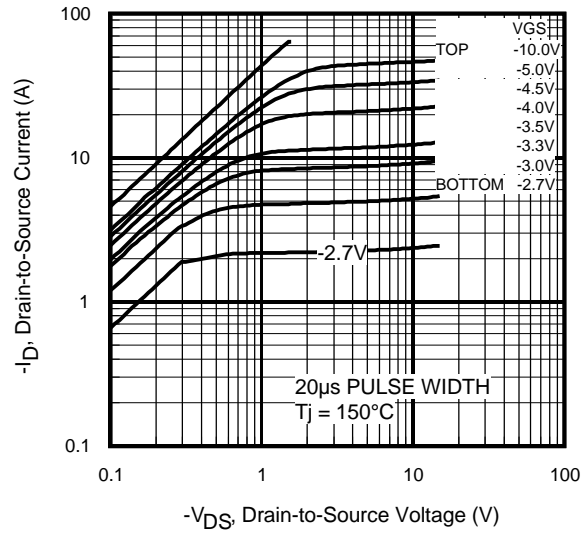


Fig 2. Typical Output Characteristics

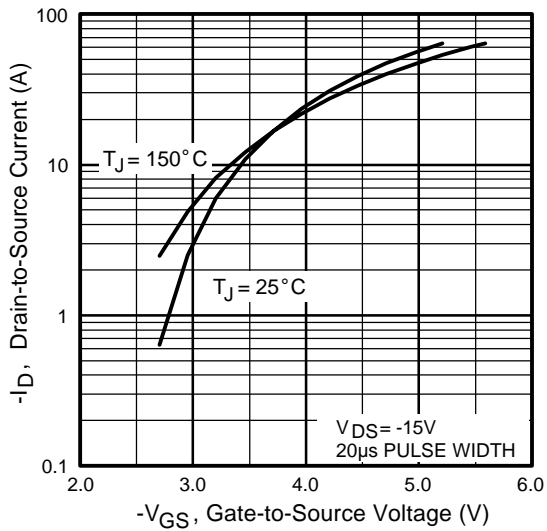


Fig 3. Typical Transfer Characteristics

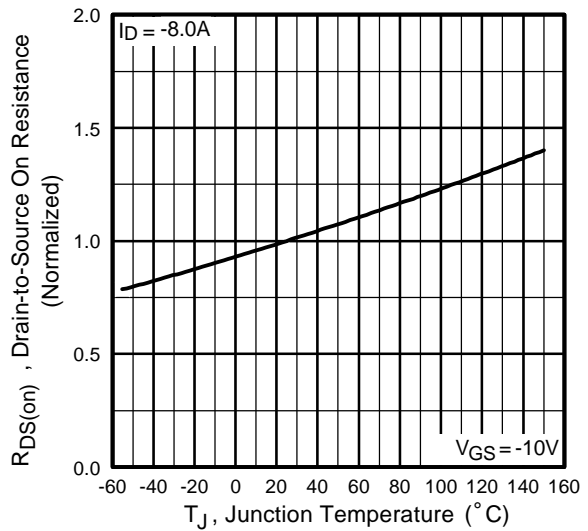
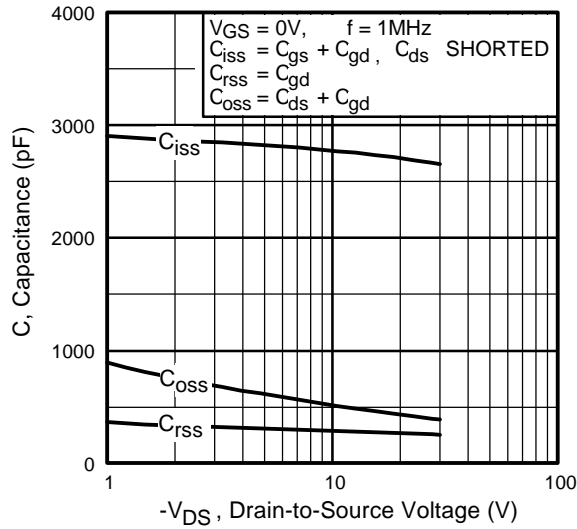
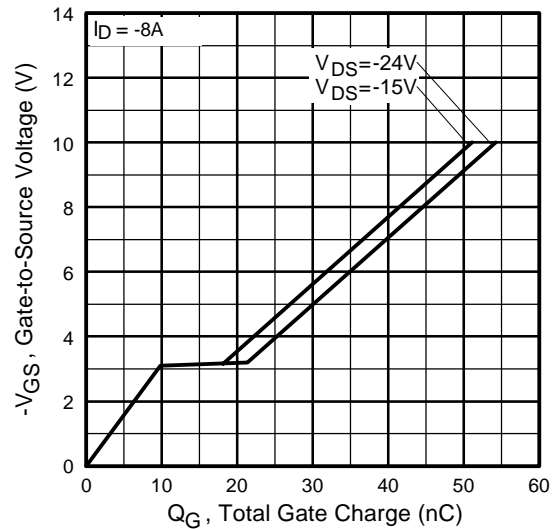


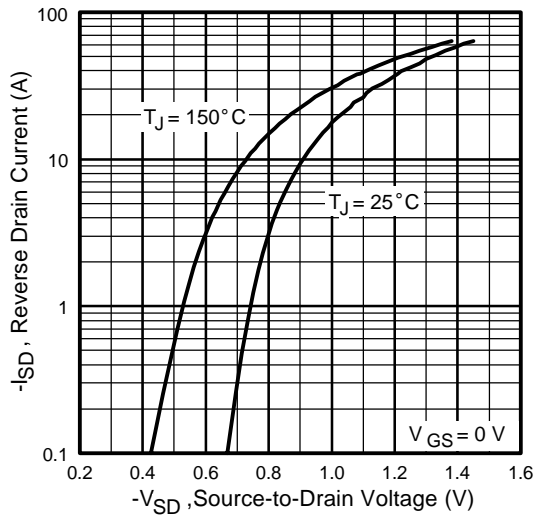
Fig 4. Normalized On-Resistance Vs. Temperature



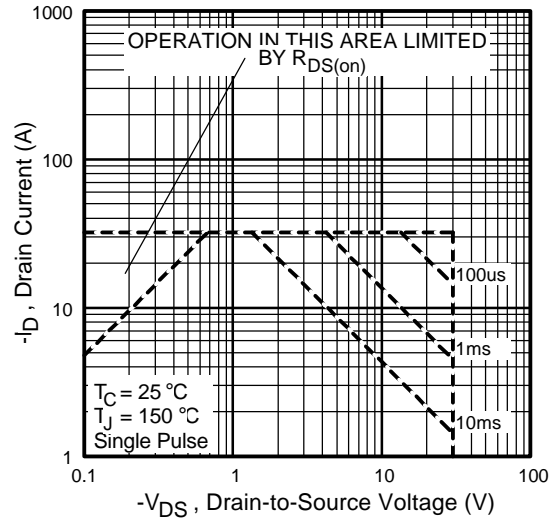
**Fig 5.** Typical Capacitance Vs. Drain-to-Source Voltage



**Fig 6.** Typical Gate Charge Vs. Gate-to-Source Voltage



**Fig 7.** Typical Source-Drain Diode Forward Voltage



**Fig 8.** Maximum Safe Operating Area

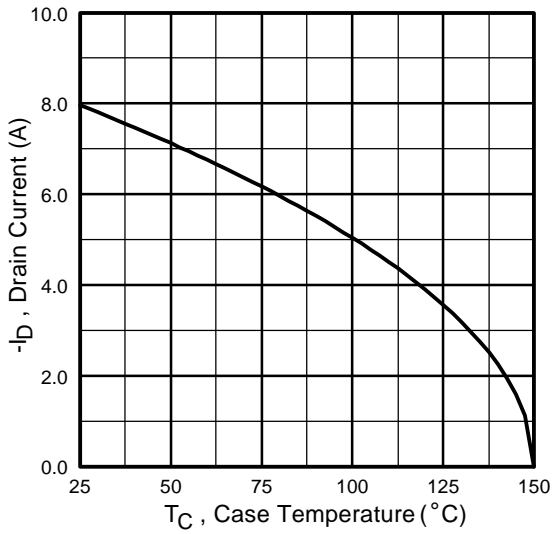


Fig 9. Maximum Drain Current Vs. Case Temperature

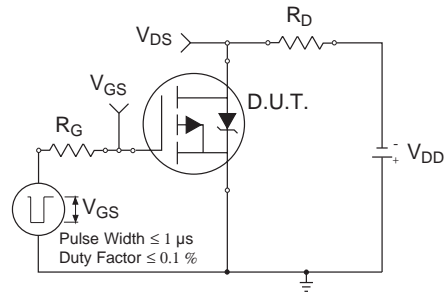


Fig 10a. Switching Time Test Circuit

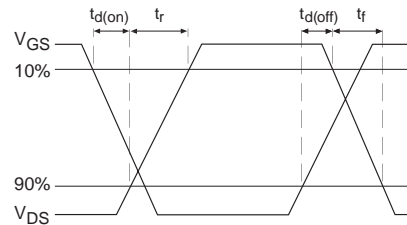


Fig 10b. Switching Time Waveforms

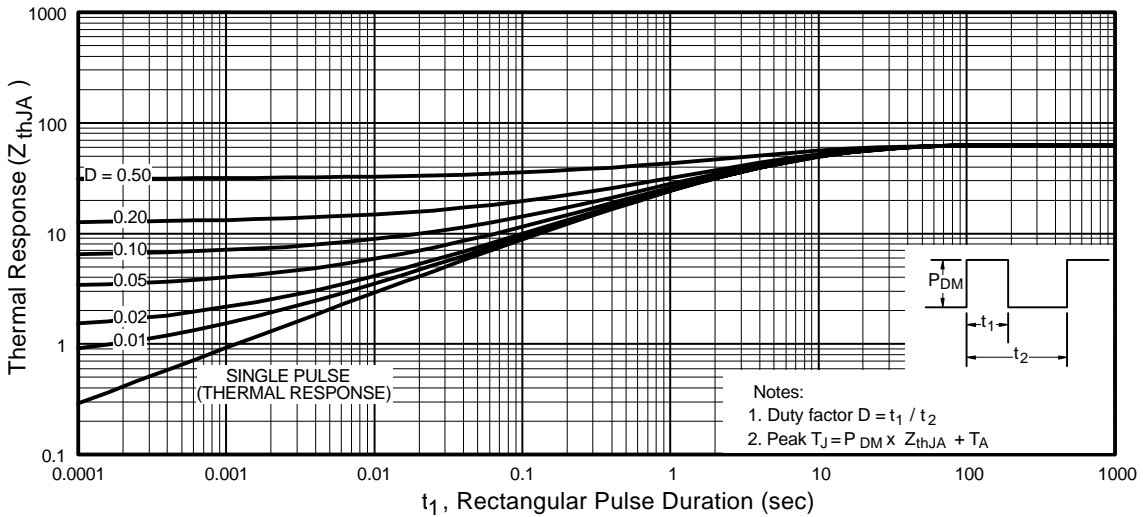
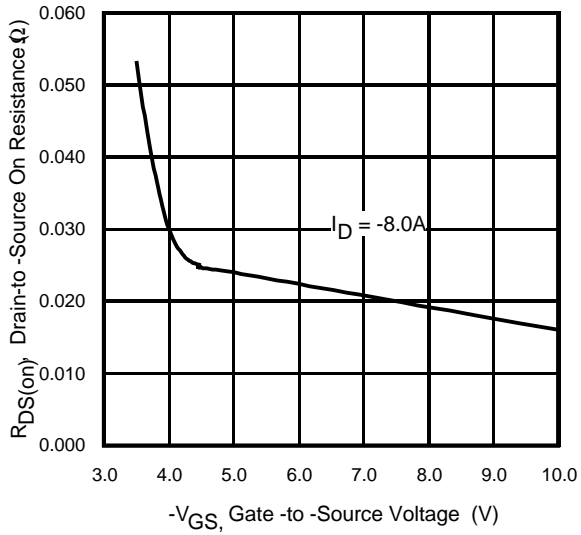
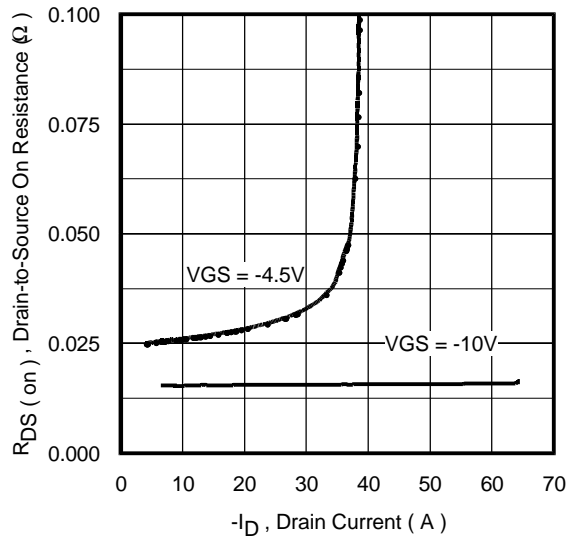


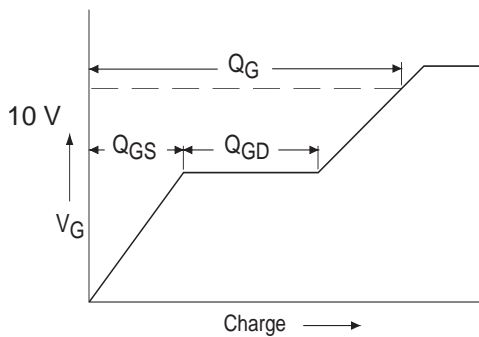
Fig 11. Maximum Effective Transient Thermal Impedance, Junction-to-Ambient



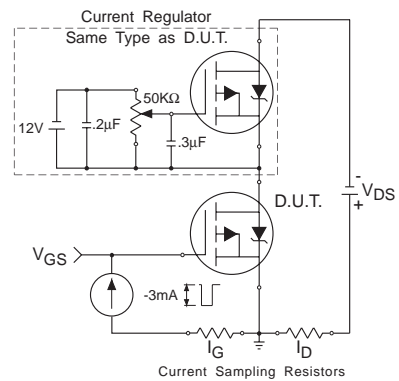
**Fig 12.** Typical On-Resistance Vs. Gate Voltage



**Fig 13.** Typical On-Resistance Vs. Drain Current

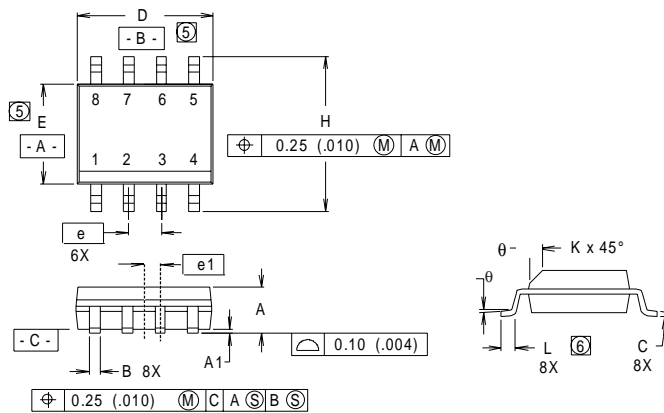


**Fig 14a.** Basic Gate Charge Waveform



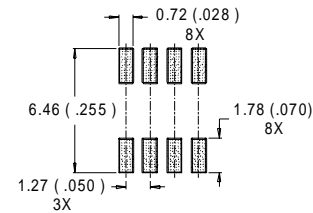
**Fig 14b.** Gate Charge Test Circuit

## SO-8 Package Details



DIM	INCHES		MILLIMETERS	
	MIN	MAX	MIN	MAX
A	.0532	.0688	1.35	1.75
A1	.0040	.0098	0.10	0.25
B	.014	.018	0.36	0.46
C	.0075	.0098	0.19	0.25
D	.189	.196	4.80	4.98
E	.150	.157	3.81	3.99
e	.050 BASIC		1.27 BASIC	
e1	.025 BASIC		0.635 BASIC	
H	.2284	.2440	5.80	6.20
K	.011	.019	0.28	0.48
L	0.16	.050	0.41	1.27
θ	0°	8°	0°	8°

### RECOMMENDED FOOTPRINT

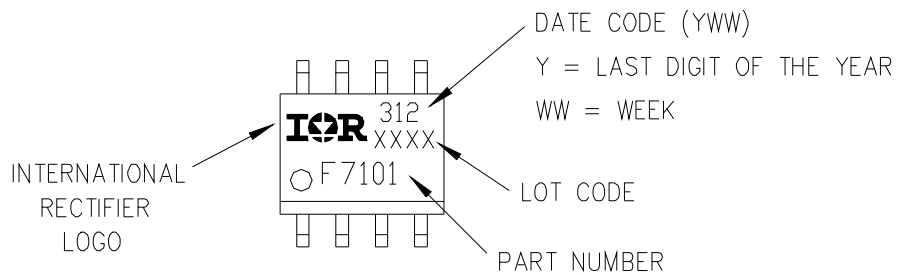


### NOTES:

1. DIMENSIONING AND TOLERANCING PER ANSI Y14.5M-1982.
2. CONTROLLING DIMENSION : INCH.
3. DIMENSIONS ARE SHOWN IN MILLIMETERS (INCHES).
4. OUTLINE CONFORMS TO JEDEC OUTLINE MS-012AA.
5. DIMENSION DOES NOT INCLUDE MOLD PROTRUSIONS  
MOLD PROTRUSIONS NOT TO EXCEED 0.25 (.006).
6. DIMENSIONS IS THE LENGTH OF LEAD FOR SOLDERING TO A SUBSTRATE..

## Part Marking

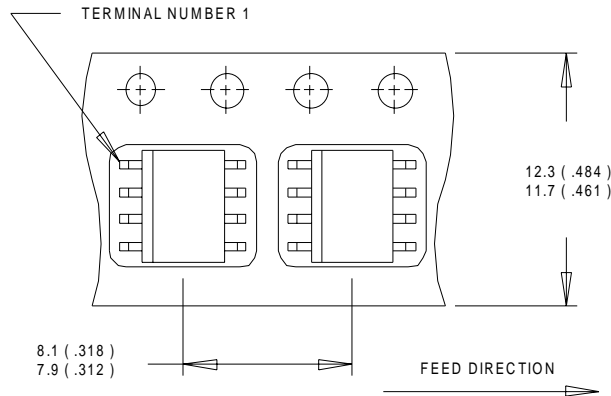
EXAMPLE: THIS IS AN IRF7101



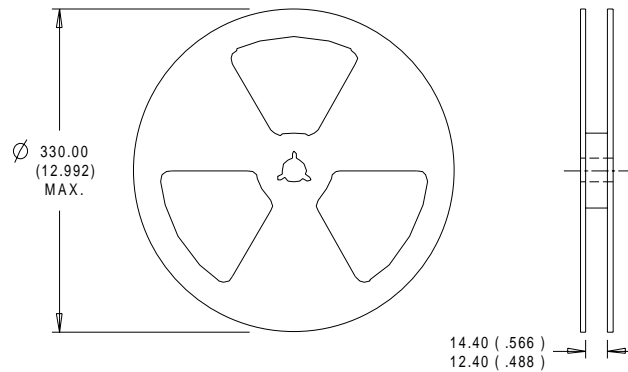
# IRF7328

International  
**IR** Rectifier

## Tape and Reel



- NOTES:
1. CONTROLLING DIMENSION : MILLIMETER.
  2. ALL DIMENSIONS ARE SHOWN IN MILLIMETERS(INCHES).
  3. OUTLINE CONFORMS TO EIA-481 & EIA-541.



- NOTES :
1. CONTROLLING DIMENSION : MILLIMETER.
  2. OUTLINE CONFORMS TO EIA-481 & EIA-541.

International  
**IR** Rectifier

**IR WORLD HEADQUARTERS:** 233 Kansas St., El Segundo, California 90245, USA Tel: (310) 252-7105  
**IR EUROPEAN REGIONAL CENTRE:** 439/445 Godstone Rd, Whyteleafe, Surrey CR3 OBL, UK Tel: ++ 44 (0)20 8645 8000  
**IR CANADA:** 15 Lincoln Court, Brampton, Ontario L6T3Z2, Tel: (905) 453 2200  
**IR GERMANY:** Saalburgstrasse 157, 61350 Bad Homburg Tel: ++ 49 (0) 6172 96590  
**IR ITALY:** Via Liguria 49, 10071 Borgaro, Torino Tel: ++ 39 011 451 0111  
**IR JAPAN:** K&H Bldg., 2F, 30-4 Nishi-Ikebukuro 3-Chome, Toshima-Ku, Tokyo 171 Tel: 81 (0)3 3983 0086  
**IR SOUTHEAST ASIA:** 1 Kim Seng Promenade, Great World City West Tower, 13-11, Singapore 237994 Tel: ++ 65 (0)838 4630  
**IR TAIWAN:** 16 Fl. Suite D. 207, Sec. 2, Tun Haw South Road, Taipei, 10673 Tel: 886-(0)2 2377 9936

*Data and specifications subject to change without notice. 10/00*