

DC/DC Converter

K78xx-500R3-LB Series

MORNSUN®

Wide input voltage non-isolated and regulated single output



Report EN 62368-1
 Report BS EN 62368-1
 RoHS
 Patent Protection

FEATURES

- Economical open frame power supply
- High efficiency up to 95%
- Operating ambient temperature range: -40°C to +85°C
- No-load input current as low as 0.2mA
- Support the negative output
- Output short-circuit protection

K78xx-500R3-LB series are high efficiency switching regulators. The converters feature high efficiency, low loss, short circuit protection, positive or negative output voltage, and there is no need for a heat sink. These products are widely used in applications such as industrial control, instrumentation and electric power.

Selection Guide

Certification	Part No.	Input Voltage (VDC)*	Output		Full Load Efficiency (%) Typ. Vin Min. / Vin Max.	Capacitive Load (μF) Max.
		Nominal (Range)	Voltage (VDC)	Current (mA)		
EN/BS EN	K7803-500R3-LB	24 (4.75-36)	3.3	500	85/76	680
		12 (7-32)	-3.3	-300	73/72	330
	K7805-500R3-LB	24 (6.5-36)	5	500	90/81	680
		12 (7-31)	-5	-300	76/78	330
	K78X6-500R3-LB	24 (8-36)	6.5	500	91/83	680
		12 (7-29)	-6.5	-300	76/77	330
	K7809-500R3-LB	24 (12-36)	9	500	93/87	680
		12 (8-27)	-9	-150	83/77	330
	K7812-500R3-LB	24 (15-36)	12	500	94/88	680
		12 (8-24)	-12	-150	85/82	330
	K7815-500R3-LB	24 (19-36)	15	500	95/90	680
		12 (8-21)	-15	-150	80/79	330

Note: * For input voltages exceeding 30 VDC, an input capacitor of 22μF/50V is required.

Input Specifications

Item	Operating Conditions		Min.	Typ.	Max.	Unit
No-load Input Current	Nominal input voltage	Positive output	--	0.2	1.5	mA
		Negative output	--	1	10	
Reverse Polarity at Input			Avoid / Not protected			
Input Filter			Capacitance filter			

Output Specifications

Item	Operating Conditions		Min.	Typ.	Max.	Unit
Voltage Accuracy	Full load, input voltage range	K7803-500R3-LB	--	±2	±4	%

MORNSUN®

MORNSUN Guangzhou Science & Technology Co., Ltd.

2022.02.15-A/3 Page 1 of 4

MORNSUN Guangzhou Science & Technology Co., Ltd. reserves the copyright and right of final interpretation

Voltage Accuracy	Full load, input voltage range	Others	--	±2	±3	%
Linear Regulation	Full load, input voltage range		--	±0.2	±0.5	
Load Regulation	Nominal input voltage, 0% -100% load		--	±0.3	±1	
Ripple & Noise*	20MHz bandwidth, nominal input voltage, 20% -100% load		--	50	100	mVp-p
Temperature Coefficient	Operating ambient temperature -40°C to +85°C		--	±0.02	--	%/°C
Transient Response Deviation	Nominal input voltage, 25% load step change		--	±50	±250	mV
Transient Recovery Time			--	0.2	1	ms
Short-circuit Protection	Nominal input voltage		Continuous, self-recovery			

Notes: * 1.The "parallel cable" method is used for ripple and noise test, please refer to DC-DC Converter Application Notes for specific information;
2.With light loads at or below 20%, Ripple & Noise increases to 300mVp-p max.,

General Specifications

Item	Operating Conditions	Min.	Typ.	Max.	Unit
Operating Temperature	See Fig. 1	-40	--	+85	°C
Storage Temperature		-55	--	+125	
Pin Soldering Resistance Temperature	Soldering time: 10 seconds	--	--	+260	
Storage Humidity	Non-condensing	5	--	95	%RH
Switching Frequency	Full load, nominal input voltage	--	700	--	kHz
MTBF	MIL-HDBK-217F@25°C	2000	--	--	k hours

Mechanical Specifications

Dimensions	10.27 x 6.00 x 8.61 mm
Weight	0.6g (Typ.)
Cooling Method	Free air convection

Electromagnetic Compatibility (EMC)

Emissions	CE	CISPR32/EN55032	CLASS B (see Fig. 5-② for recommended circuit)	
	RE	CISPR32/EN55032	CLASS B (see Fig. 5-② for recommended circuit)	
Immunity	ESD	IEC/EN 61000-4-2	Contact ±4kV	perf. Criteria B
	RS	IEC/EN 61000-4-3	10V/m	perf. Criteria A
	EFT	IEC/EN 61000-4-4	±1kV (see Fig. 5-① for recommended circuit)	perf. Criteria B
	Surge	IEC/EN 61000-4-5	line to line ±1kV (see Fig. 5-① for recommended circuit)	perf. Criteria B
	CS	IEC/EN 61000-4-6	3Vr.m.s	perf. Criteria A

Typical Characteristic Curves

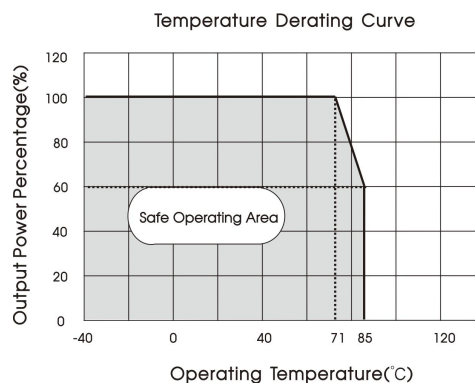
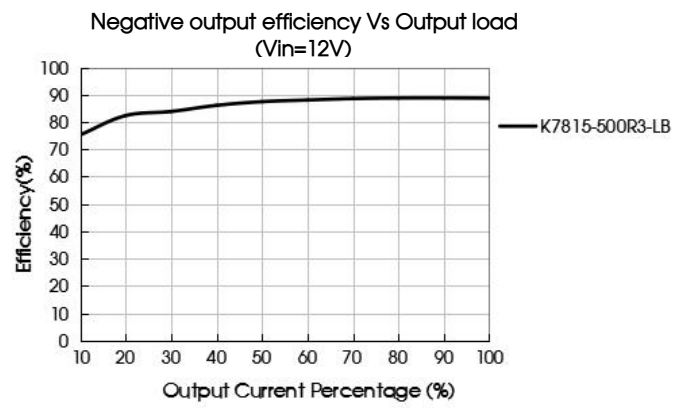
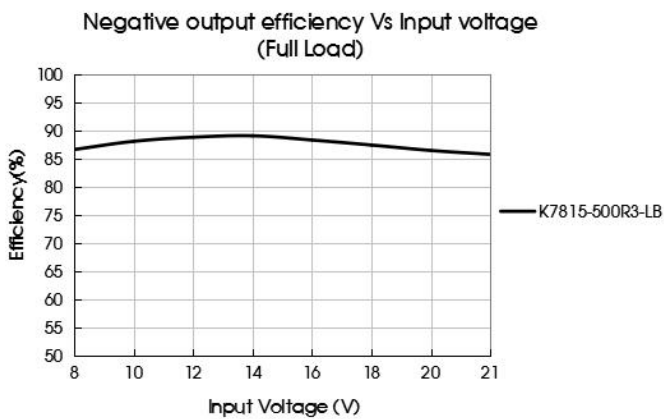
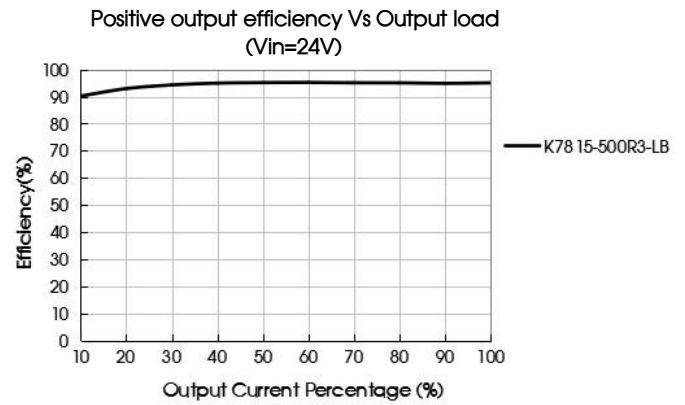
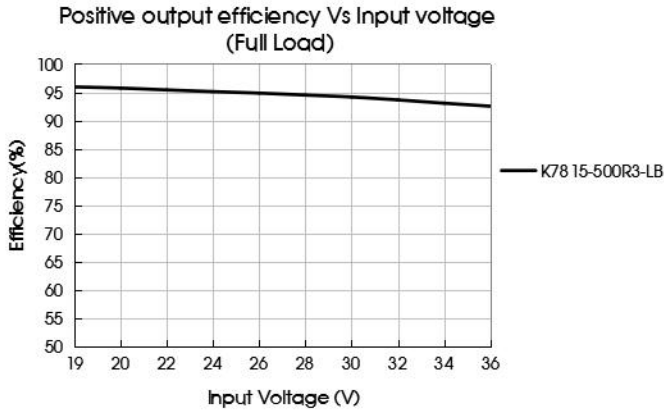

Fig. 1



Design Reference

1. Typical application

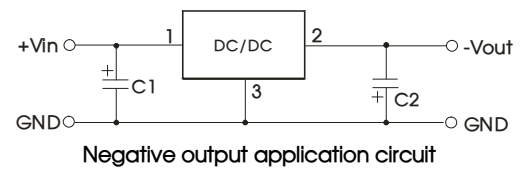
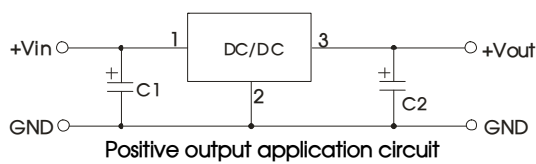

Fig. 2 Typical application circuit

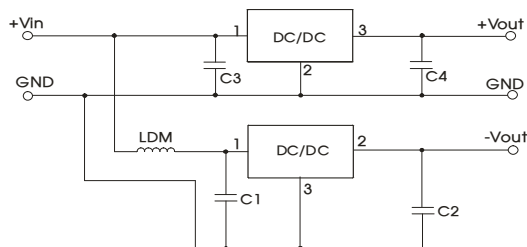

Fig. 3 Positive and negative output application circuit

Table 1

Part No.	C1/C3 (ceramic capacitor)	C2/C4 (ceramic capacitor)
K7803-500R3-LB	10μF/50V	22μF/10V
K7805-500R3-LB		22μF/10V
K78X6-500R3-LB		22μF/16V
K7809-500R3-LB		22μF/16V
K7812-500R3-LB		22μF/25V
K7815-500R3-LB		22μF/25V

Notes:

1. The required capacitors C1 and C2 (C3 and C4) must be connected as close as possible to the terminals of the module;
2. Refer to Table 1 for C1 and C2 (C3 and C4) capacitor values. For certain applications, increased values and/or tantalum or low ESR electrolytic capacitors may also be used instead;
3. When using configurations as shown in figure 3, we recommended to add an inductor (LDM) with a value of up to 10μH which helps reducing mutual interference;
4. Converter cannot be used for hot swap and with output in parallel;
5. To further reduce the output ripple and noise, we suggested the use of a "LC" filter at the output terminals, with an inductor value (L) of 10μH-47μH.

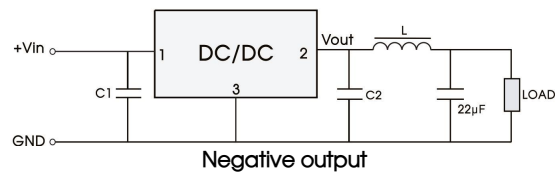
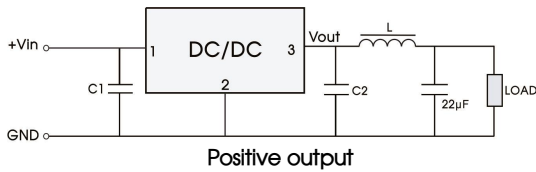

Fig. 4 "LC" output filter application

2. EMC compliance circuit

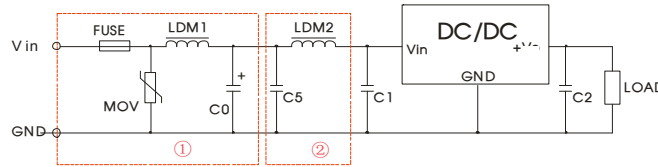

Fig. 5 EMC compliance circuit

FUSE	MOV	LDM1	C0	C1/C2	C5	LDM2
Select fuse value according to actual input current	S20K30	82µH	680µF /50V	Refer to table 1	10µF /50V	22µH

Notes: For EMC tests we use Part ① in Fig. 5 for immunity and part ② for emissions test. Selecting based on needs.

3. For additional information please refer to DC-DC converter application notes on www.mornsun-power.com

Dimensions and Recommended Layout

THIRD ANGLE PROJECTION

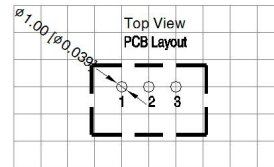
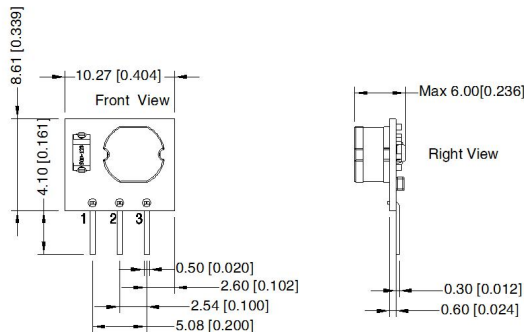

Pin-Out		
Pin	Positive Output	Negative Output
1	Vin	Vin
2	GND	-Vout
3	Vout	GND

Note:
Unit: mm[inch]
Pin section tolerances: ±0.20 [±0.008]
General tolerances: ±0.50 [±0.020]
The layout of the device is for reference only, please refer to the actual product

Notes:

- For additional information on Product Packaging please refer to www.mornsun-power.com. Packaging bag number: 58210141;
- The maximum capacitive load offered were tested at nominal input voltage and full load;
- Unless otherwise specified, parameters in this datasheet were measured under the conditions of Ta=25°C, humidity<75%RH with nominal input voltage and rated output load;
- All index testing methods in this datatable are based on our company corporate standards;
- We can provide product customization service, please contact our technicians directly for specific information;
- Products are related to laws and regulations: see "Features" and "EMC";
- Our products shall be classified according to ISO14001 and related environmental laws and regulations, and shall be handled by qualified units.

MORNSUN Guangzhou Science & Technology Co., Ltd.

Address: No. 5, Kehui St. 1, Kehui Development Center, Science Ave., Guangzhou Science City, Huangpu District, Guangzhou, P. R. China
Tel: 86-20-38601850 Fax: 86-20-38601272 E-mail: info@mornsun.cn www.mornsun-power.com