

Outline:

- 5.8 x 5.2mm Typ.(L x W),3.5mm Typ.Height
- Carrier tape packing, suitable for SMT process
- Low DCR and excellent current handling
- Magnetically shielded construction
- In addition to the standard versions of inductors shown here custom inductors are available to meet your exact requirements

Features:

- Core material:Ferrite
- Core and winding loss:
See www.codaca.com/en/PowerInductorLossComparison
- Environmental: RoHS, Reach compliant ,Halogen free
- Weight:0.38g
- Moisture Sensitivity:Level (MSL) 1
(unlimited floor life at <30°C / 85% relative humidity).
- Operating temperature range: -40°C~+125°C
(including coil's self temperature rise)
- Storage temperature range: -40°C~+125°C

Application:

- Ideally used in Notebook PC,LCD T,Game machine STB
- buck converter,network communication equipment, and etc

1 Electrical Characteristics

Part No.	Inductance (μH)※1	D.C.R. (m Ω)		Isat	Irms
		Typical	Max	(A)※2	(A) ※3
SP53-1R2M	1.20 \pm 20%	11.0	13.1	5.13	5.40
SP53-2R2M	2.20 \pm 20%	15.4	18.5	3.30	3.95
SP53-3R3M	3.30 \pm 20%	19.8	23.8	2.60	3.45
SP53-4R7M	4.70 \pm 20%	29.9	35.9	2.20	2.82
SP53-6R8M	6.80 \pm 20%	41.0	49.2	1.92	2.34
SP53-100K	10.0 \pm 10%	55.0	66.0	1.70	2.20
SP53-120K	12.0 \pm 10%	72.7	87.2	1.60	1.95
SP53-150K	15.0 \pm 10%	80.4	96	1.38	1.85
SP53-180K	18.0 \pm 10%	96	116	1.30	1.51
SP53-220K	22.0 \pm 10%	128	154	1.20	1.46
SP53-270K	27.0 \pm 10%	158	190	1.08	1.25
SP53-330K	33.0 \pm 10%	175	210	0.95	1.18
SP53-390K	39.0 \pm 10%	210	252	0.88	1.11
SP53-470K	47.0 \pm 10%	240	288	0.82	0.95
SP53-560K	56.0 \pm 10%	294	353	0.74	0.91
SP53-680K	68.0 \pm 10%	372	446	0.68	0.81
SP53-820K	82.0 \pm 10%	464	557	0.63	0.72
SP53-101K	100 \pm 10%	550	660	0.56	0.67
SP53-121K	120 \pm 10%	629	755	0.54	0.56
SP53-151K	150 \pm 10%	760	911	0.47	0.54
SP53-181K	180 \pm 10%	956	1,147	0.43	0.50
SP53-221K	220 \pm 10%	1,375	1,650	0.39	0.45
SP53-271K	270 \pm 10%	1,570	1,884	0.36	0.40
SP53-331K	330 \pm 10%	1,832	2,198	0.31	0.37
SP53-391K	390 \pm 10%	2,250	2,700	0.30	0.32
SP53-471K	470 \pm 10%	2,670	3,204	0.26	0.30
SP53-561K	560 \pm 10%	3,060	3,672	0.24	0.28
SP53-681K	680 \pm 10%	3,900	4,680	0.21	0.24
SP53-821K	820 \pm 10%	4,770	5,724	0.20	0.23
SP53-102K	1,000 \pm 10%	5,660	6,792	0.19	0.20

2 Product Dimensions (mm)

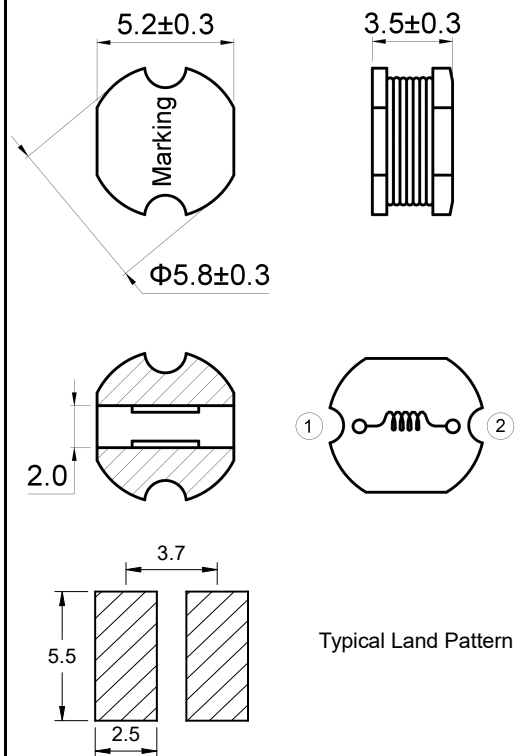

All data is tested on 25°C ambient temperature

1. Inductance measure condition at 1.00kHz,0.25V
2. Isat:the actual value of DC current when the Inductance decrease 20% of its initial value
3. Irms:the actual value of DC current when the the temperature rise is $\Delta T40^\circ\text{C}$ ($T_a=25^\circ\text{C}$)

3 Saturation Current vs Temperature Rise Current Curve

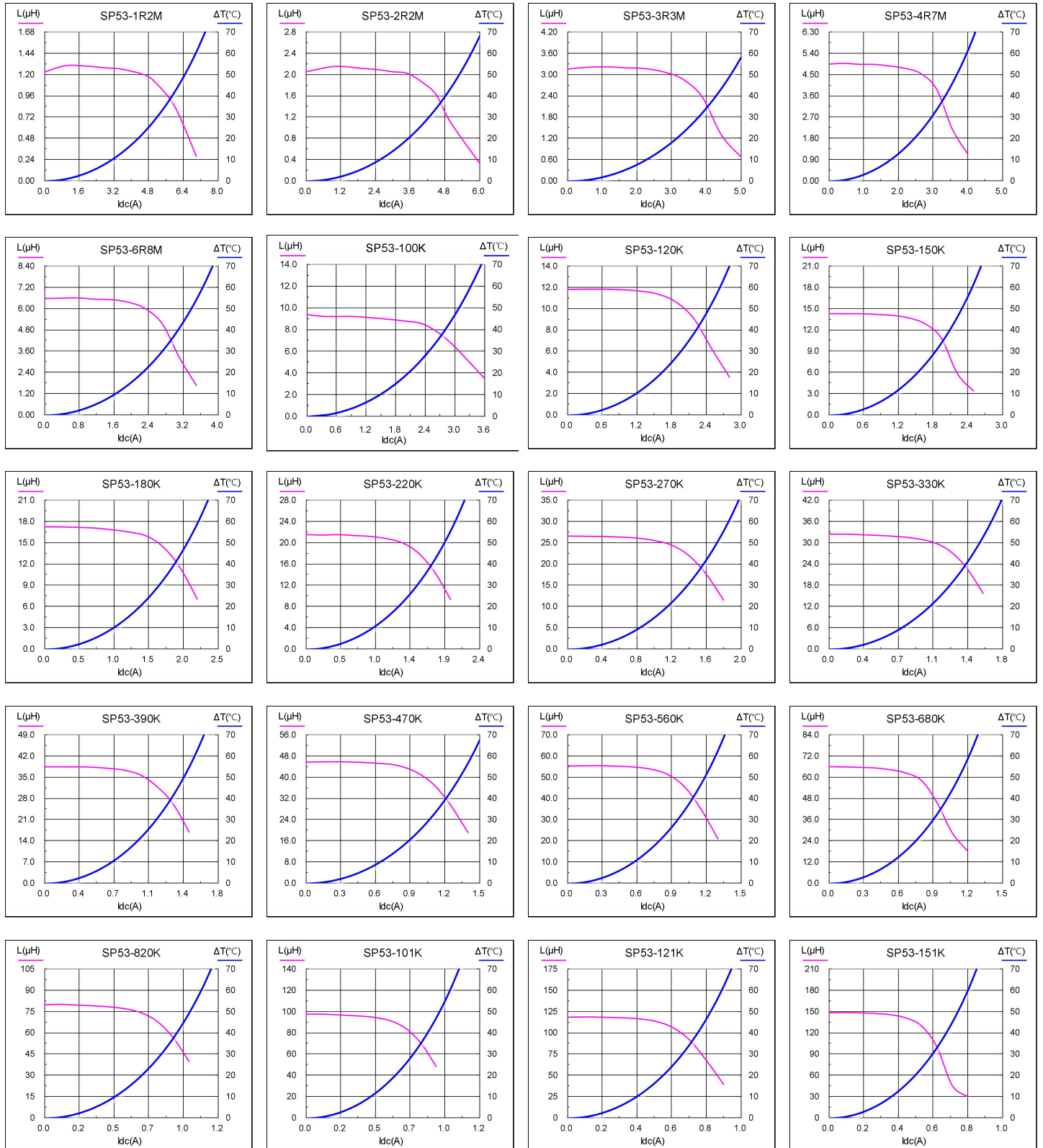

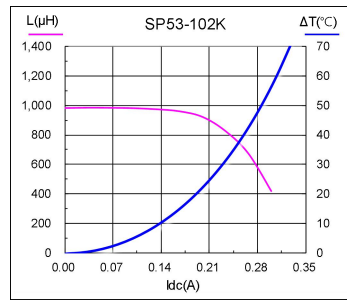
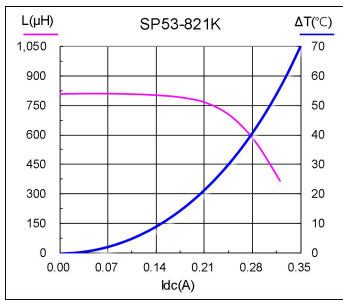
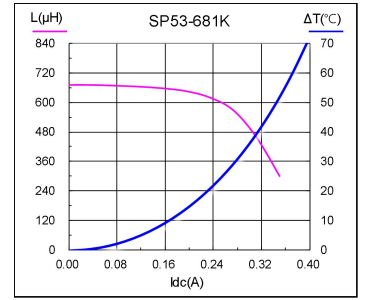
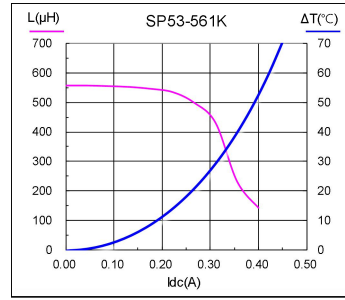
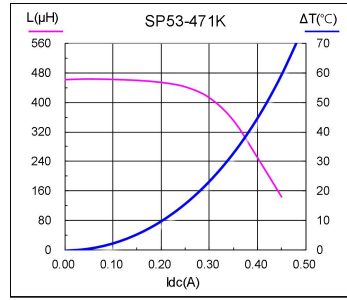
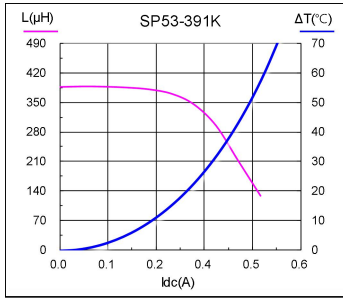
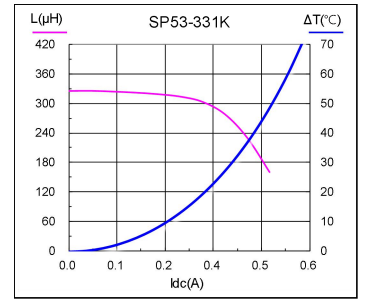
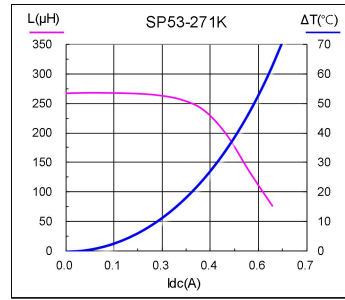
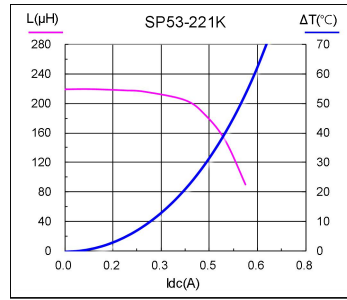
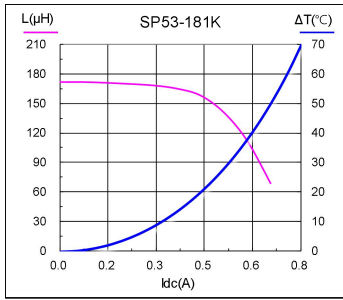

4 Packing Specification

4.1 Carrier Tape Dimensions (mm)

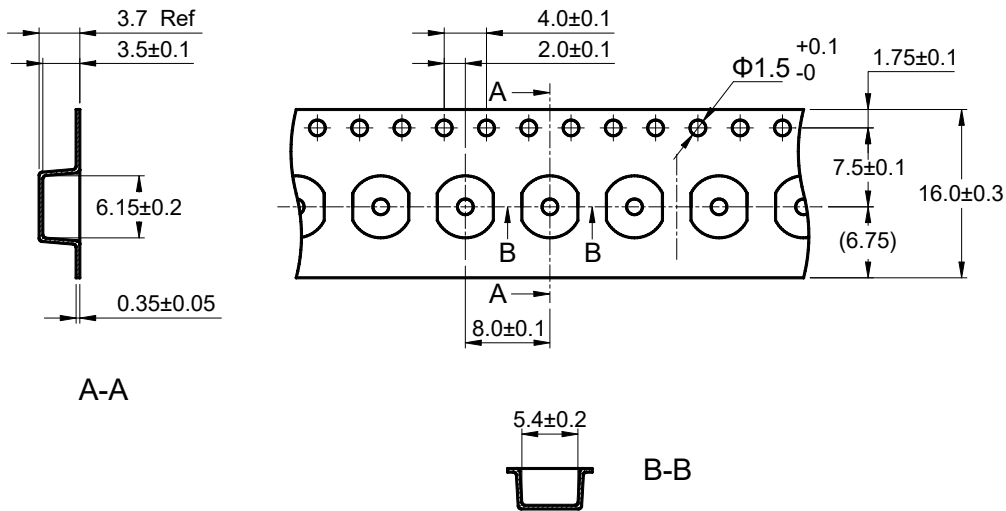

※ Packing is referred to the international standard IEC 60286-3.

4.2 Reel Dimensions (mm)

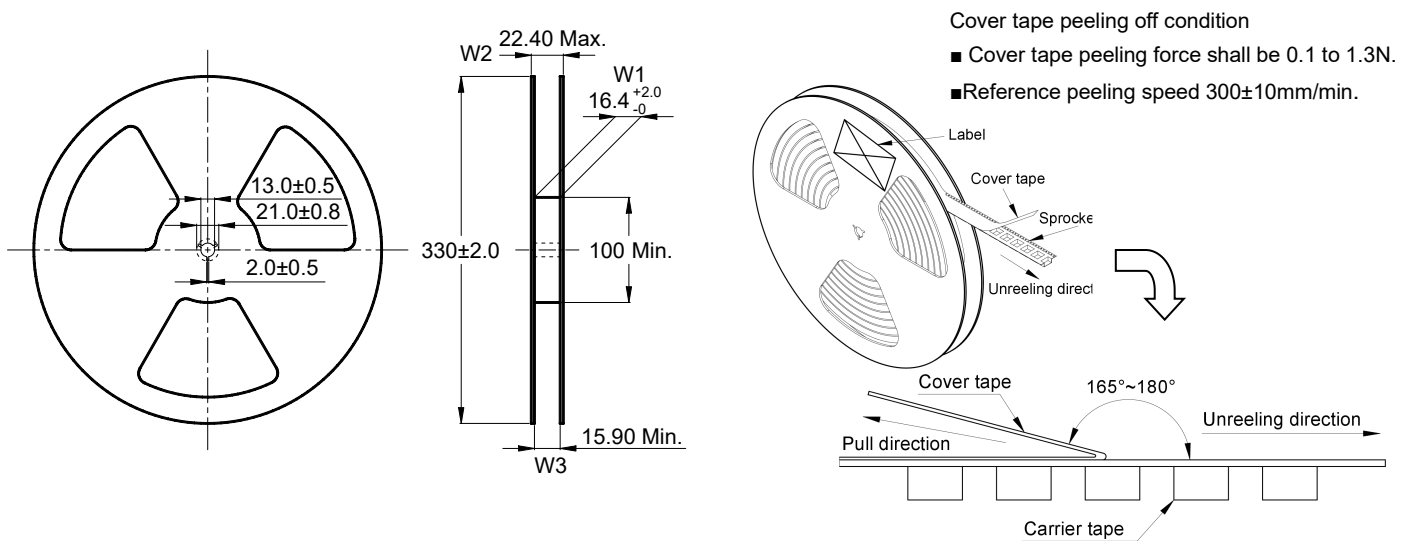

4.3 Carton Dimensions and Packing Quantity

■ Inner Carton: 365×345×105mm ■ Out Carton : 385×365×235mm

Product Series	Quantity / Reel	Inner Carton Quantity	Out Carton Quantity
SP43	2000pcs	(2000×4) = 8000pcs	(8000×2) = 16000pcs

5 Soldering Specification

5.1 Reflow Profile for SMT Components

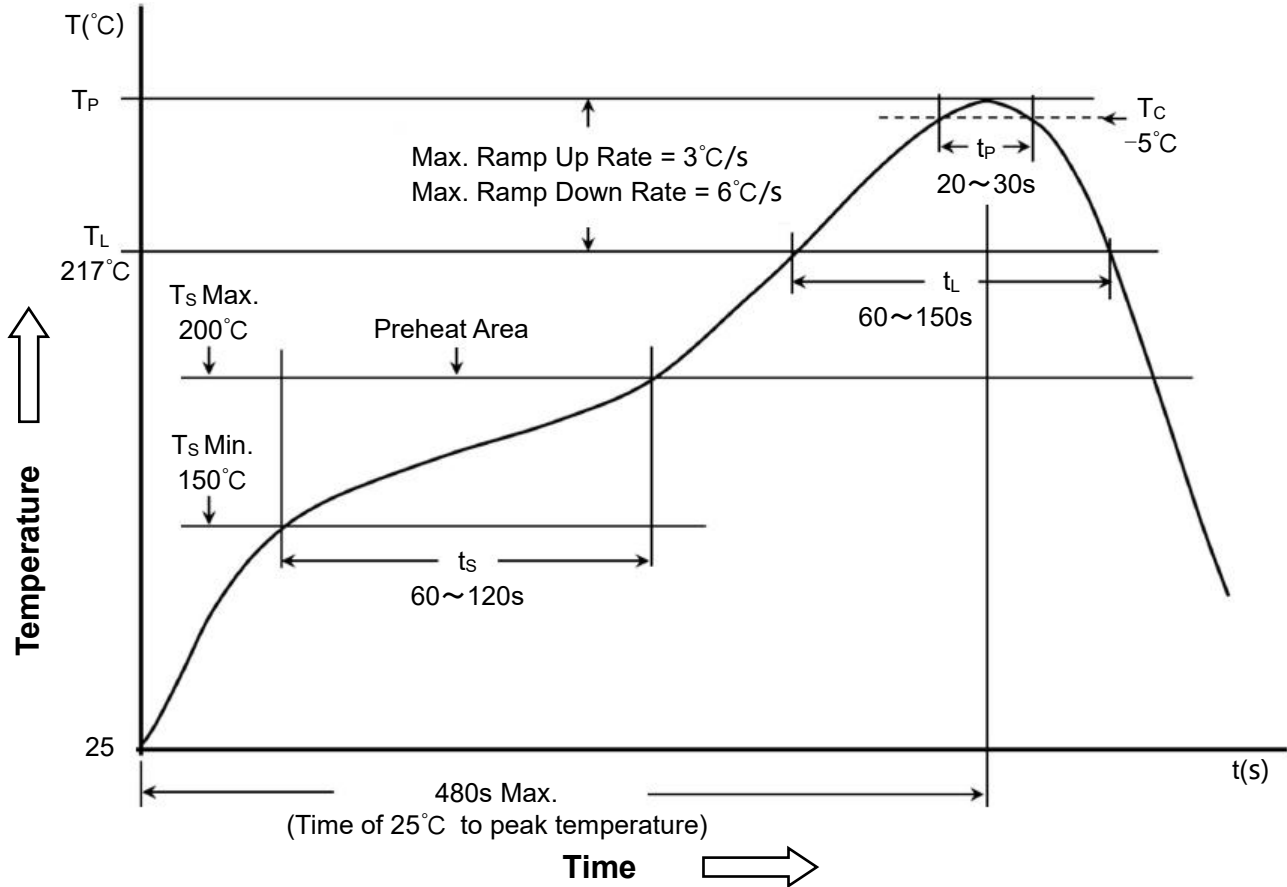

5.2 Classification of Peak Package Body Temperature (Tp)

	Package Thickness	Package Volume		
		<350 mm ³	350~2000 mm ³	>2000 mm ³
PB-Free Assembly	<1.6mm	260°C	260°C	260°C
	1.6~2.5mm	260°C	250°C	245°C
	≥2.5mm	250°C	245°C	245°C

※ Reflow is referred to standard IPC/JEDEC J-STD-020D.

6 Notice of Use

- 6.1 Special remind:Circuit design, component placement, PCB size and thickness, cooling system and etc. all will affect the product temperature. Please verify the product temperature in the final application.
- 6.2 Product in packing storage condition:temperature 5~40°C, RH≤70%.
If taking out for use, the remaining products should be sealed in plastic bags and preserved in accordance with the above conditions, to avoid oxidation of terminals (electrodes), affecting soldering status.
- 6.3 A storage of Codaca Electronic products for longer than 12 months is not recommended, Within other effects, the terminals may suffer degradation, resulting in bad solderability. Therefore, all products shall be used within the period of 12 months based on the day of shipment.
- 6.4 Do not keep products in unsuitable storage conditions, such as areas susceptible to high temperatures, high humidity, dust or corrosion.
- 6.5 Always handle products with care.
- 6.6 Don't touch electrodes directly with bare hands as oil secretions may inhibit soldering.
Always ensure optimum conditions for soldering.
- 6.7 When this product will be used on a similar or new project to the original one, sometimes it might be unable to satisfy the specifications due to different condition of usage.
- 6.8 This inductor itself does not have any protective function in abnormal condition, such as overload, short-circuit, open-circuit conditions, etc. Therefore, it shall be confirmed that there is no risk of smoke, fire, dielectric withstand voltage, insulation resistance, etc., or use in abnormal conditions protective devices or protection circuit in the end product.
- 6.9 Hi-Pot test with higher voltage than spec value will damage insulating material and shorten its life.
- 6.10 If using in potting compound, the magnet wire coating might be damaged, please consult with us.
- 6.11 Refrain from rinsing coils. If necessary, please consult with us.