



Film Capacitors

Metallized Polyester Film Capacitors (MKT)

Series/Type: B32591 ... B32594

Date: May 2009

General purpose (stacked/wound)
Typical applications

- Compact fluorescent lamps (CFL)
- Blocking
- Coupling, decoupling
- Bypassing

Climatic

- Max. operating temperature: 125 °C
- Climatic category (IEC 60068-1): 55/100/56

Features

- High pulse strength
- High contact reliability

Construction

- Dielectric: polyethylene terephthalate (polyester, PET)
- Stacked-film technology for lead spacing 10 and 15 mm (100 ... 400 V DC); Wound capacitor technology for lead spacing 10 and 15 mm (630 V DC) as well as for lead spacing 22.5 and 27.5 mm
- Epoxy resin coating (UL 94 V-0)

Terminals

- Crimped wire leads, lead-free tinned, lead length 6 – 1 mm or min. 20 mm
- Straight wire leads, lead-free tinned, lead length 17 ± 3 mm
- Different lead spacings (reduced and enlarged) available, lead length 6 – 1 mm

Marking

Manufacturer's logo,
 rated capacitance (coded),
 capacitance tolerance (code letter),
 rated DC voltage,
 additional for lead spacing ≥ 15 mm:
 style, type, date of manufacture (coded)

Delivery mode

Bulk (untaped)
 Taped (Ammo pack or reel) for lead spacing ≤ 22.5 mm.
 For notes on taping, refer to chapter "Taping and packing".

Dimensional drawing

Crimped leads

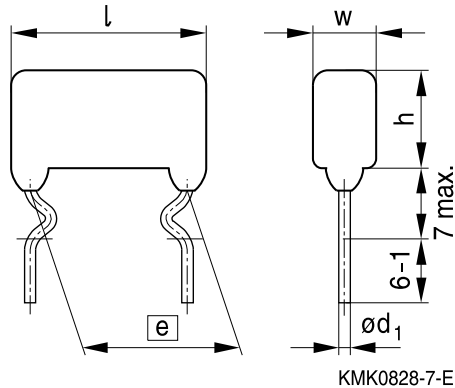

Straight leads

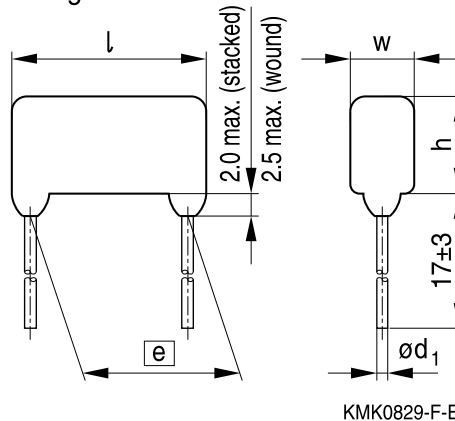

Dimensions in mm

Lead spacing $e \pm 0.8$	Lead diameter d_1	Type
10.0	0.6 ¹⁾	B32591
15.0	0.6	B32592
22.5	0.8	B32593
27.5	0.8	B32594



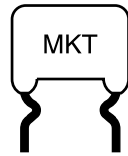

 1) 0.5 mm for capacitor width $w \leq 5$ mm



Overview of available types

Lead spacing	10.0 mm				15.0 mm				22.5 mm			
Type	B32591				B32592				B32593			
Page	5				6				7			
Technology	s	s	s	w	s	s	s	w	w	w	w	w
V_R (V DC)	100	250	400	630	100	250	400	630	100	250	400	630
V_{RMS} (V AC)	63	160	200	200	63	160	200	200	63	160	200	200
C_R (μ F)												
0.010												
0.015												
0.022												
0.033												
0.047												
0.068												
0.10												
0.15												
0.22												
0.33												
0.47												
0.68												
1.0												
1.5												
2.2												
3.3												
4.7												
6.8												

Technology: s = Stacked-film technology / w = Wound capacitor technology

Lead configurations

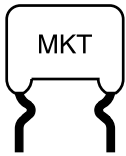
Series	Standard	Reduced	Enlarged	Straight
				
B32591	10 mm	5 / 7.5 mm	–	10 mm
B32592	15 mm	7.5 / 10 / 12.5 mm	17.5 mm	15 mm
B32593	22.5 mm	17.5 / 20 mm	25 mm	22.5 mm
B32594	27.5 mm	25 mm	–	27.5 mm



B32591 ... B32594





General purpose (stacked/wound)

Overview of available types

Lead spacing	27.5 mm			
Type	B32594			
Page	8			
Technology	w	w	w	w
V_R (V DC)	100	250	400	630
V_{RMS} (V AC)	63	160	200	220
C_R (μ F)				
0.33				
0.47				
0.68				
1.0				
1.5				
2.2				
3.3				
4.7				
6.8				
10				

Technology: s = Stacked-film technology / w = Wound capacitor technology

Lead configurations

Series	Standard	Reduced	Enlarged	Straight
				
B32591	10 mm	5 / 7.5 mm	–	10 mm
B32592	15 mm	7.5 / 10 / 12.5 mm	17.5 mm	15 mm
B32593	22.5 mm	17.5 / 20 mm	25 mm	22.5 mm
B32594	27.5 mm	25 mm	–	27.5 mm

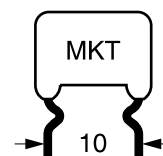
Ordering codes and packing units (lead spacing 10 mm)

V_R	V_{RMS} $f \leq 60$ Hz	C_R	Max. dimensions $w \times h \times l$ mm	Ordering code (composition see below)	Ammo pack pcs./MOQ	Reel pcs./ MOQ	Untaped pcs./ MOQ
V DC	V AC	μF					
100	63	0.10	$5.0 \times 9.0 \times 13.0$	B32591C1104+***	3600	6000	6000
		0.15	$5.0 \times 9.0 \times 13.0$	B32591C1154+***	3600	6000	6000
		0.22	$5.0 \times 9.0 \times 13.0$	B32591C1224+***	3600	6000	6000
		0.33	$5.5 \times 9.0 \times 13.0$	B32591C1334+***	2720	5200	6000
		0.47	$6.0 \times 9.5 \times 13.0$	B32591C1474+***	2400	5200	4000
		0.68	$7.0 \times 10.5 \times 13.0$	B32591C1684+***	2000	4000	4000
		1.0	$8.0 \times 15.0 \times 13.0$	B32591C1105+***	1800	3600	2000
250	160	0.033	$5.0 \times 9.0 \times 13.0$	B32591C3333+***	3600	6000	6000
		0.047	$5.0 \times 9.0 \times 13.0$	B32591C3473+***	3600	6000	6000
		0.068	$5.0 \times 9.0 \times 13.0$	B32591C3683+***	3600	6000	6000
		0.10	$5.0 \times 9.0 \times 13.0$	B32591C3104+***	3600	6000	4000
		0.15	$5.5 \times 10.0 \times 13.0$	B32591C3154+***	2720	5200	4000
		0.22	$6.0 \times 10.5 \times 13.0$	B32591C3224+***	2720	5200	4000
		0.33	$6.5 \times 11.0 \times 13.0$	B32591C3334+***	2320	4400	4000
0.47	$8.0 \times 13.5 \times 13.0$	B32591C3474+***	1800	3600	2000		
400	200	0.010	$5.0 \times 9.0 \times 13.0$	B32591C6103+***	3320	6000	6000
		0.015	$5.0 \times 9.0 \times 13.0$	B32591C6153+***	3320	6000	6000
		0.022	$5.0 \times 9.0 \times 13.0$	B32591C6223+***	3320	6000	6000
		0.033	$5.0 \times 9.0 \times 13.0$	B32591C6333+***	3320	6000	6000
		0.047	$5.0 \times 10.5 \times 13.0$	B32591C6473+***	3320	6000	4000
		0.068	$5.5 \times 10.5 \times 13.0$	B32591C6683+***	3320	5200	4000
		0.10	$6.0 \times 11.5 \times 13.0$	B32591C6104+***	3120	5200	4000
630	200	0.010 ∇	$6.5 \times 10.5 \times 13.0$	B32591C8103+***	2400	4400	2000
		0.015 ∇	$6.5 \times 10.5 \times 13.0$	B32591C8153+***	2400	4400	2000
		0.022 ∇	$7.5 \times 11.5 \times 13.0$	B32591C8223+***	2000	4000	2000

∇ Wound capacitor technology

MOQ = Minimum Order Quantity, consisting of 4 packing units.

Further E series and intermediate capacitance values on request.

Composition of ordering code

+ = Capacitance tolerance code:

M = $\pm 20\%$

K = $\pm 10\%$

J = $\pm 5\%$

*** = Packaging code:

289 = Ammo pack

189 = Reel

010 = Untaped (lead length 6 – 1 mm)

011 = Untaped (lead length min. 20 mm)

008 = Untaped straight (lead length 17 ± 3 mm)

Packaging codes for further lead configurations (untaped):

Reduced lead configuration (lead length 6 – 1 mm)	Reduced	Reduced
Lead spacing (mm) / Packaging code	5 / 035	7.5 / 030

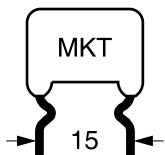
B32592
General purpose (stacked/wound)
Ordering codes and packing units (lead spacing 15 mm)

V_R	V_{RMS} $f \leq 60$ Hz	C_R	Max. dimensions $w \times h \times l$ mm	Ordering code (composition see below)	Ammo pack pcs./MOQ	Reel pcs./ MOQ	Untaped pcs./ MOQ
V DC	V AC	μF					
100	63	0.47	$5.0 \times 9.5 \times 18.0$	B32592C1474+***	4680	6000	4000
		0.68	$5.5 \times 10.5 \times 18.0$	B32592C1684+***	4000	5200	4000
		1.0	$6.5 \times 10.5 \times 18.0$	B32592C1105+***	3320	4400	2000
		1.5	$7.5 \times 14.0 \times 18.0$	B32592C1155+***	3120	3720	2000
		2.2	$9.0 \times 14.0 \times 18.0$	B32592C1225+***	2560	3320	1000
		3.3	$11.0 \times 17.5 \times 18.0$	B32592C1335+***	2000	2560	1000
		4.7	$11.0 \times 17.5 \times 18.0$	B32592C1475+***	2000	2560	1000
250	160	0.22	$5.5 \times 9.0 \times 18.0$	B32592C3224+***	4000	5200	4000
		0.33	$6.0 \times 10.0 \times 18.0$	B32592C3334+***	3720	5200	2000
		0.47	$7.0 \times 11.0 \times 18.0$	B32592C3474+***	3120	4000	2000
		0.68	$8.0 \times 11.5 \times 18.0$	B32592C3684+***	2720	3600	2000
		1.0	$9.5 \times 13.0 \times 18.0$	B32592C3105+***	2320	3120	2000
400	200	0.068	$5.0 \times 9.0 \times 18.0$	B32592C6683+***	4680	6000	4000
		0.10	$5.0 \times 10.0 \times 18.0$	B32592C6104+***	4680	6000	4000
		0.15	$6.0 \times 10.5 \times 18.0$	B32592C6154+***	3720	5200	4000
		0.22	$7.0 \times 11.0 \times 18.0$	B32592C6224+***	3120	4000	2000
		0.33	$8.0 \times 12.0 \times 18.0$	B32592C6334+***	2720	3600	2000
		0.47	$9.5 \times 13.0 \times 18.0$	B32592C6474+***	2320	3120	1000
		0.68	$10.0 \times 16.0 \times 18.0$	B32592C6684+***	2020	2800	1000
630	200	0.033 ▽	$6.5 \times 10.5 \times 18.0$	B32592C8333+***	3320	4400	4000
		0.047 ▽	$7.0 \times 12.0 \times 18.0$	B32592C8473+***	3120	4000	2000
		0.068 ▽	$7.5 \times 14.0 \times 18.0$	B32592C8683+***	3120	3720	2000
		0.10 ▽	$8.5 \times 15.0 \times 18.0$	B32592C8104+***	2560	3320	2000

▽ Wound capacitor technology

MOQ = Minimum Order Quantity, consisting of 4 packing units.

Further E series and intermediate capacitance values on request.

Composition of ordering code

+ = Capacitance tolerance code:

 M = $\pm 20\%$

 K = $\pm 10\%$

 J = $\pm 5\%$

*** = Packaging code:

289 = Ammo pack

189 = Reel

010 = Untaped (lead length 6 – 1 mm)

011 = Untaped (lead length min. 20 mm)

 008 = Untaped straight (lead length 17 ± 3 mm)

Packaging codes for further lead configurations (untaped):

Lead configuration (lead length 6 – 1 mm)	Reduced	Reduced	Reduced	Enlarged
Lead spacing (mm)	7.5	10	12.5	17.5
Packaging code	030	040	050	060

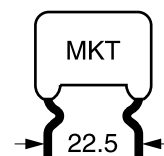
Ordering codes and packing units (lead spacing 22.5 mm)

V_R	V_{RMS} $f \leq 60$ Hz	C_R	Max. dimensions $w \times h \times l$ mm	Ordering code (composition see below)	Ammo pack pcs./MOQ	Reel pcs./ MOQ	Untaped pcs./ MOQ
V DC	V AC	μF					
100	63	1.5	7.0 × 14.0 × 26.5	B32593C1155+***	2000	2800	2000
		2.2	8.5 × 15.0 × 26.5	B32593C1225+***	1800	2400	2000
		3.3	10.0 × 16.5 × 26.5	B32593C1335+***	1520	2160	800
		4.7	11.5 × 18.5 × 26.5	B32593C1475+***	1200	1800	800
		6.8	13.0 × 21.5 × 26.5	B32593C1685+***	1120	1520	800
250	160	0.68	7.0 × 13.0 × 26.5	B32593C3684+***	2000	2800	2000
		1.0	7.0 × 15.5 × 26.5	B32593C3105+***	2000	2800	2000
		1.5	8.5 × 17.0 × 26.5	B32593C3155+***	1600	2320	800
		2.2	10.0 × 18.5 × 26.5	B32593C3225+***	1400	2000	800
400	200	0.22	6.5 × 13.0 × 26.5	B32593C6224+***	2020	3200	2000
		0.33	7.0 × 14.0 × 26.5	B32593C6334+***	2020	3200	2000
		0.47	7.0 × 16.5 × 26.5	B32593C6474+***	2000	2800	2000
630	200	0.10	7.0 × 14.0 × 26.5	B32593C8104+***	2000	2800	2000
		0.15	7.5 × 16.0 × 26.5	B32593C8154+***	1800	2600	1000
		0.22	8.5 × 17.0 × 26.5	B32593C8224+***	1600	2320	1000

MOQ = Minimum Order Quantity, consisting of 4 packing units.
Further E series and intermediate capacitance values on request.

Composition of ordering code

+ = Capacitance tolerance code:

M = ±20%

K = ±10%

J = ±5%

*** = Packaging code:

289 = Ammo pack

189 = Reel

010 = Untaped (lead length 6 – 1 mm)

011 = Untaped (lead length min. 20 mm)

008 = Untaped straight (lead length 17±3 mm)

Packaging codes for further lead configurations (untaped):

Lead configuration (lead length 6 – 1 mm)	Reduced	Reduced	Enlarged
Lead spacing (mm)	17.5	20	25
Packaging code	060	070	080

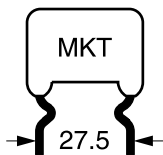
B32594
General purpose (wound)
Ordering codes and packing units (lead spacing 27.5 mm)

V_R	V_{RMS} $f \leq 60 \text{ Hz}$	C_R	Max. dimensions $w \times h \times l$ mm	Ordering code (composition see below)	Untaped pcs./MOQ
V DC	V AC	μF			
100	63	4.7	10.5 × 18.5 × 31.5	B32594C1475+***	800
		6.8	12.5 × 21.0 × 31.5	B32594C1685+***	800
		10	17.0 × 22.0 × 31.5	B32594C1106+***	800
250	160	1.5	8.5 × 16.0 × 31.5	B32594C3155+***	2000
		2.2	10.0 × 17.5 × 31.5	B32594C3225+***	2000
		3.3	12.0 × 19.5 × 31.5	B32594C3335+***	800
		4.7	14.0 × 21.5 × 31.5	B32594C3475+***	800
		6.8	15.0 × 25.0 × 31.5	B32594C3685+***	800
400	200	0.68	8.0 × 16.0 × 31.5	B32594C6684+***	1000
		1.0	9.5 × 18.0 × 31.5	B32594C6105+***	1000
		1.5	11.5 × 20.0 × 31.5	B32594C6155+***	1000
		2.2	13.5 × 22.0 × 31.5	B32594C6225+***	800
630	220	0.33	8.0 × 15.0 × 31.5	B32594C8334+***	1000
		0.47	10.0 × 16.0 × 31.5	B32594C8474+***	800
		0.68	10.5 × 18.0 × 31.5	B32594C8684+***	800

MOQ = Minimum Order Quantity, consisting of 4 packing units.
Further E series and intermediate capacitance values on request.

Composition of ordering code

+ = Capacitance tolerance code:

M = ±20%

K = ±10%

J = ±5%

*** = Packaging code:

010 = Untaped (lead length 6 – 1 mm)

011 = Untaped (lead length min. 20 mm)

008 = Untaped straight (lead length 17±3 mm)

Packaging codes for further lead configurations (untaped):

Lead configuration (lead length 6 – 1 mm)	Reduced
Lead spacing (mm)	25
Packaging code	090

Technical data

Operating temperature range	Max. operating temperature $T_{op,max}$		+125 °C	
	Upper category temperature T_{max}		+100 °C	
	Lower category temperature T_{min}		-55 °C	
	Rated temperature T_R		+85 °C	
Dissipation factor $\tan \delta$ (in 10^{-3}) at 20 °C (upper limit values)	at	$C_R \leq 0.1 \mu F$	$0.1 \mu F < C_R \leq 1 \mu F$	$C_R > 1 \mu F$
	1 kHz	8	10	10
	10 kHz	15	20	—
	100 kHz	30	—	—
Insulation resistance R_{ins} or time constant $\tau = C_R \cdot R_{ins}$ at 20 °C, rel. humidity $\leq 65\%$ (minimum as-delivered values)	V_R	$C_R \leq 0.33 \mu F$		$C_R > 0.33 \mu F$
	100 V DC	3750 M Ω		1250 s
	≥ 250 V DC	7500 M Ω		2500 s
DC test voltage	$1.4 \cdot V_R, 2$ s			
Category voltage V_C (continuous operation with V_{DC} or V_{AC} at $f \leq 60$ Hz)	T_A (°C)	DC voltage derating		AC voltage derating
	$T_A \leq 85$ $85 < T_A \leq 100$	$V_C = V_R$ $V_C = V_R \cdot (165 - T_A)/80$		$V_{C,RMS} = V_{RMS}$ $V_{C,RMS} = V_{RMS} \cdot (165 - T_A)/80$
Operating voltage V_{op} for short operating periods (V_{DC} or V_{AC} at $f \leq 60$ Hz)	T_A (°C)	DC voltage (max. hours)		AC voltage (max. hours)
	$T_A \leq 100$ $100 < T_A \leq 125$	$V_{op} = 1.25 \cdot V_C$ (2000 h) $V_{op} = 1.25 \cdot V_C$ (1000 h)		$V_{op} = 1.0 \cdot V_{C,RMS}$ (2000 h) $V_{op} = 1.0 \cdot V_{C,RMS}$ (1000 h)
Damp heat test Limit values after damp heat test	56 days/40 °C/93% relative humidity			
	Capacitance change $ \Delta C/C $		$\leq 5\%$	
	Dissipation factor change $\Delta \tan \delta$		$\leq 5 \cdot 10^{-3}$ (at 10 kHz)	
	Insulation resistance R_{ins} or time constant $\tau = C_R \cdot R_{ins}$		$\geq 50\%$ of minimum as-delivered values	
Reliability: Failure rate λ Service life t_{SL}	1 fit ($\leq 1 \cdot 10^{-9}/h$) at $0.5 \cdot V_R, 40$ °C 200 000 h at $1.0 \cdot V_R, 85$ °C For conversion to other operating conditions and temperatures, refer to chapter "Quality, 2 Reliability".			
Failure criteria: Total failure Failure due to variation of parameters	Short circuit or open circuit			
	Capacitance change $ \Delta C/C $		$> 10\%$	
	Dissipation factor $\tan \delta$		$> 2 \cdot$ upper limit value	
	Insulation resistance R_{ins} or time constant $\tau = C_R \cdot R_{ins}$		< 150 M Ω ($C_R \leq 0.33 \mu F$) < 50 s ($C_R > 0.33 \mu F$)	

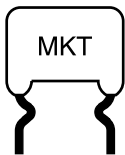

B32591 ... B32594

General purpose (stacked/wound)

Pulse handling capability

"dV/dt" represents the maximum permissible voltage change per unit of time for non-sinusoidal voltages, expressed in V/ μ s.

"k₀" represents the maximum permissible pulse characteristic of the waveform applied to the capacitor, expressed in V²/ μ s.

Note:

The values of dV/dt and k₀ provided below must not be exceeded in order to avoid damaging the capacitor.

dV/dt values

Lead spacing		10 mm		15 mm		22.5 mm	27.5 mm
Technology		Stacked	Wound	Stacked	Wound	Wound	Wound
V _R V DC	V _{RMS} V AC	dV/dt in V/ μ s					
100	63	75	–	50	–	2.5	2
250	160	150	–	100	–	4	3
400	200	175	–	125	–	7	5
630	200	–	20	–	15	10	–
630	220	–	–	–	–	–	8

k₀ values

Lead spacing		10 mm		15 mm		22.5 mm	27.5 mm
Technology		Stacked	Wound	Stacked	Wound	Wound	Wound
V _R V DC	V _{RMS} V AC	k ₀ in V ² / μ s					
100	63	15 000	–	10 000	–	500	400
250	160	75 000	–	50 000	–	2 000	1 500
400	200	140 000	–	100 000	–	5 600	4 000
630	200	–	25 000	–	19 000	12 600	–
630	220	–	–	–	–	–	10 000

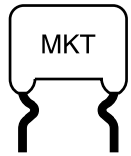

Impedance Z versus frequency f
(typical values)

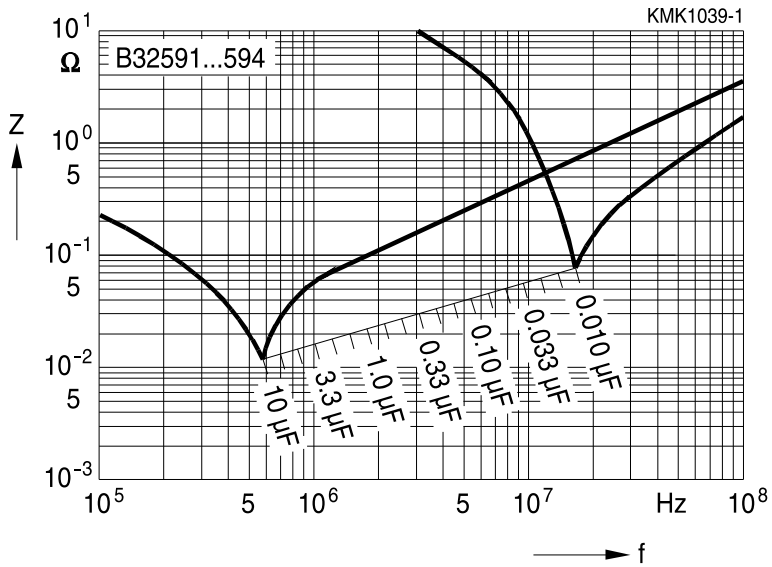

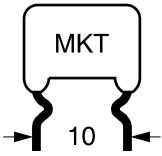

B32591

General purpose (stacked/wound)

Permissible AC voltage V_{RMS} versus frequency f (for sinusoidal waveforms, $T_A \leq 55^\circ C$)

For $T_A > 55^\circ C$, please refer to "General technical information", section 3.2.3.

Lead spacing 10 mm

100 V DC/63 V AC

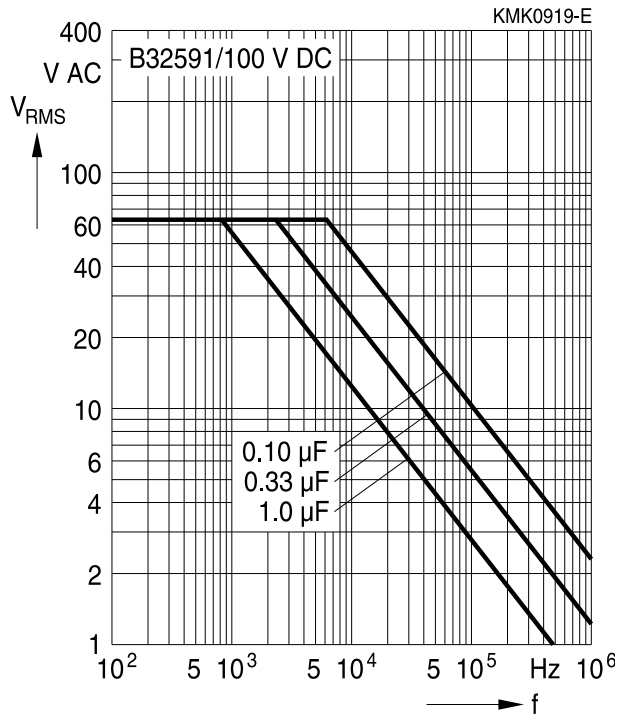

250 V DC/160 V AC

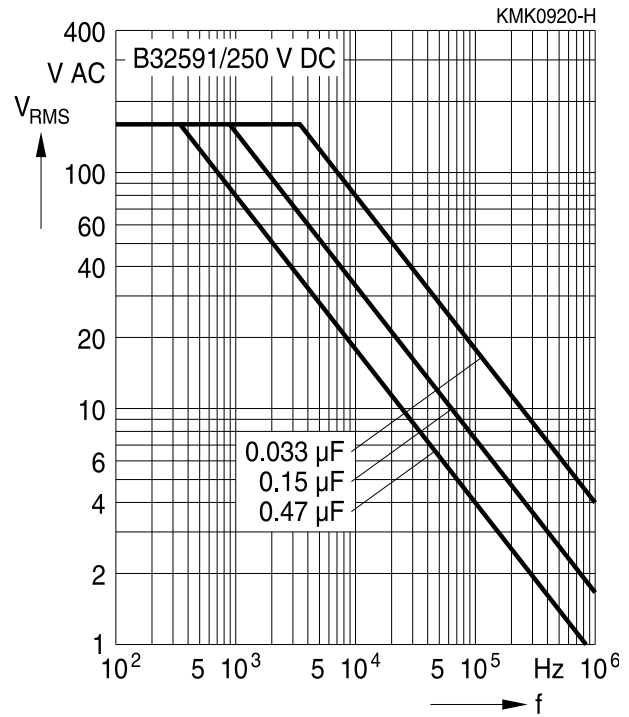

400 V DC/200 V AC

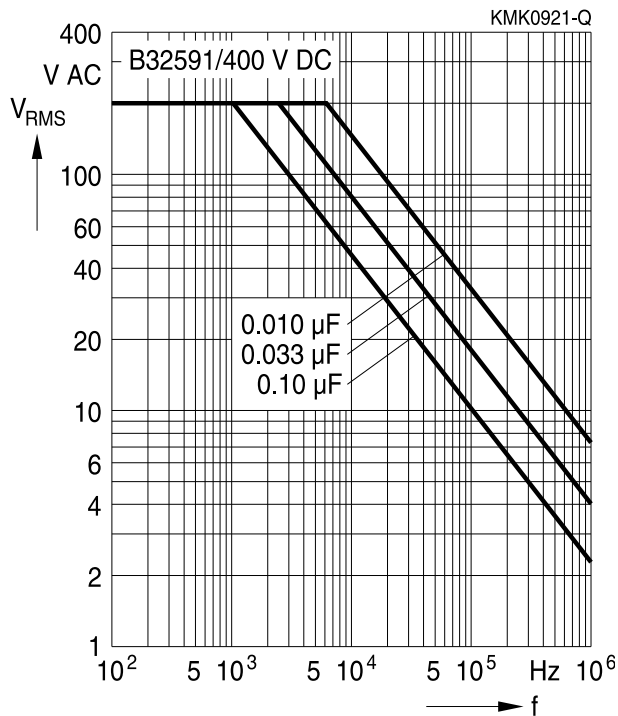

630 V DC/200 V AC

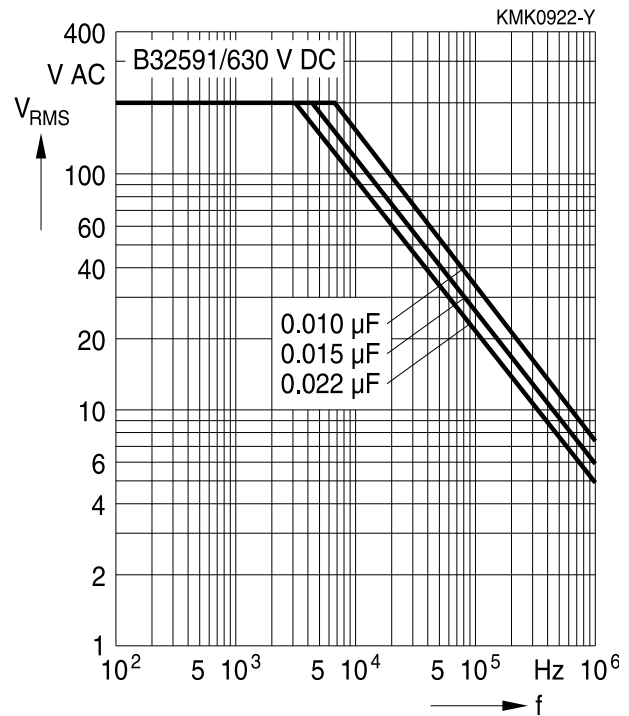

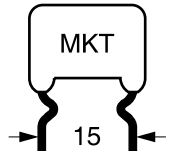

Permissible AC voltage V_{RMS} versus frequency f (for sinusoidal waveforms, $T_A \leq 55^\circ C$)

For $T_A > 55^\circ C$, please refer to "General technical information", section 3.2.3.

Lead spacing 15 mm

100 V DC/63 V AC

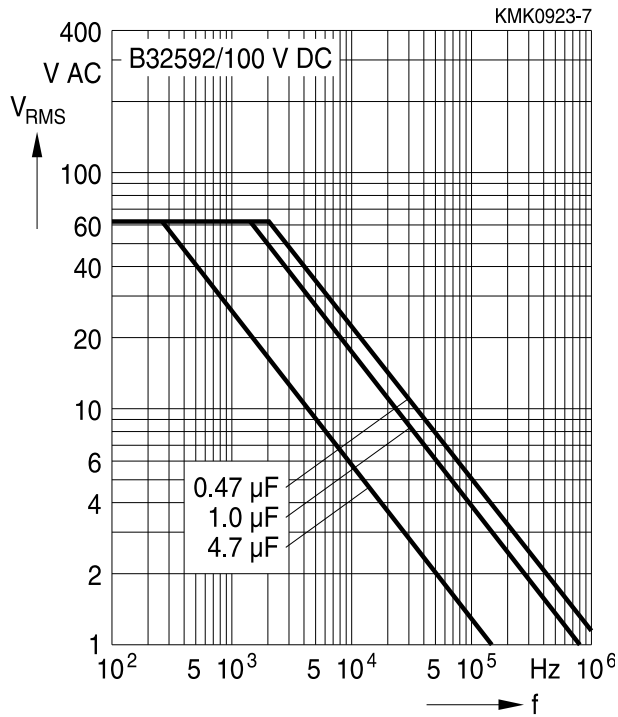

250 V DC/160 V AC

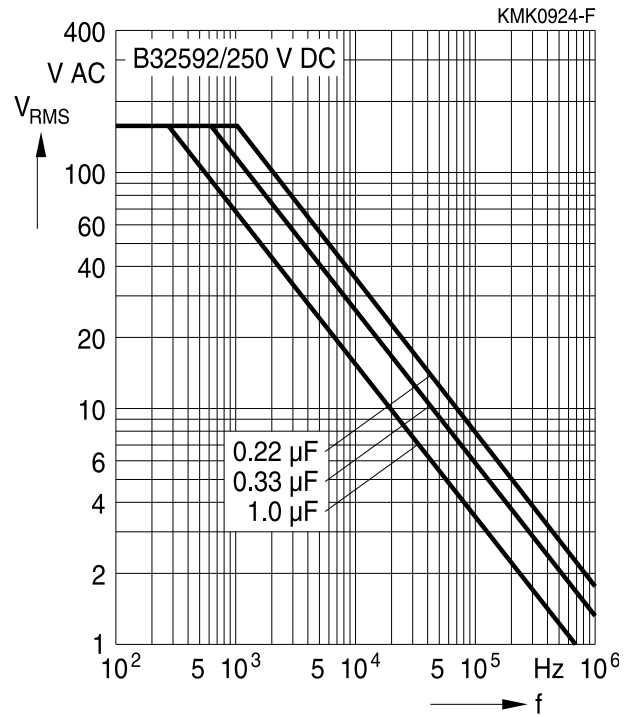

400 V DC/200 V AC

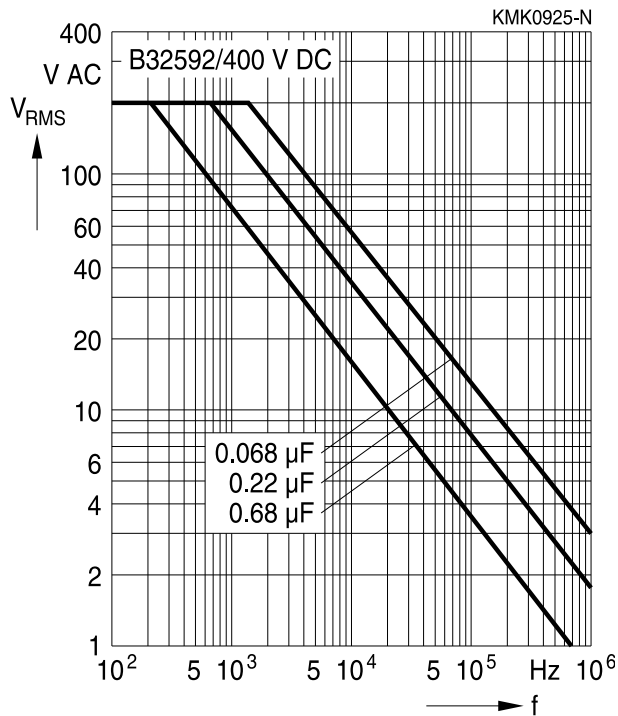

630 V DC/200 V AC

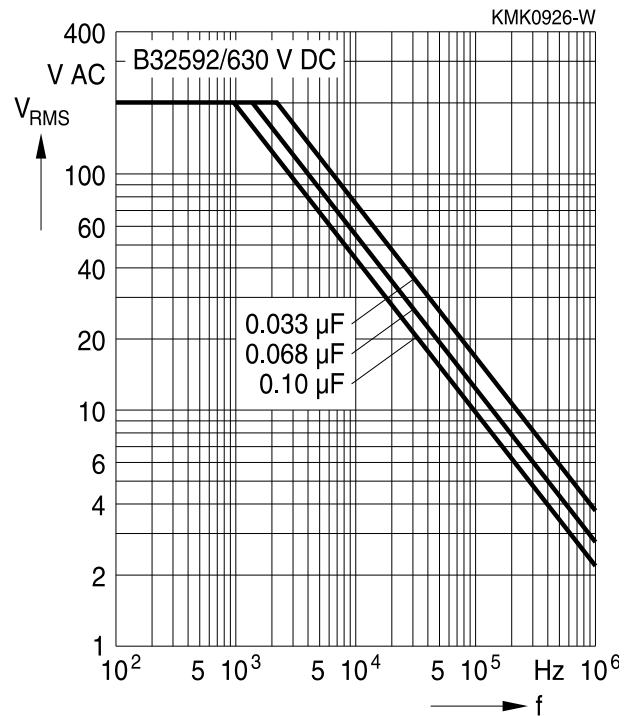

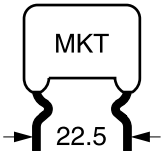

B32593

General purpose (wound)

Permissible AC voltage V_{RMS} versus frequency f (for sinusoidal waveforms, $T_A \leq 55^\circ C$)

For $T_A > 55^\circ C$, please refer to "General technical information", section 3.2.3.

Lead spacing 22.5 mm

100 V DC/63 V AC

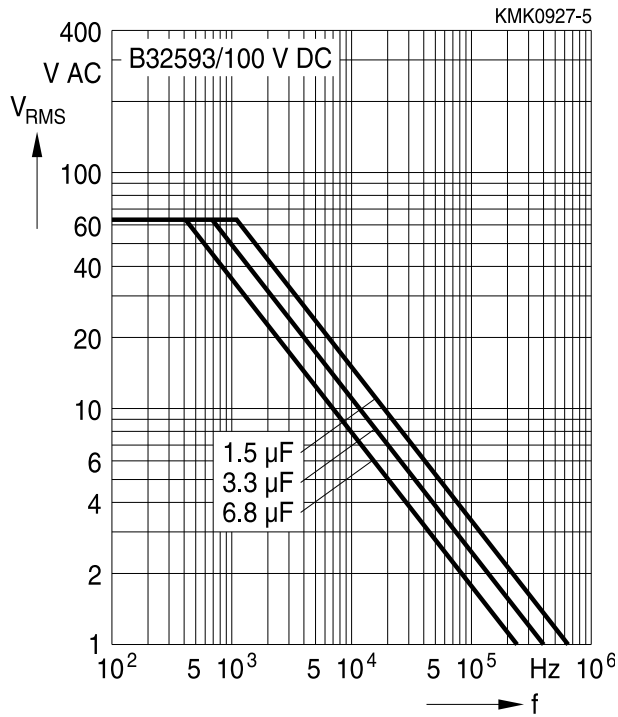

250 V DC/160 V AC

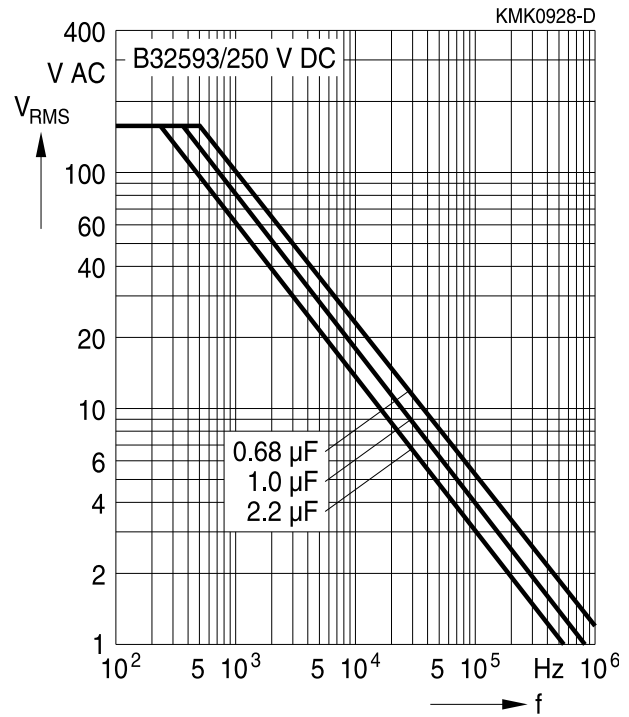

400 V DC/200 V AC

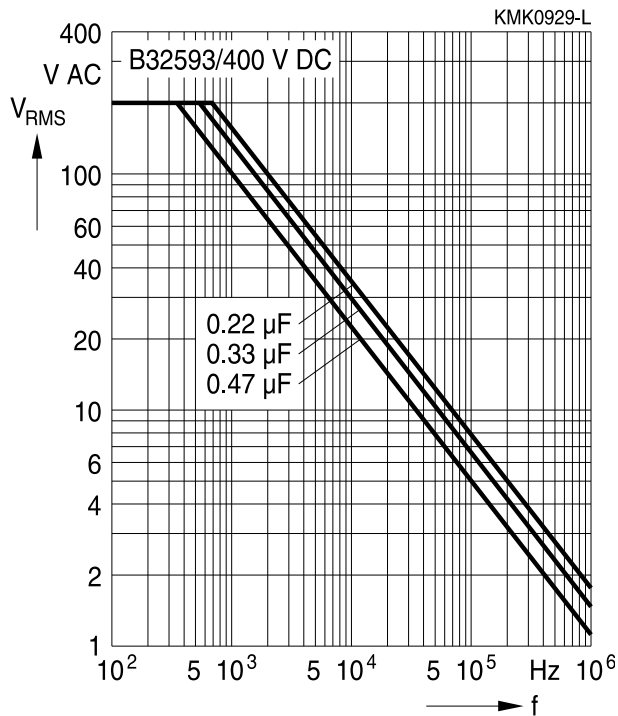

630 V DC/200 V AC

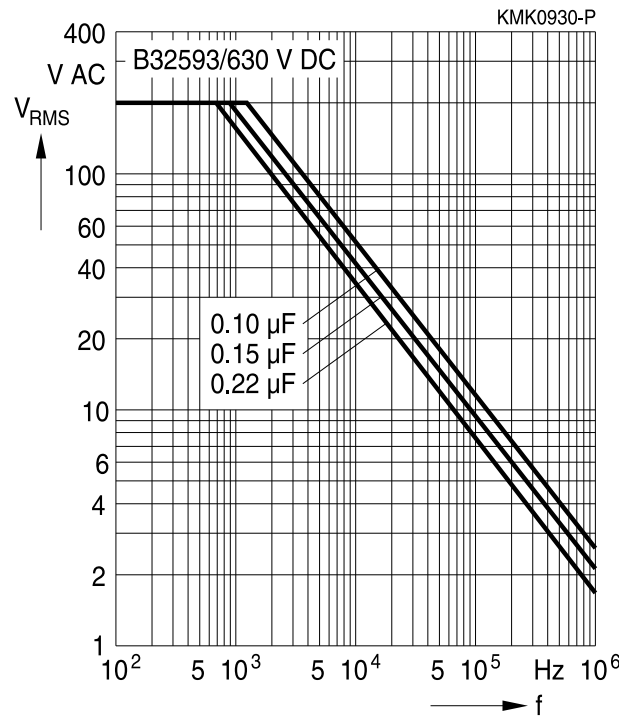

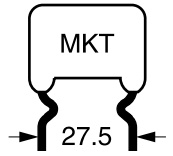

Permissible AC voltage V_{RMS} versus frequency f (for sinusoidal waveforms, $T_A \leq 55^\circ C$)

For $T_A > 55^\circ C$, please refer to "General technical information", section 3.2.3.

Lead spacing 27.5 mm

100 V DC/63 V AC

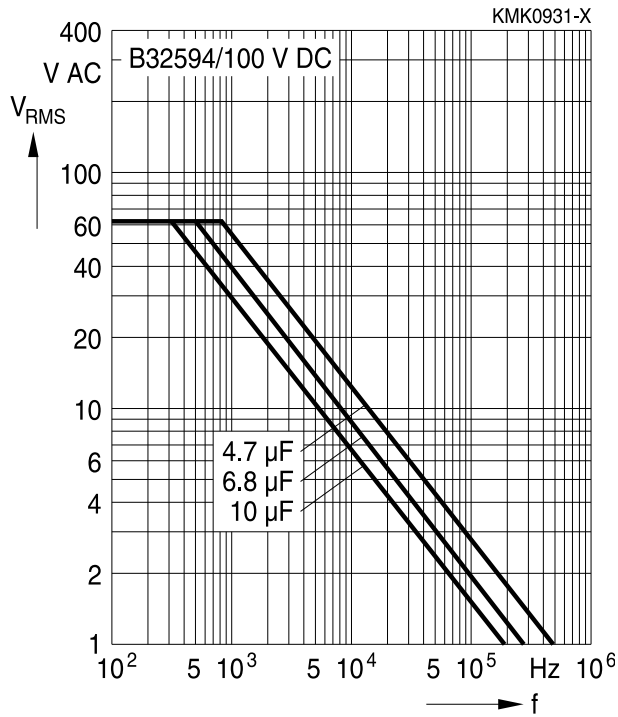

250 V DC/160 V AC

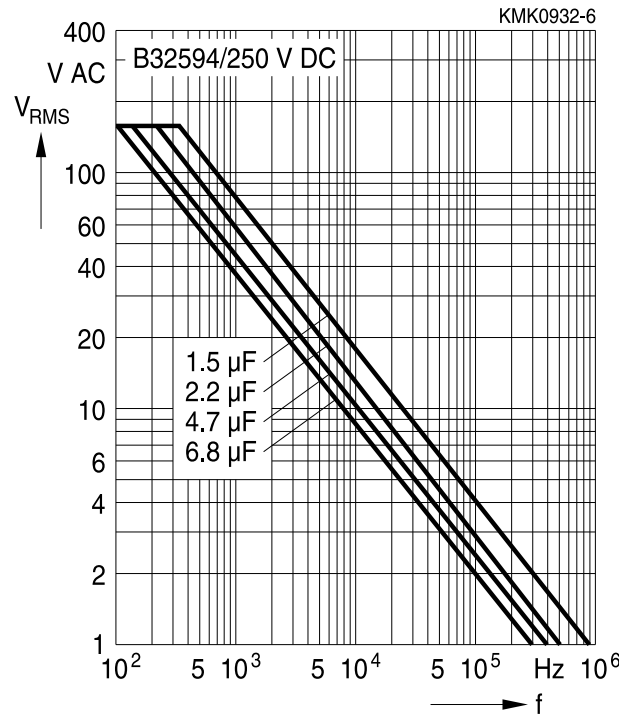

400 V DC/200 V AC

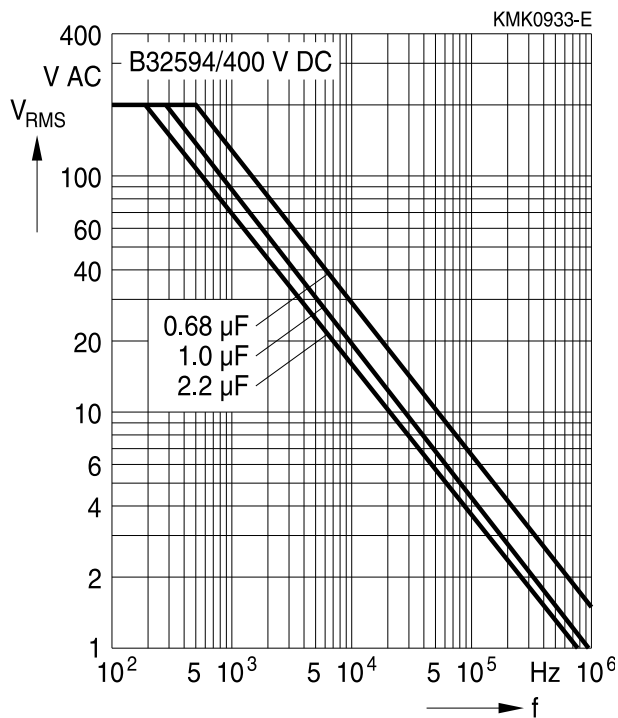

630 V DC/220 V AC

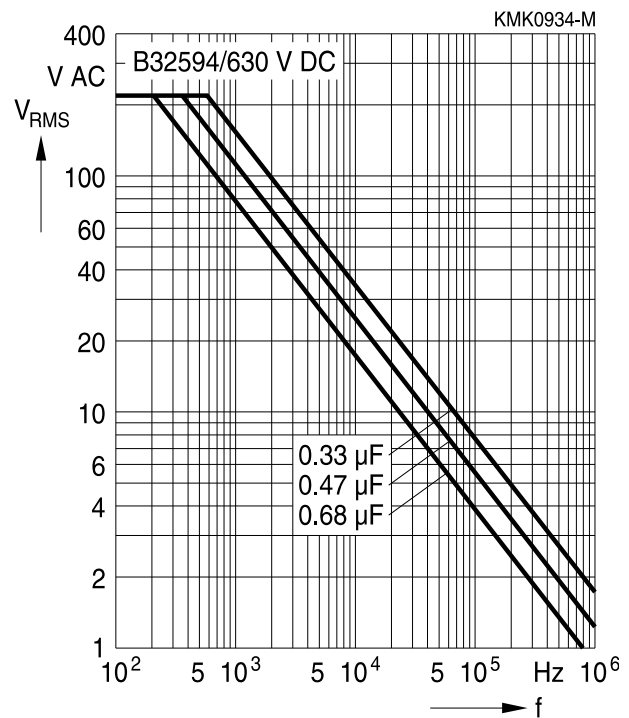

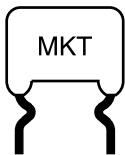

Mounting guidelines

1 Soldering

1.1 Solderability of leads

The solderability of terminal leads is tested to IEC 60068-2-20, test Ta, method 1.

Before a solderability test is carried out, terminals are subjected to accelerated ageing (to IEC 60068-2-2, test Ba: 4 h exposure to dry heat at 155 °C). Since the ageing temperature is far higher than the upper category temperature of the capacitors, the terminal wires should be cut off from the capacitor before the ageing procedure to prevent the solderability being impaired by the products of any capacitor decomposition that might occur.

Solder bath temperature	235 ±5 °C
Soldering time	2.0 ±0.5 s
Immersion depth	2.0 +0/−0.5 mm from capacitor body or seating plane
Evaluation criteria: Visual inspection	Wetting of wire surface by new solder ≥90%, free-flowing solder

1.2 Resistance to soldering heat

Resistance to soldering heat is tested to IEC 60068-2-20, test Tb, method 1A.

Conditions:

Series	Solder bath temperature	Soldering time
MKT boxed (except 2.5 × 6.5 × 7.2 mm) coated uncoated (lead spacing > 10 mm)	260 ±5 °C	10 ±1 s
MFP MKP (lead spacing > 7.5 mm)		
MKT boxed (case 2.5 × 6.5 × 7.2 mm)		5 ±1 s
MKP (lead spacing ≤ 7.5 mm)		< 4 s
MKT uncoated (lead spacing ≤ 10 mm) insulated (B32559)		recommended soldering profile for MKT uncoated (lead spacing ≤ 10 mm) and insulated (B32559)

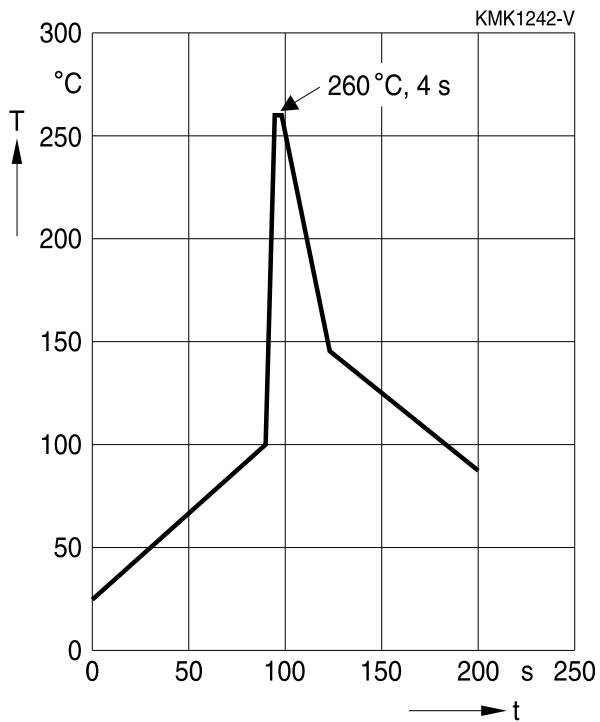
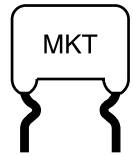

Immersion depth	2.0 +0/−0.5 mm from capacitor body or seating plane
Shield	Heat-absorbing board, (1.5 ±0.5) mm thick, between capacitor body and liquid solder
Evaluation criteria:	
Visual inspection	No visible damage
$\Delta C/C_0$	2% for MKT/MKP/MFP 5% for EMI suppression capacitors
$\tan \delta$	As specified in sectional specification

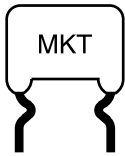

1.3 General notes on soldering

Permissible heat exposure loads on film capacitors are primarily characterized by the upper category temperature T_{max} . Long exposure to temperatures above this type-related temperature limit can lead to changes in the plastic dielectric and thus change irreversibly a capacitor's electrical characteristics. For short exposures (as in practical soldering processes) the heat load (and thus the possible effects on a capacitor) will also depend on other factors like:

- Pre-heating temperature and time
- Forced cooling immediately after soldering
- Terminal characteristics:
diameter, length, thermal resistance, special configurations (e.g. crimping)
- Height of capacitor above solder bath
- Shadowing by neighboring components
- Additional heating due to heat dissipation by neighboring components
- Use of solder-resist coatings

The overheating associated with some of these factors can usually be reduced by suitable countermeasures. For example, if a pre-heating step cannot be avoided, an additional or reinforced cooling process may possibly have to be included.

EPCOS recommends the following conditions:

- Pre-heating with a maximum temperature of 110 °C
- Temperature inside the capacitor should not exceed the following limits:
 - MKP/MFP 110 °C
 - MKT 160 °C
- When SMD components are used together with leaded ones, the leaded film capacitors should not pass into the SMD adhesive curing oven. The leaded components should be assembled after the SMD curing step.
- Leaded film capacitors are not suitable for reflow soldering.

Uncoated capacitors

For uncoated MKT capacitors with lead spacings ≤ 10 mm (B32560/B32561) the following measures are recommended:

- pre-heating to not more than 110 °C in the preheater phase
- rapid cooling after soldering



2 Cleaning

To determine whether the following solvents, often used to remove flux residues and other substances, are suitable for the capacitors described, refer to the table below:

Type	Ethanol, isopropanol, n-propanol	n-propanol-water mixtures, water with surface tension-reducing tensides (neutral)	Solvent from table A (see next page)	Solvent from table B (see next page)
MKT (uncoated)	Suitable	Unsuitable	In part suitable	Unsuitable
MKT, MKP, MFP (coated/boxed)		Suitable	Suitable	

Even when suitable solvents are used, a reversible change of the electrical characteristics may occur in uncoated capacitors immediately after they are washed. Thus it is always recommended to dry the components (e.g. 4 h at 70 °C) before they are subjected to subsequent electrical testing.

Table A

Manufacturers' designations for trifluoro-trichloro-ethane-based cleaning solvents (selection)

Trifluoro-trichloro-ethane	Mixtures of trifluoro-trichloro-ethane with ethanol and isopropanol	Manufacturer
Freon TF	Freon TE 35; Freon TP 35; Freon TES	Du Pont
Frigen 113 TR	Frigen 113 TR-E; Frigen 113 TR-P; Frigen TR-E 35	Hoechst
Arklone P	Arklone A; Arklone L; Arklone K	ICI
Kaltron 113 MDR	Kaltron 113 MDA; Kaltron 113 MDI; Kaltron 113 MDI 35	Kali-Chemie
Flugene 113	Flugene 113 E; Flugene 113 IPA	Rhone-Progil

Table B (worldwide banned substances)

Manufacturers' designations for unsuitable cleaning solvents (selection)

Mixtures of chlorinated hydrocarbons and ketones with fluorated hydrocarbons	Manufacturer
Freon TMC; Freon TA; Freon TC	Du Pont
Arklone E	ICI
Kaltron 113 MDD; Kaltron 113 MDK	Kali-Chemie
Flugene 113 CM	Rhone-Progil

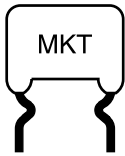

B32591 ... B32594

General purpose (stacked/wound)

3 Embedding of capacitors in finished assemblies

In many applications, finished circuit assemblies are embedded in plastic resins. In this case, both chemical and thermal influences of the embedding ("potting") and curing processes must be taken into account.

Our experience has shown that the following potting materials can be recommended: non-flexible epoxy resins with acid-anhydride hardeners; chemically inert, non-conducting fillers; maximum curing temperature of 100 °C.

Caution:

Consult us first if you wish to embed uncoated types!

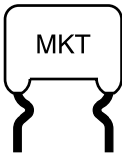

Cautions and warnings

- Do not exceed the upper category temperature (UCT).
- Do not apply any mechanical stress to the capacitor terminals.
- Avoid any compressive, tensile or flexural stress.
- Do not move the capacitor after it has been soldered to the PC board.
- Do not pick up the PC board by the soldered capacitor.
- Do not place the capacitor on a PC board whose PTH hole spacing differs from the specified lead spacing.
- Do not exceed the specified time or temperature limits during soldering.
- Avoid external energy inputs, such as fire or electricity.
- Avoid overload of the capacitors.

The table below summarizes the safety instructions that must always be observed. A detailed description can be found in the relevant sections of the chapters "General technical information" and "Mounting guidelines".

Topic	Safety information	Reference chapter "General technical information"
Storage conditions	Make sure that capacitors are stored within the specified range of time, temperature and humidity conditions.	4.5 "Storage conditions"
Flammability	Avoid external energy, such as fire or electricity (passive flammability), avoid overload of the capacitors (active flammability) and consider the flammability of materials.	5.3 "Flammability"
Resistance to vibration	Do not exceed the tested ability to withstand vibration. The capacitors are tested to IEC 60068-2-6. EPCOS offers film capacitors specially designed for operation under more severe vibration regimes such as those found in automotive applications. Consult our catalog "Film Capacitors for Automotive Electronics".	5.2 "Resistance to vibration"

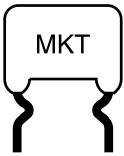

B32591 ... B32594

General purpose (stacked/wound)

Topic	Safety information	Reference chapter "Mounting guidelines"
Soldering	Do not exceed the specified time or temperature limits during soldering.	1 "Soldering"
Cleaning	Use only suitable solvents for cleaning capacitors.	2 "Cleaning"
Embedding of capacitors in finished assemblies	When embedding finished circuit assemblies in plastic resins, chemical and thermal influences must be taken into account. Caution: Consult us first, if you also wish to embed other uncoated component types!	3 "Embedding of capacitors in finished assemblies"

Symbols and terms

Symbol	English	German
α	Heat transfer coefficient	Wärmeübergangszahl
α_C	Temperature coefficient of capacitance	Temperaturkoeffizient der Kapazität
A	Capacitor surface area	Kondensatoroberfläche
β_C	Humidity coefficient of capacitance	Feuchtekoeffizient der Kapazität
C	Capacitance	Kapazität
C_R	Rated capacitance	Nennkapazität
ΔC	Absolute capacitance change	Absolute Kapazitätsänderung
$\Delta C/C$	Relative capacitance change (relative deviation of actual value)	Relative Kapazitätsänderung (relative Abweichung vom Ist-Wert)
$\Delta C/C_R$	Capacitance tolerance (relative deviation from rated capacitance)	Kapazitätstoleranz (relative Abweichung vom Nennwert)
dt	Time differential	Differentielle Zeit
Δt	Time interval	Zeitintervall
ΔT	Absolute temperature change (self-heating)	Absolute Temperaturänderung (Selbsterwärmung)
$\Delta \tan \delta$	Absolute change of dissipation factor	Absolute Änderung des Verlustfaktors
ΔV	Absolute voltage change	Absolute Spannungsänderung
dV/dt	Time differential of voltage function (rate of voltage rise)	Differentielle Spannungsänderung (Spannungsflankensteilheit)
$\Delta V/\Delta t$	Voltage change per time interval	Spannungsänderung pro Zeitintervall
E	Activation energy for diffusion	Aktivierungsenergie zur Diffusion
ESL	Self-inductance	Eigeninduktivität
ESR	Equivalent series resistance	Ersatz-Serienwiderstand
f	Frequency	Frequenz
f_1	Frequency limit for reducing permissible AC voltage due to thermal limits	Grenzfrequenz für thermisch bedingte Reduzierung der zulässigen Wechselspannung
f_2	Frequency limit for reducing permissible AC voltage due to current limit	Grenzfrequenz für strombedingte Reduzierung der zulässigen Wechselspannung
f_r	Resonant frequency	Resonanzfrequenz
F_D	Thermal acceleration factor for diffusion	Therm. Beschleunigungsfaktor zur Diffusion
F_T	Derating factor	Deratingfaktor
i	Current (peak)	Stromspitze
I_C	Category current (max. continuous current)	Kategoriestrom (max. Dauerstrom)

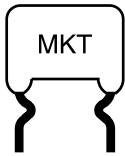

B32591 ... B32594

General purpose (stacked/wound)

Symbol	English	German
I_{RMS}	(Sinusoidal) alternating current, root-mean-square value	(Sinusförmiger) Wechselstrom
i_z	Capacitance drift	Inkonstanz der Kapazität
k_0	Pulse characteristic	Impulskennwert
L_S	Series inductance	Serieninduktivität
λ	Failure rate	Ausfallrate
λ_0	Constant failure rate during useful service life	Konstante Ausfallrate in der Nutzungsphase
λ_{test}	Failure rate, determined by tests	Experimentell ermittelte Ausfallrate
P_{diss}	Dissipated power	Abgegebene Verlustleistung
P_{gen}	Generated power	Erzeugte Verlustleistung
Q	Heat energy	Wärmeenergie
ρ	Density of water vapor in air	Dichte von Wasserdampf in Luft
R	Universal molar constant for gases	Allg. Molarkonstante für Gas
R	Ohmic resistance of discharge circuit	Ohmscher Widerstand des Entladekreises
R_i	Internal resistance	Innenwiderstand
R_{ins}	Insulation resistance	Isolationswiderstand
R_P	Parallel resistance	Parallelwiderstand
R_S	Series resistance	Serienwiderstand
S	severity (humidity test)	Schärfegrad (Feuchtetest)
t	Time	Zeit
T	Temperature	Temperatur
τ	Time constant	Zeitkonstante
$\tan \delta$	Dissipation factor	Verlustfaktor
$\tan \delta_D$	Dielectric component of dissipation factor	Dielektrischer Anteil des Verlustfaktors
$\tan \delta_P$	Parallel component of dissipation factor	Parallelanteil des Verlustfaktors
$\tan \delta_S$	Series component of dissipation factor	Serienanteil des Verlustfaktors
T_A	Ambient temperature	Umgebungstemperatur
T_{max}	Upper category temperature	Obere Kategorietemperatur
T_{min}	Lower category temperature	Untere Kategorietemperatur
t_{OL}	Operating life at operating temperature and voltage	Betriebszeit bei Betriebstemperatur und -spannung
T_{op}	Operating temperature	Betriebstemperatur
T_R	Rated temperature	Nenntemperatur
T_{ref}	Reference temperature	Referenztemperatur
t_{SL}	Reference service life	Referenz-Lebensdauer
V_{AC}	AC voltage	Wechselspannung

Symbol	English	German
V_C	Category voltage	Kategorie ­ spannung
$V_{C,RMS}$	Category AC voltage	(Sinusförmige) Kategorie-Wechselspannung
V_{CD}	Corona-discharge onset voltage	Teilentlade-Einsatzspannung
V_{ch}	Charging voltage	Ladespannung
V_{DC}	DC voltage	Gleichspannung
V_{FB}	Fly-back capacitor voltage	Spannung (Flyback)
V_i	Input voltage	Eingangsspannung
V_o	Output voltage	Ausgangsspannung
V_{op}	Operating voltage	Betriebsspannung
V_p	Peak pulse voltage	Impuls-Spitzen ­ spannung
V_{pp}	Peak-to-peak voltage Impedance	Spannungshub
V_R	Rated voltage	Nennspannung
\hat{V}_R	Amplitude of rated AC voltage	Amplitude der Nenn-Wechselspannung
V_{RMS}	(Sinusoidal) alternating voltage, root-mean-square value	(Sinusförmige) Wechselspannung
V_{SC}	S-correction voltage	Spannung bei Anwendung "S-correction"
V_{sn}	Snubber capacitor voltage	Spannung bei Anwendung "Beschaltung"
Z	Impedance	Scheinwiderstand
e	Lead spacing	Rastermaß

Important notes

The following applies to all products named in this publication:

1. Some parts of this publication contain **statements about the suitability of our products for certain areas of application**. These statements are based on our knowledge of typical requirements that are often placed on our products in the areas of application concerned. We nevertheless expressly point out **that such statements cannot be regarded as binding statements about the suitability of our products for a particular customer application**. As a rule, EPCOS is either unfamiliar with individual customer applications or less familiar with them than the customers themselves. For these reasons, it is always ultimately incumbent on the customer to check and decide whether an EPCOS product with the properties described in the product specification is suitable for use in a particular customer application.
2. We also point out that **in individual cases, a malfunction of electronic components or failure before the end of their usual service life cannot be completely ruled out in the current state of the art, even if they are operated as specified**. In customer applications requiring a very high level of operational safety and especially in customer applications in which the malfunction or failure of an electronic component could endanger human life or health (e.g. in accident prevention or lifesaving systems), it must therefore be ensured by means of suitable design of the customer application or other action taken by the customer (e.g. installation of protective circuitry or redundancy) that no injury or damage is sustained by third parties in the event of malfunction or failure of an electronic component.
3. **The warnings, cautions and product-specific notes must be observed.**
4. In order to satisfy certain technical requirements, **some of the products described in this publication may contain substances subject to restrictions in certain jurisdictions (e.g. because they are classed as hazardous)**. Useful information on this will be found in our Material Data Sheets on the Internet (www.epcos.com/material). Should you have any more detailed questions, please contact our sales offices.
5. We constantly strive to improve our products. Consequently, **the products described in this publication may change from time to time**. The same is true of the corresponding product specifications. Please check therefore to what extent product descriptions and specifications contained in this publication are still applicable before or when you place an order. We also **reserve the right to discontinue production and delivery of products**. Consequently, we cannot guarantee that all products named in this publication will always be available. The aforementioned does not apply in the case of individual agreements deviating from the foregoing for customer-specific products.
6. Unless otherwise agreed in individual contracts, **all orders are subject to the current version of the "General Terms of Delivery for Products and Services in the Electrical Industry" published by the German Electrical and Electronics Industry Association (ZVEI)**.
7. The trade names EPCOS, BAOKE, Alu-X, CeraDiode, CSMP, CSSP, CTVS, DSSP, MiniBlue, MKK, MLSC, MotorCap, PCC, PhaseCap, PhaseCube, PhaseMod, SIFERRIT, SIFI, SIKOREL, SilverCap, SIMDAD, SIMID, SineFormer, SIOV, SIP5D, SIP5K, ThermoFuse, WindCap are **trademarks registered or pending** in Europe and in other countries. Further information will be found on the Internet at www.epcos.com/trademarks.