

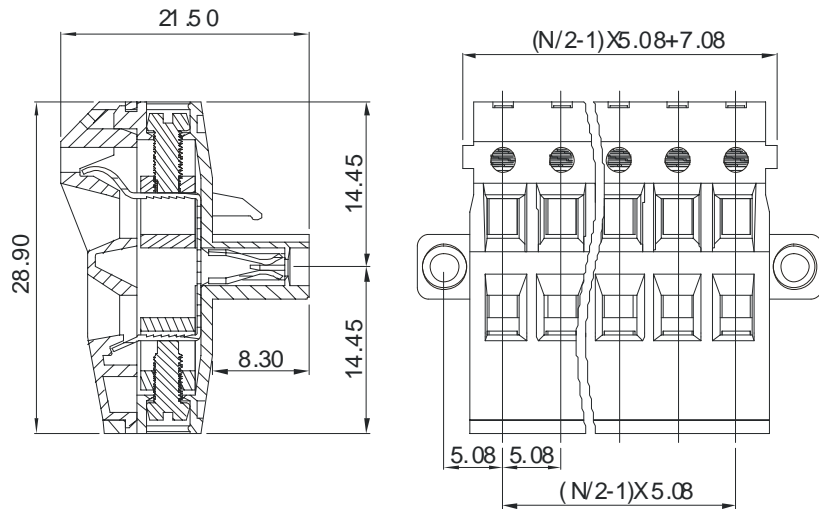





2EDGKHM-5.08

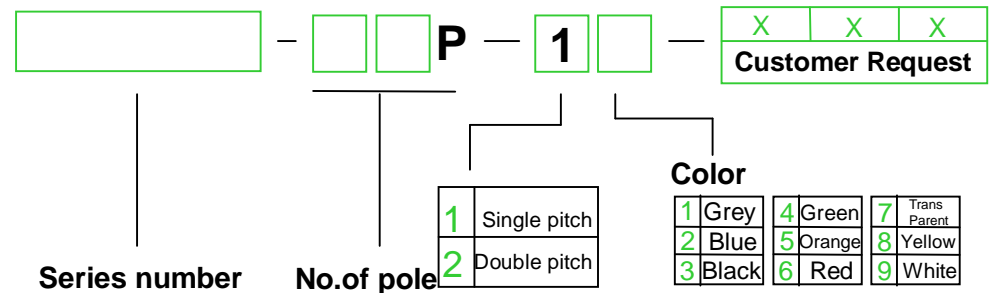

APPROVAL		
Electrical		
Standard	UL	IEC
Rated voltage	300V	320V
Rated current	10A	15A
Wire range	28-12AWG	2.5mm ²
Withstanding voltage	AC2500V/1Min	
Mechanical		
Torque	0.4Nm(3.5Lb-In)	
Ambient temperature	-40°C~+105 °C	
Strip length	10mm	
Dimensions		
Pitch	5.08mm(.200")	
Poles	2P-12P	
Material		
Housing	PA66,UL94V-0	
Screws	M2.5,Steel,Cr ³⁺ Zn- plated	
Contact	Phosphor bronze	
Cage	Brass,Ni- plated	

HOW TO ORDER :

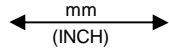

	 DEGSON ELECTRONICS CO., LTD.
	NAME 2EDGKHM-5.08