

# 8-Pin DIP High-Speed 10 MBit/s Logic Gate Optocouplers



ON Semiconductor®

[www.onsemi.com](http://www.onsemi.com)

## Single-Channel: 6N137M, HCPL2601M, HCPL2611M Dual-Channel: HCPL2630M, HCPL2631M

### Description

The 6N137M, HCPL2601M, HCPL2611M single-channel and HCPL2630M, HCPL2631M dual-channel optocouplers consist of a 850 nm AlGaAs LED, optically coupled to a very high speed integrated photo-detector logic gate with a strobable output. This output features an open collector, thereby permitting wired OR outputs. The switching parameters are guaranteed over the temperature range of  $-40^{\circ}\text{C}$  to  $+85^{\circ}\text{C}$ . A maximum input signal of 5 mA will provide a minimum output sink current of 13 mA (fan out of 8).

An internal noise shield provides superior common mode rejection of typically 10 kV/ $\mu\text{s}$ . The HCPL2601M and HCPL2631M has a minimum CMR of 5 kV/ $\mu\text{s}$ . The HCPL2611M has a minimum CMR of 10 kV/ $\mu\text{s}$ .

### Features

- Very High Speed – 10 MBit/s
- Superior CMR – 10 kV/ $\mu\text{s}$
- Fan-out of 8 Over  $-40^{\circ}\text{C}$  to  $+85^{\circ}\text{C}$
- Logic Gate Output
- Storable Output
- Wired OR–open Collector
- Safety and Regulatory Approvals
  - ◆ UL1577, 5,000 VAC<sub>RMS</sub> for 1 Minute
  - ◆ DIN EN/IEC60747–5–5
- These are Pb–Free Devices

### Applications

- Ground Loop Elimination
- LSTTL to TTL, LSTTL or 5 V CMOS
- Line Receiver, Data Transmission
- Data Multiplexing
- Switching Power Supplies
- Pulse Transformer Replacement
- Computer–peripheral Interface

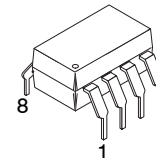

PDIP8 6.6x3.81, 2.54P  
CASE 646BW

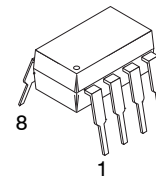

PDIP8 9.655x6.6, 2.54P  
CASE 646CQ

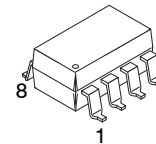

PDIP8 GW  
CASE 709AC

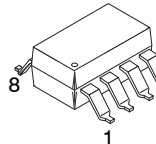

PDIP8 GW  
CASE 709AD

### MARKING DIAGRAM

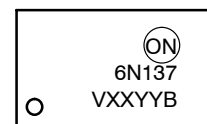

- 6N137 = Device Number  
 V = DIN EN/IEC60747–5–5 Option (only appears on component ordered with this option)  
 XX = Two-Digit Year Code, e.g., '16'  
 YY = Two-Digit Work Week, Ranging from '01' to '53'  
 B = Assembly Package Code

### ORDERING INFORMATION

See detailed ordering and shipping information on page 14 of this data sheet.

Single-Channel: 6N137M, HCPL2601M, HCPL2611M Dual-Channel: HCPL2630M, HCPL2631M

SCHEMATICS

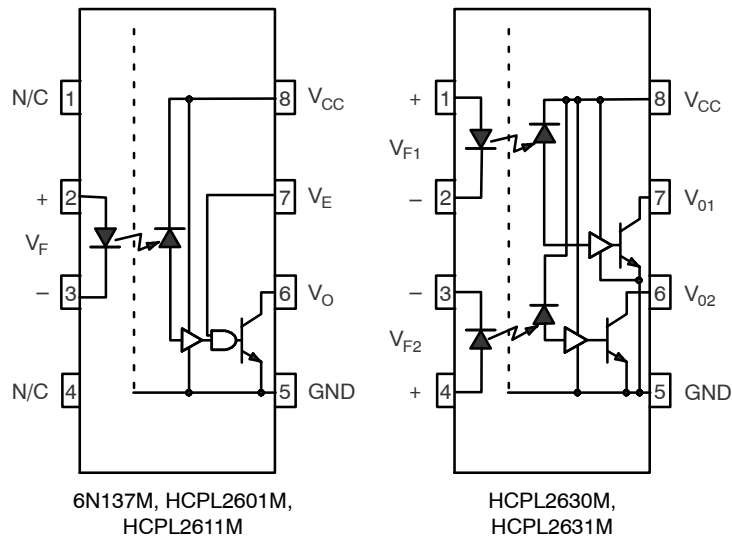

A 0.1  $\mu$ F bypass capacitor must be connected between pins 8 and 5 (Note 1).

Figure 1. Schematics

TRUTH TABLE (Positive Logic)

| Input | Enable | Output |
|-------|--------|--------|
| H     | H      | L      |
| L     | H      | H      |
| H     | L      | H      |
| L     | L      | H      |
| H     | NC     | L      |
| L     | NC     | H      |

**Single-Channel: 6N137M, HCPL2601M, HCPL2611M Dual-Channel: HCPL2630M, HCPL2631M**

**SAFETY AND INSULATION RATINGS** (As per DIN EN/IEC 60747-5-5, this optocoupler is suitable for “safe electrical insulation” only within the safety limit data. Compliance with the safety ratings shall be ensured by means of protective circuits.)

| Parameter   |                       | Characteristics |
|---|-----------------------|-----------------|
| Installation Classifications per DIN VDE 0110/1.89 Table 1, For Rated Mains Voltage | <150 V <sub>RMS</sub> | I-IV            |
|   | <300 V <sub>RMS</sub> | I-IV            |
|   | <450 V <sub>RMS</sub> | I-III           |
|   | <600 V <sub>RMS</sub> | I-III           |
| Climatic Classification   |                       | 40/100/21       |
| Pollution Degree (DIN VDE 0110/1.89)  |                       | 2               |
| Comparative Tracking Index  |                       | 175             |

| Symbol                | Parameter  | Value            | Unit              |
|-----------------------|--|------------------|-------------------|
| V <sub>PR</sub>       | Input-to-Output Test Voltage, Method A, V <sub>IORM</sub> × 1.6 = V <sub>PR</sub> , Type and Sample Test with t <sub>m</sub> = 10 s, Partial Discharge < 5 pC  | 1,335            | V <sub>peak</sub> |
|                       | Input-to-Output Test Voltage, Method B, V <sub>IORM</sub> × 1.875 = V <sub>PR</sub> , 100% Production Test with t <sub>m</sub> = 1 s, Partial Discharge < 5 pC | 1,669            | V <sub>peak</sub> |
| V <sub>IORM</sub>     | Maximum Working Insulation Voltage   | 890              | V <sub>peak</sub> |
| V <sub>IOTM</sub>     | Highest Allowable Over-Voltage   | 6,000            | V <sub>peak</sub> |
|                       | External Creepage  | ≥8.0             | mm                |
|                       | External Clearance   | ≥7.4             | mm                |
|                       | External Clearance (for Option TV, 0.4" Lead Spacing)  | ≥10.16           | mm                |
| DTI                   | Distance Through Insulation (Insulation Thickness)   | ≥0.5             | mm                |
| T <sub>S</sub>        | Case Temperature (Note 2)  | 150              | °C                |
| I <sub>S,INPUT</sub>  | Input Current (Note 2)   | 200              | mA                |
| P <sub>S,OUTPUT</sub> | Output Power (Duty Factor ≤ 2.7%) (Note 2)   | 300              | mW                |
| R <sub>IO</sub>       | Insulation Resistance at T <sub>S</sub> , V <sub>IO</sub> = 500 V (Note 2)   | >10 <sup>9</sup> | Ω                 |

- The V<sub>CC</sub> supply to each optoisolator must be bypassed by a 0.1 μF capacitor or larger. This can be either a ceramic or solid tantalum capacitor with good high frequency characteristic and should be connected as close as possible to the package V<sub>CC</sub> and GND pins of each device.
- Safety limit value – maximum values allowed in the event of a failure.

**Single-Channel: 6N137M, HCPL2601M, HCPL2611M Dual-Channel: HCPL2630M, HCPL2631M**

**ABSOLUTE MAXIMUM RATINGS** ( $T_A = 25^\circ\text{C}$  unless otherwise noted)

| Symbol    | Parameter               | Device | Value        | Unit             |
|-----------|-------------------------|--------|--------------|------------------|
| $T_{STG}$ | Storage Temperature     |        | -40 to +125  | $^\circ\text{C}$ |
| $T_{OPR}$ | Operating Temperature   |        | -40 to +100  | $^\circ\text{C}$ |
| $T_J$     | Junction Temperature    |        | -40 to +125  | $^\circ\text{C}$ |
| $T_{SOL}$ | Lead Solder Temperature |        | 260 for 10 s | $^\circ\text{C}$ |

**EMITTER**

|             |   |                |     |    |
|-------------|---|----------------|-----|----|
| $I_F$ (avg) | DC/Average Forward Input Current Per Channel                    | Single Channel | 50  | mA |
|             |   | Dual Channel   | 30  |    |
| $V_E$       | Enable Input Voltage Not to Exceed $V_{CC}$ by More than 500 mV | Single Channel | 5.5 | V  |
| $V_R$       | Reverse Input Voltage Per Channel                               | All            | 5.0 | V  |
| $P_I$       | Input Power Dissipation Per Channel                             | Single Channel | 100 | mW |
|             |   | Dual Channel   | 45  |    |

**DETECTOR**

|             |                                      |                |             |    |
|-------------|--------------------------------------|----------------|-------------|----|
| $V_{CC}$    | Supply Voltage                       | All            | -0.5 to 7.0 | V  |
| $I_O$ (avg) | Average Output Current Per Channel   | All            | 25          | mA |
| $I_O$ (pk)  | Peak Output Current Per Channel      | All            | 50          | mA |
| $V_O$       | Output Voltage Per Channel           | All            | -0.5 to 7.0 | V  |
| $P_O$       | Output Power Dissipation Per Channel | Single Channel | 85          | mW |
|             |                                      | Dual Channel   | 60          |    |

Stresses exceeding those listed in the Maximum Ratings table may damage the device. If any of these limits are exceeded, device functionality should not be assumed, damage may occur and reliability may be affected.

**RECOMMENDED OPERATING CONDITIONS**

| Symbol   | Parameter                     | Min          | Max      | Unit             |
|----------|-------------------------------|--------------|----------|------------------|
| $V_{CC}$ | Supply Voltage                | 4.5          | 5.5      | V                |
| $I_{FL}$ | Input Current, Low Level      | 0            | 250      | $\mu\text{A}$    |
| $I_{FH}$ | Input Current, High Level     | 6.3 (Note 3) | 20.0     | mA               |
| $V_{EL}$ | Enable Voltage, Low Level     | 0            | 0.8      | V                |
| $V_{EH}$ | Enable Voltage, High Level    | 2.0          | $V_{CC}$ | V                |
| $T_A$    | Ambient Operating Temperature | -40          | +85      | $^\circ\text{C}$ |
| N        | Fan Out (TTL Load)            | -            | 8        |                  |

Functional operation above the stresses listed in the Recommended Operating Ranges is not implied. Extended exposure to stresses beyond the Recommended Operating Ranges limits may affect device reliability.

3. 6.3 mA is a guard banded value which allows for at least 20% CTR degradation. Initial input current threshold value is 5.0 mA or less.

# Single-Channel: 6N137M, HCPL2601M, HCPL2611M Dual-Channel: HCPL2630M, HCPL2631M

## ELECTRICAL CHARACTERISTICS

| Symbol | Parameter | Test Conditions | Device | Min | Typ | Max | Unit |
|--------|-----------|-----------------|--------|-----|-----|-----|------|
|--------|-----------|-----------------|--------|-----|-----|-----|------|

**INDIVIDUAL COMPONENT CHARACTERISTICS** ( $V_{CC} = 5.5\text{ V}$ ,  $T_A = 0^\circ\text{C}$  to  $70^\circ\text{C}$  unless otherwise specified)

| EMITTER                   |  |   |                |     |      |      |                      |
|---------------------------|--|---|----------------|-----|------|------|----------------------|
| $V_F$                     | Input Forward Voltage                      | $I_F = 10\text{ mA}$ , $T_A = 25^\circ\text{C}$                   | All            | -   | 1.45 | 1.70 | V                    |
|                           |  | $I_F = 10\text{ mA}$  |                | -   | -    | 1.80 |                      |
| $B_{VR}$                  | Input Reverse Breakdown Voltage            | $I_R = 10\ \mu\text{A}$   | All            | 5.0 | -    | -    | V                    |
| $C_{IN}$                  | Input Capacitance                          | $V_F = 0$ , $f = 1\text{ MHz}$                                    | All            | -   | 60   | -    | pF                   |
| $\Delta V_F / \Delta T_A$ | Temperature Coefficient of Forward Voltage | $I_F = 10\text{ mA}$  | All            | -   | -1.4 | -    | mV/ $^\circ\text{C}$ |
| DETECTOR                  |  |   |                |     |      |      |                      |
| $I_{OCL}$                 | Logic Low Supply Current                   | $I_F = 10\text{ mA}$ , $V_O = \text{Open}$ , $V_E = 0.5\text{ V}$ | Single Channel | -   | 8    | 13   | mA                   |
|                           |  | $I_{F1} = I_{F2} = 10\text{ mA}$ , $V_O = \text{Open}$            | Dual Channel   | -   | 14   | 21   |                      |
| $I_{OCH}$                 | Logic High Supply Current                  | $I_F = 0\text{ mA}$ , $V_O = \text{Open}$ , $V_E = 0.5\text{ V}$  | Single Channel | -   | 6    | 10   | mA                   |
|                           |  | $I_F = 0\text{ mA}$ , $V_O = \text{Open}$                         | Dual Channel   | -   | 10   | 15   |                      |
| $I_{EL}$                  | Low Level Enable Current                   | $V_E = 0.5\text{ V}$  | Single Channel | -   | -0.7 | -1.6 | mA                   |
| $I_{EH}$                  | High Level Enable Current                  | $V_E = 2.0\text{ V}$  | Single Channel | -   | -0.5 | -1.6 | mA                   |
| $V_{EL}$                  | Low Level Enable Voltage                   | $I_F = 10\text{ mA}$ (Note 4)                                     | Single Channel | -   | -    | 0.8  | V                    |
| $V_{EH}$                  | High Level Enable Voltage                  | $I_F = 10\text{ mA}$  | Single Channel | 2.0 | -    | -    | V                    |

**TRANSFER CHARACTERISTICS** ( $V_{CC} = 5.5\text{ V}$ ,  $T_A = -40^\circ\text{C}$  to  $+85^\circ\text{C}$  unless otherwise specified)

|          |                           |  |     |   |     |     |               |
|----------|---------------------------|--|-----|---|-----|-----|---------------|
| $I_{FT}$ | Input Threshold Current   | $V_O = 0.6\text{ V}$ , $V_E = 2.0\text{ V}$ , $I_{OL} = 13\text{ mA}$  | All | - | 3   | 5   | mA            |
| $I_{OH}$ | HIGH Level Output Current | $V_O = 5.5\text{ V}$ , $I_F = 250\ \mu\text{A}$ , $V_E = 2.0\text{ V}$ | All | - | -   | 100 | $\mu\text{A}$ |
| $V_{OL}$ | LOW Level Output Voltage  | $I_F = 5\text{ mA}$ , $V_E = 2.0\text{ V}$ , $I_{OL} = 13\text{ mA}$   | All | - | 0.4 | 0.6 | V             |

**SWITCHING CHARACTERISTICS** ( $V_{CC} = 5\text{ V}$ ,  $I_F = 7.5\text{ mA}$ ,  $T_A = -40^\circ\text{C}$  to  $+85^\circ\text{C}$  unless otherwise specified)

|                       |  |   |                      |        |        |     |                  |
|-----------------------|--|---|----------------------|--------|--------|-----|------------------|
| $t_{PHL}$             | Propagation Delay Time to Logic LOW                | $R_L = 350\ \Omega$ , $C_L = 15\text{ pF}$ , $T_A = 25^\circ\text{C}$ (Note 5) (Figure 23)                                  | All                  | 25     | 40     | 75  | ns               |
|                       |  | $R_L = 350\ \Omega$ , $C_L = 15\text{ pF}$ (Note 5) (Figure 23)   |                      | -      | -      | 100 |                  |
| $t_{PLH}$             | Propagation Delay Time to Logic HIGH               | $R_L = 350\ \Omega$ , $C_L = 15\text{ pF}$ , $T_A = 25^\circ\text{C}$ (Note 6) (Figure 23)                                  | All                  | 20     | 40     | 75  | ns               |
|                       |  | $R_L = 350\ \Omega$ , $C_L = 15\text{ pF}$ (Note 6) (Figure 23)   |                      | -      | -      | 100 |                  |
| $ t_{PHL} - t_{PLH} $ | Pulse Width Distortion                             | $R_L = 350\ \Omega$ , $C_L = 15\text{ pF}$ (Figure 23)  | All                  | -      | 1      | 35  | ns               |
| $t_R$                 | Output Rise Time (10% to 90%)                      | $R_L = 350\ \Omega$ , $C_L = 15\text{ pF}$ (Note 7) (Figure 23)   | All                  | -      | 30     | -   | ns               |
| $t_F$                 | Output Fall Time (90% to 10%)                      | $R_L = 350\ \Omega$ , $C_L = 15\text{ pF}$ (Note 8) (Figure 23)   | All                  | -      | 10     | -   | ns               |
| $t_{EHL}$             | Enable Propagation Delay Time to Output LOW Level  | $V_{EH} = 3.5\text{ V}$ , $R_L = 350\ \Omega$ , $C_L = 15\text{ pF}$ (Note 9) (Figure 24)                                   | Single Channel       | -      | 15     | -   | ns               |
| $t_{ELH}$             | Enable Propagation Delay Time to Output HIGH Level | $V_{EH} = 3.5\text{ V}$ , $R_L = 350\ \Omega$ , $C_L = 15\text{ pF}$ (Note 10) (Figure 24)                                  | Single Channel       | -      | 15     | -   | ns               |
| $ CM_H $              | Common Mode Transient Immunity at Logic High       | $I_F = 0\text{ mA}$ , $V_{CM} = 50\text{ V}_{PEAK}$ , $R_L = 350\ \Omega$ , $T_A = 25^\circ\text{C}$ (Note 11) (Figure 25)  | 6N137M, HCPL2630M    | -      | 10,000 | -   | V/ $\mu\text{s}$ |
|                       |  |   | HCPL2601M, HCPL2631M | 5000   | 10,000 | -   |                  |
|                       |  | $I_F = 0\text{ mA}$ , $V_{CM} = 400\text{ V}_{PEAK}$ , $R_L = 350\ \Omega$ , $T_A = 25^\circ\text{C}$ (Note 11) (Figure 25) | HCPL2611M            | 10,000 | 15,000 | -   |                  |

# Single-Channel: 6N137M, HCPL2601M, HCPL2611M Dual-Channel: HCPL2630M, HCPL2631M

## ELECTRICAL CHARACTERISTICS (continued)

| Symbol  | Parameter                                   | Test Conditions  | Device                  | Min    | Typ    | Max | Unit             |
|---|---|--|-------------------------|--------|--------|-----|------------------|
| <b>SWITCHING CHARACTERISTICS</b> ( $V_{CC} = 5\text{ V}$ , $I_F = 7.5\text{ mA}$ , $T_A = -40^\circ\text{C}$ to $+85^\circ\text{C}$ unless otherwise specified) |   |  |                         |        |        |     |                  |
| CM <sub>L</sub>   | Common Mode Transient Immunity at Logic Low | $V_{CM} = 50\text{ V}_{PEAK}$ , $R_L = 350\ \Omega$ ,<br>$T_A = 25^\circ\text{C}$ (Note 11) (Figure 25)  | 6N137M,<br>HCPL2630M    | –      | 10,000 | –   | V/ $\mu\text{s}$ |
|   |   |  | HCPL2601M,<br>HCPL2631M | 5000   | 10,000 | –   |                  |
|   |   | $V_{CM} = 400\text{ V}_{PEAK}$ , $R_L = 350\ \Omega$ ,<br>$T_A = 25^\circ\text{C}$ (Note 11) (Figure 25) | HCPL2611M               | 10,000 | 15,000 | –   |                  |

## ISOLATION CHARACTERISTICS ( $T_A = 25^\circ\text{C}$ , unless otherwise noted)

|           |   |  |     |       |           |     |               |
|-----------|---|--|-----|-------|-----------|-----|---------------|
| $V_{ISO}$ | Withstand Insulation Test Voltage       | Relative Humidity $\leq 50\%$ ,<br>$I_{I-O} \leq 10\ \mu\text{A}$ , $t = 1\text{ min}$ , $f = 50\text{ Hz}$<br>(Note 12) (Note 13) | All | 5,000 | –         | –   | $VAC_{RMS}$   |
| $R_{I-O}$ | Resistance (Input to Output)            | $V_{I-O} = 500\text{ V}_{DC}$ (Note 12)  | All | –     | $10^{11}$ | –   | $\Omega$      |
| $C_{I-O}$ | Capacitance (Input to Output)           | $f = 1\text{ MHz}$ , $V_{I-O} = 0\text{ V}_{DC}$ (Note 12)   | All | –     | 1         | –   | pF            |
| $I_{I-O}$ | Input-Output Insulation Leakage Current | Relative Humidity $\leq 45\%$ ,<br>$V_{I-I} = 3000\text{ V}_{DC}$ , $t = 5\text{ s}$ (Note 12)                                     | All | –     | –         | 1.0 | $\mu\text{A}$ |

Product parametric performance is indicated in the Electrical Characteristics for the listed test conditions, unless otherwise noted. Product performance may not be indicated by the Electrical Characteristics if operated under different conditions.

4. Enable Input – No pull up resistor required as the device has an internal pull up resistor.
5.  $t_{PHL}$  – Propagation delay is measured from the 3.75 mA level on the LOW to HIGH transition of the input current pulse to the 1.5 V level on the HIGH to LOW transition of the output voltage pulse.
6.  $t_{PLH}$  – Propagation delay is measured from the 3.75 mA level on the HIGH to LOW transition of the input current pulse to the 1.5 V level on the LOW to HIGH transition of the output voltage pulse.
7.  $t_R$  – Rise time is measured from the 10% to the 90% levels on the LOW to HIGH transition of the output pulse.
8.  $t_F$  – Fall time is measured from the 90% to the 10% levels on the HIGH to LOW transition of the output pulse.
9.  $t_{EHL}$  – Enable input propagation delay is measured from the 1.5 V level on the LOW to HIGH transition of the input voltage pulse to the 1.5 V level on the HIGH to LOW transition of the output voltage pulse.
10.  $t_{ELH}$  – Enable input propagation delay is measured from the 1.5 V level on the HIGH to LOW transition of the input voltage pulse to the 1.5 V level on the LOW to HIGH transition of the output voltage pulse.
11. Common mode transient immunity in logic high level is the maximum tolerable (positive)  $dV_{cm}/dt$  on the leading edge of the common mode pulse signal,  $V_{CM}$ , to assure that the output will remain in a logic high state (i.e.,  $V_O > 2.0\text{ V}$ ). Common mode transient immunity in logic low level is the maximum tolerable (negative)  $dV_{cm}/dt$  on the trailing edge of the common mode pulse signal,  $V_{CM}$ , to assure that the output will remain in a logic low state (i.e.,  $V_O < 0.8\text{ V}$ ).
12. Device is considered a two terminal device: pins 1, 2, 3 and 4 are shorted together and pins 5, 6, 7 and 8 are shorted together.
13. 5000  $VAC_{RMS}$  for 1 minute duration is equivalent to 6000  $VAC_{RMS}$  for 1 second duration

# Single-Channel: 6N137M, HCPL2601M, HCPL2611M Dual-Channel: HCPL2630M, HCPL2631M

## TYPICAL PERFORMANCE CURVES

(For Single-Channel Devices: 6N137M, HCPL2601M, and HCPL2611M)

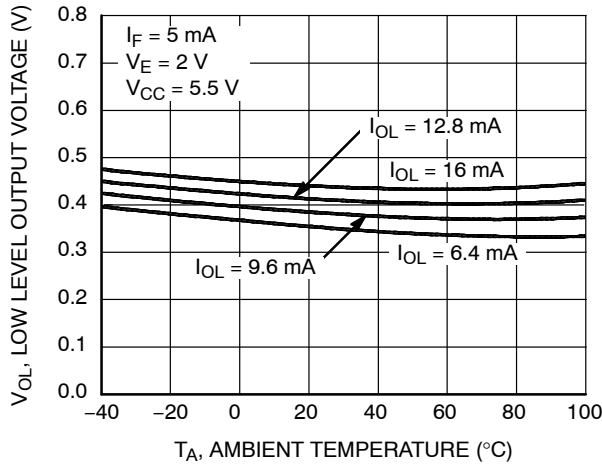

**Figure 2. Low Level Output Voltage vs. Ambient Temperature**

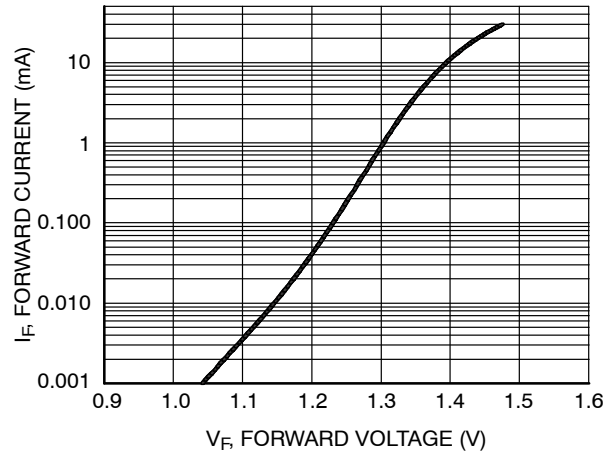

**Figure 3. Input Diode Forward Voltage vs. Forward Current**

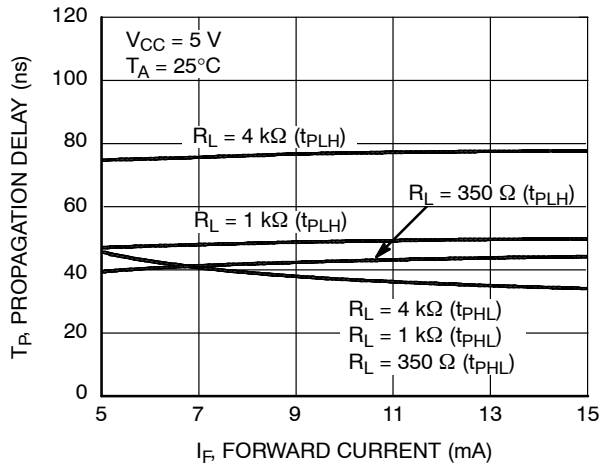

**Figure 4. Switching Time vs. Forward Current**

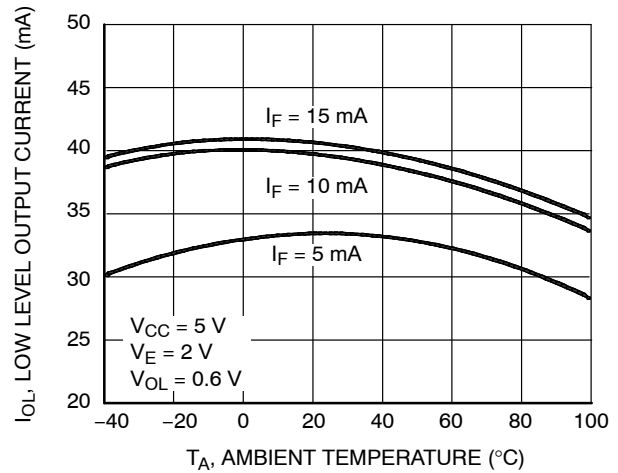

**Figure 5. Low Level Output vs. Ambient Temperature**



**Figure 6. Input Threshold Current vs. Ambient Temperature**

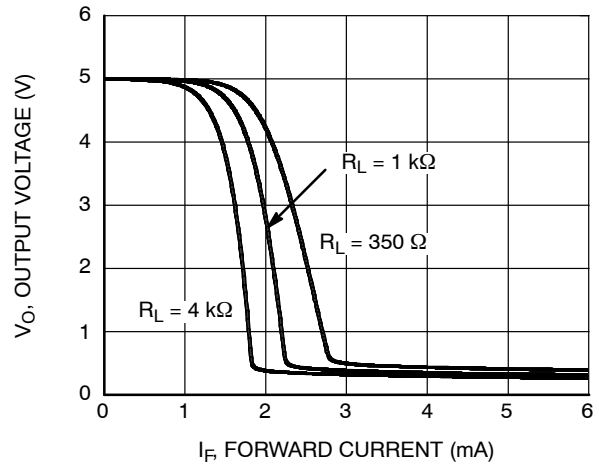
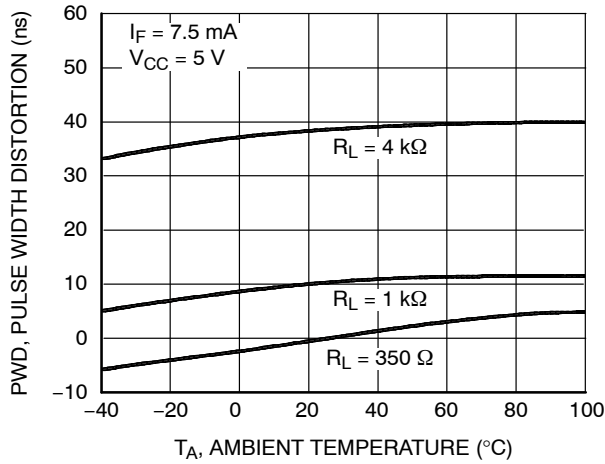

**Figure 7. Output Voltage vs. Input Forward Current**

# Single-Channel: 6N137M, HCPL2601M, HCPL2611M Dual-Channel: HCPL2630M, HCPL2631M

## TYPICAL PERFORMANCE CURVES (Continued)

(For Single-Channel Devices: 6N137M, HCPL2601M, HCPL2611M)



**Figure 8. Pulse Width Distortion vs. Temperature**

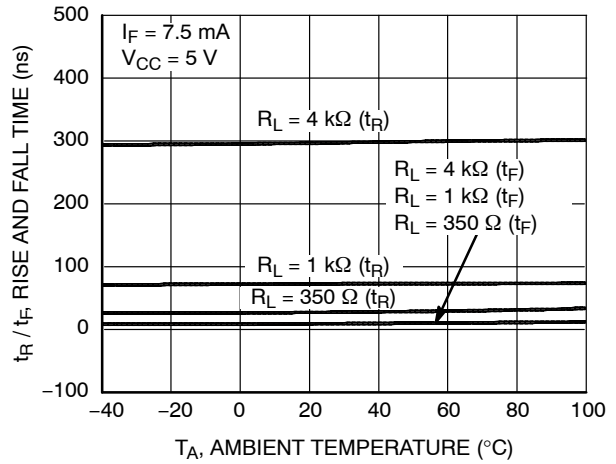

**Figure 9. Rise and Fall Time vs. Temperature**



**Figure 10. Enable Propagation Delay vs. Temperature**



**Figure 11. Switching Time vs. Temperature**



**Figure 12. High Level Output Current vs. Temperature**



**Single-Channel: 6N137M, HCPL2601M, HCPL2611M Dual-Channel: HCPL2630M, HCPL2631M**

**TYPICAL PERFORMANCE CURVES (Continued)**

(For Dual-Channel Devices: HCPL2630M and HCPL2631M)

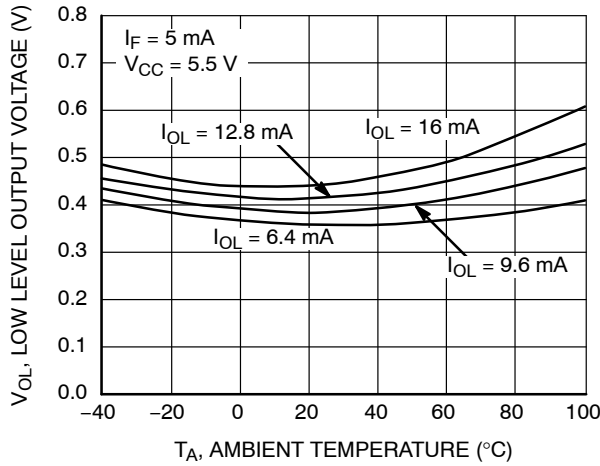

**Figure 13. Low Level Output Voltage vs. Ambient Temperature**

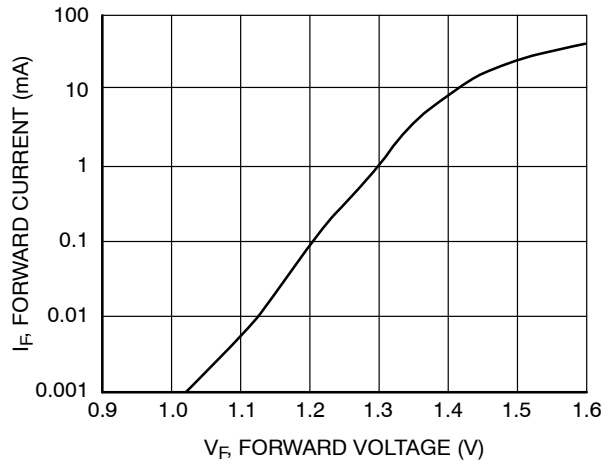

**Figure 14. Input Diode Forward Voltage vs. Forward Current**

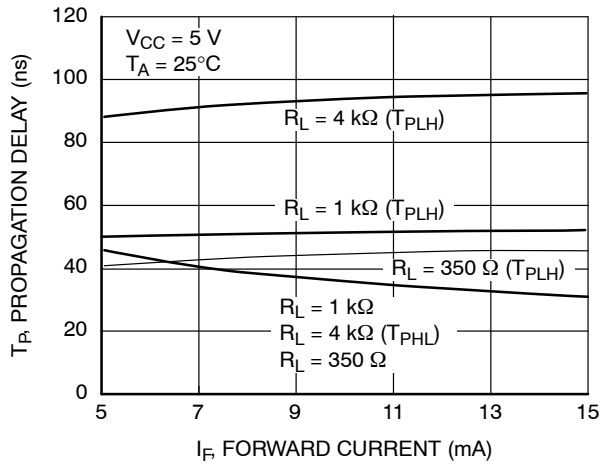

**Figure 15. Switching Time vs. Forward Current**

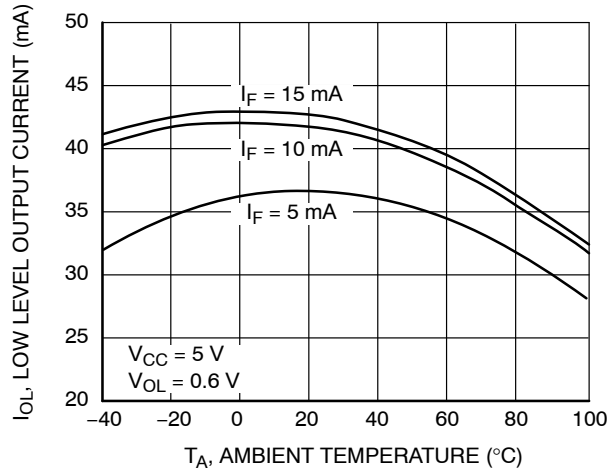

**Figure 16. Low Level Output Current vs. Ambient Temperature**

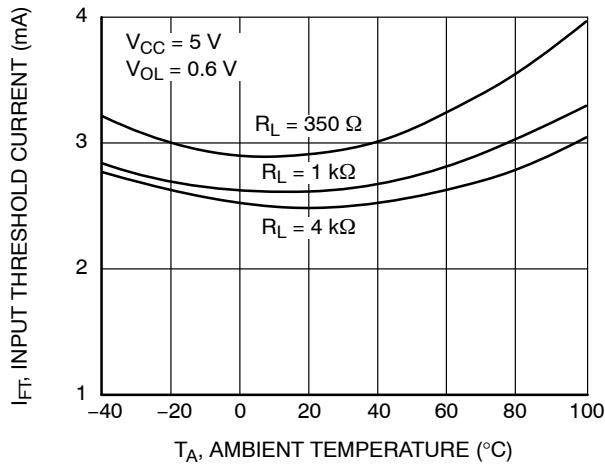

**Figure 17. Input Threshold Current vs. Ambient Temperature**

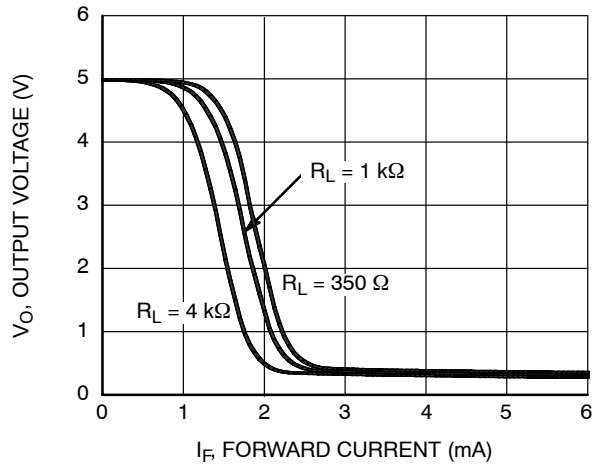

**Figure 18. Output Voltage vs. Input Forward Current**

Single-Channel: 6N137M, HCPL2601M, HCPL2611M Dual-Channel: HCPL2630M, HCPL2631M

TYPICAL PERFORMANCE CURVES (Continued)

(For Dual-Channel Devices: HCPL2630M and HCPL2631M)

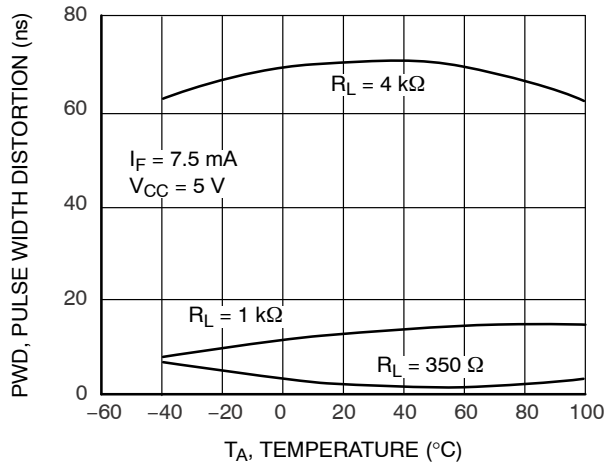

Figure 19. Pulse Width Distortion vs. Temperature

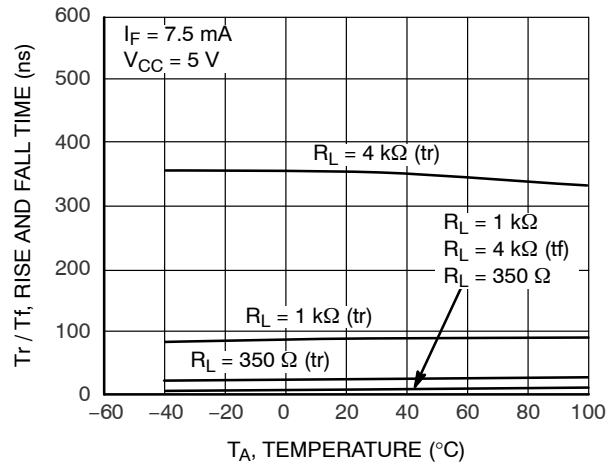

Figure 20. Rise and Fall Time vs. Temperature

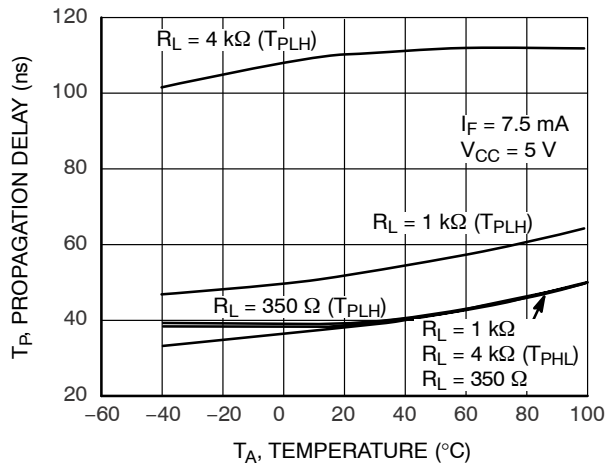

Figure 21. Switching Time vs. Temperature

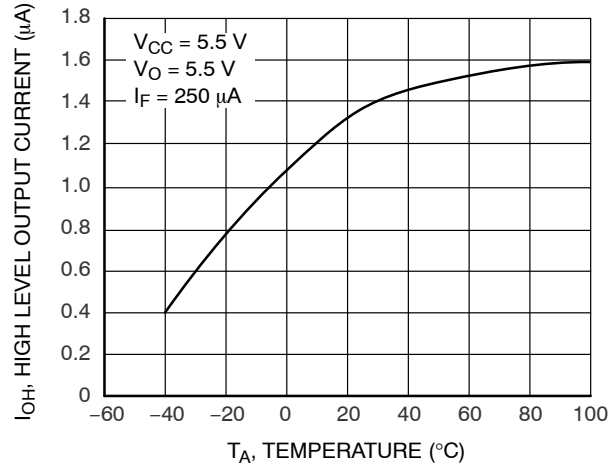

Figure 22. High Level Output Current vs. Temperature

Single-Channel: 6N137M, HCPL2601M, HCPL2611M Dual-Channel: HCPL2630M, HCPL2631M

TEST CIRCUITS



Figure 23. Test Circuit and Waveforms for  $t_{PLH}$ ,  $t_{PHL}$ ,  $t_r$  and  $t_f$

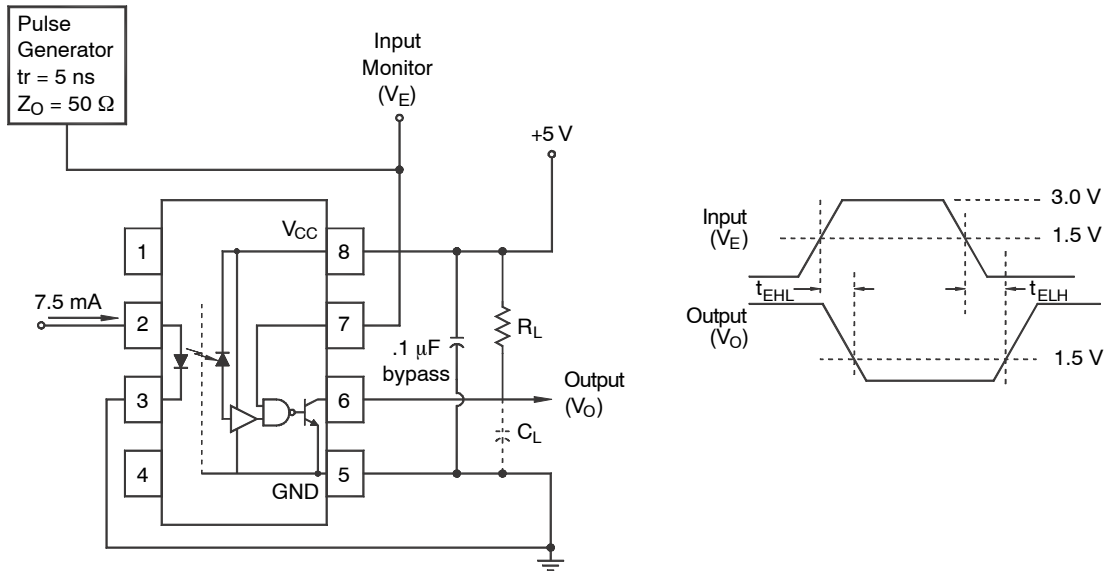

Figure 24. Test Circuit  $t_{EHL}$  and  $t_{ELH}$

Single-Channel: 6N137M, HCPL2601M, HCPL2611M Dual-Channel: HCPL2630M, HCPL2631M

TEST CIRCUITS (Continued)

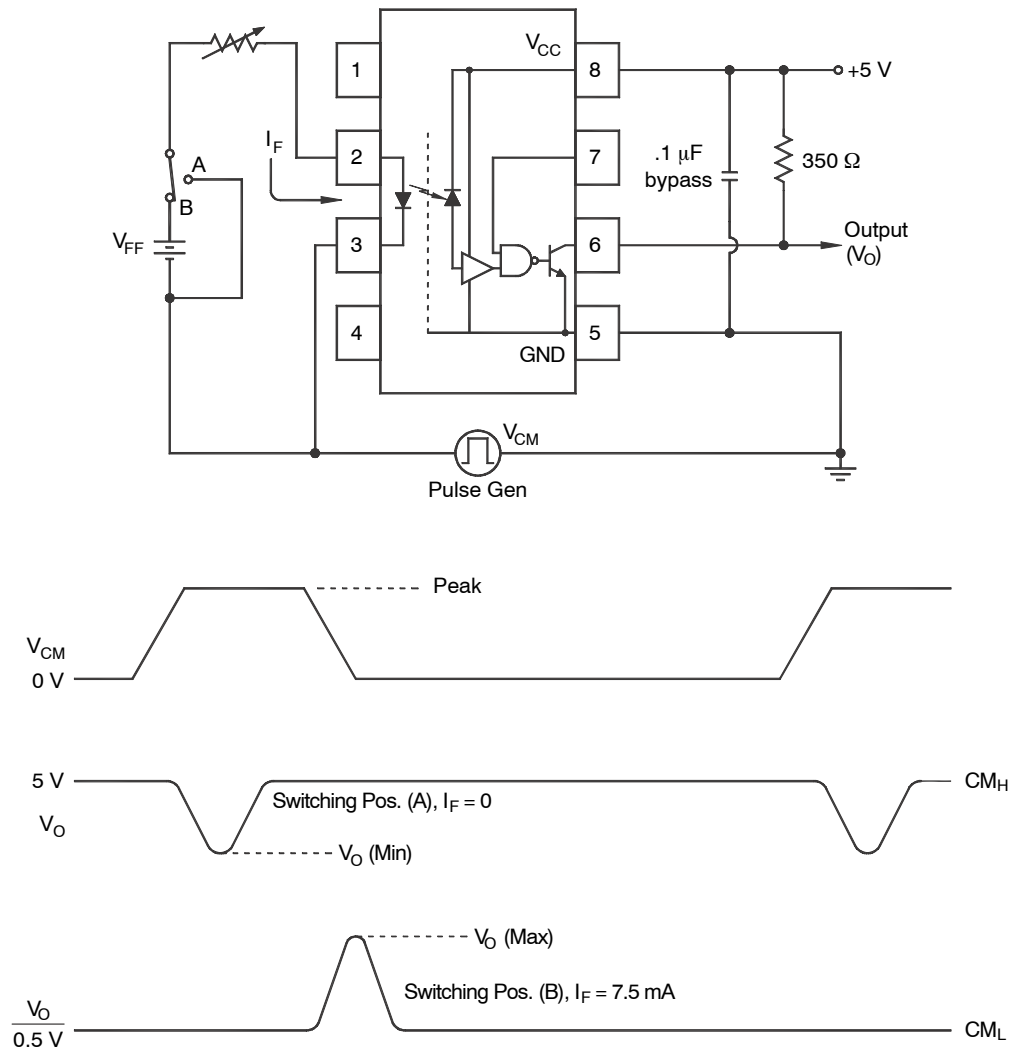
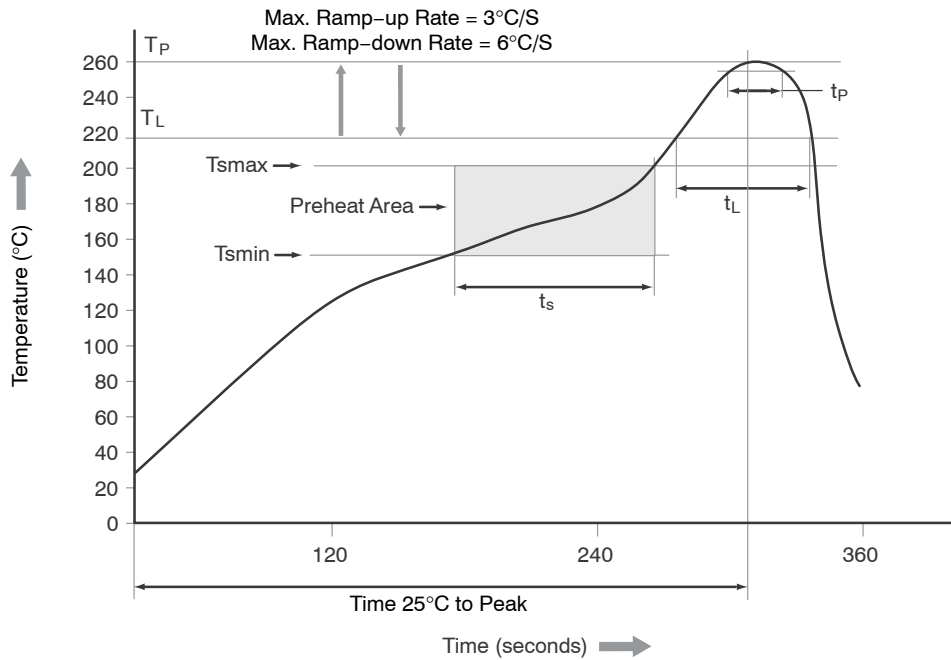

Figure 25. Test Circuit Common Mode Transient Immunity

Single-Channel: 6N137M, HCPL2601M, HCPL2611M Dual-Channel: HCPL2630M, HCPL2631M

REFLOW PROFILE



| Profile Feature   | Pb-Free Assembly Profile |
|---|--------------------------|
| Temperature Minimum (T <sub>smin</sub> )                              | 150°C                    |
| Temperature Maximum (T <sub>smax</sub> )                              | 200°C                    |
| Time (t <sub>s</sub> ) from (T <sub>smin</sub> to T <sub>smax</sub> ) | 60 to 120 s              |
| Ramp-up Rate (t <sub>L</sub> to t <sub>p</sub> )                      | 3°C/second maximum       |
| Liquidous Temperature (T <sub>L</sub> )                               | 217°C                    |
| Time (t <sub>L</sub> ) Maintained Above (T <sub>L</sub> )             | 60 to 150 s              |
| Peak Body Package Temperature   | 260°C +0°C / -5°C        |
| Time (t <sub>p</sub> ) within 5°C of 260°C                            | 30 s                     |
| Ramp-down Rate (T <sub>P</sub> to T <sub>L</sub> )                    | 6°C/s maximum            |
| Time 25°C to Peak Temperature   | 8 minutes maximum        |

Figure 26. Reflow Profile

**Single-Channel: 6N137M, HCPL2601M, HCPL2611M Dual-Channel: HCPL2630M,  
HCPL2631M**

**ORDERING INFORMATION** (Note 14)

| Part Number | Package  | Shipping <sup>†</sup> |
|-------------|--|-----------------------|
| 6N137M      | PDIP8 9.655x6.6, 2.54P, CASE 646CQ<br>DIP8-Pin<br>(Pb-Free)  | 50 Units / Tube       |
| 6N137SM     | PDIP8 GW, CASE 709AC<br>SMT 8-Pin (Lead Bend)<br>(Pb-Free)   | 50 Units / Tube       |
| 6N137SDM    | PDIP8 GW, CASE 709AC<br>SMT 8-Pin (Lead Bend)<br>(Pb-Free)   | 1000 / Tape & Reel    |
| 6N137VM     | PDIP8 9.655x6.6, 2.54P, CASE 646CQ<br>DIP 8-Pin, DIN EN/IEC 60747-5-5 Option<br>(Pb-Free)                  | 50 Units / Tube       |
| 6N137SVM    | PDIP8 GW, CASE 709AC<br>SMT 8-Pin (Lead Bend), DIN EN/IEC 60747-5-5 Option<br>(Pb-Free)                    | 50 Units / Tube       |
| 6N137SDVM   | PDIP8 GW, CASE 709AC<br>SMT 8-Pin (Lead Bend), DIN EN/IEC 60747-5-5 Option<br>(Pb-Free)                    | 1000 / Tape & Reel    |
| 6N137TVM    | PDIP8 6.6x3.81, 2.54P, CASE 646BW<br>DIP 8-Pin, 0.4" Lead Spacing, DIN EN/IEC60747-5-5 Option<br>(Pb-Free) | 50 Units / Tube       |
| 6N137TSVM   | PDIP8 GW, CASE 709AD<br>SMT 8-Pin, 0.4" Lead Spacing, DIN EN/IEC60747-5-5 Option<br>(Pb-Free)              | 50 Units / Tube       |
| 6N137TSR2VM | PDIP8 GW, CASE 709AD<br>SMT 8-Pin, 0.4" Lead Spacing, DIN EN/IEC60747-5-5 Option<br>(Pb-Free)              | 1000 / Tape & Reel    |

<sup>†</sup>For information on tape and reel specifications, including part orientation and tape sizes, please refer to our Tape and Reel Packaging Specifications Brochure, BRD8011/D.

14. The product orderable part number system listed in this table also applies to the HCPL2601M, HCPL2611M, HCPL2630M and HCPL2631M product families.

**MECHANICAL CASE OUTLINE**  
**PACKAGE DIMENSIONS**

ON Semiconductor®



**PDIP8 6.6x3.81, 2.54P**  
CASE 646BW  
ISSUE O

DATE 31 JUL 2016



- NOTES:  
A) NO STANDARD APPLIES TO THIS PACKAGE  
B) ALL DIMENSIONS ARE IN MILLIMETERS.  
C) DIMENSIONS ARE EXCLUSIVE OF BURRS, MOLD FLASH, AND TIE BAR EXTRUSION

|                         |                              |  |
|-------------------------|------------------------------|--|
| <b>DOCUMENT NUMBER:</b> | <b>98AON13445G</b>           | Electronic versions are uncontrolled except when accessed directly from the Document Repository. Printed versions are uncontrolled except when stamped "CONTROLLED COPY" in red. |
| <b>DESCRIPTION:</b>     | <b>PDIP8 6.6X3.81, 2.54P</b> | <b>PAGE 1 OF 1</b>   |

ON Semiconductor and are trademarks of Semiconductor Components Industries, LLC dba ON Semiconductor or its subsidiaries in the United States and/or other countries. ON Semiconductor reserves the right to make changes without further notice to any products herein. ON Semiconductor makes no warranty, representation or guarantee regarding the suitability of its products for any particular purpose, nor does ON Semiconductor assume any liability arising out of the application or use of any product or circuit, and specifically disclaims any and all liability, including without limitation special, consequential or incidental damages. ON Semiconductor does not convey any license under its patent rights nor the rights of others.

# MECHANICAL CASE OUTLINE

## PACKAGE DIMENSIONS

ON Semiconductor®



PDIP8 9.655x6.6, 2.54P  
CASE 646CQ  
ISSUE O

DATE 18 SEP 2017

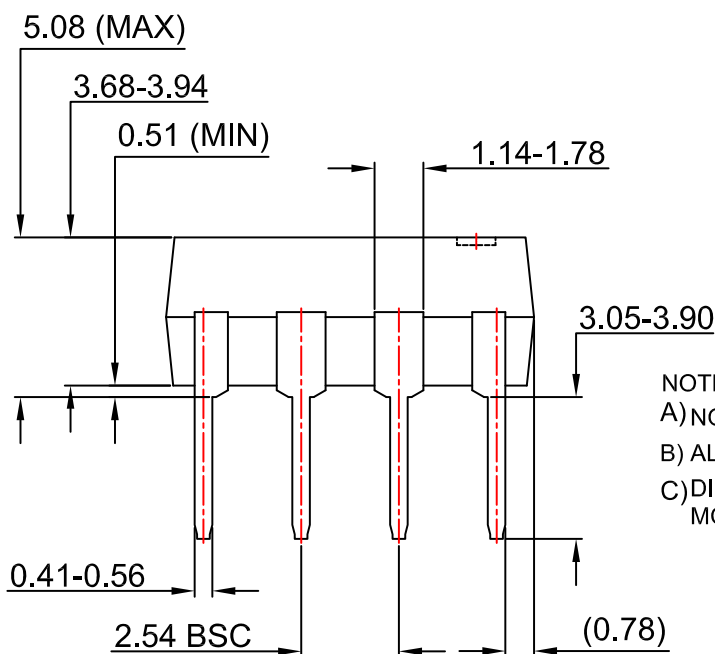

NOTES:  
A) NO STANDARD APPLIES TO THIS PACKAGE  
B) ALL DIMENSIONS ARE IN MILLIMETERS.  
C) DIMENSIONS ARE EXCLUSIVE OF BURRS, MOLD FLASH, AND TIE BAR EXTRUSION

|                         |                               |  |
|-------------------------|-------------------------------|--|
| <b>DOCUMENT NUMBER:</b> | <b>98AON13446G</b>            | Electronic versions are uncontrolled except when accessed directly from the Document Repository. Printed versions are uncontrolled except when stamped "CONTROLLED COPY" in red. |
| <b>DESCRIPTION:</b>     | <b>PDIP8 9.655X6.6, 2.54P</b> | <b>PAGE 1 OF 1</b>   |

ON Semiconductor and are trademarks of Semiconductor Components Industries, LLC dba ON Semiconductor or its subsidiaries in the United States and/or other countries. ON Semiconductor reserves the right to make changes without further notice to any products herein. ON Semiconductor makes no warranty, representation or guarantee regarding the suitability of its products for any particular purpose, nor does ON Semiconductor assume any liability arising out of the application or use of any product or circuit, and specifically disclaims any and all liability, including without limitation special, consequential or incidental damages. ON Semiconductor does not convey any license under its patent rights nor the rights of others.



# MECHANICAL CASE OUTLINE

## PACKAGE DIMENSIONS

ON Semiconductor®



**PDIP8 GW**  
CASE 709AC  
ISSUE O

DATE 31 JUL 2016



LAND PATTERN RECOMMENDATION

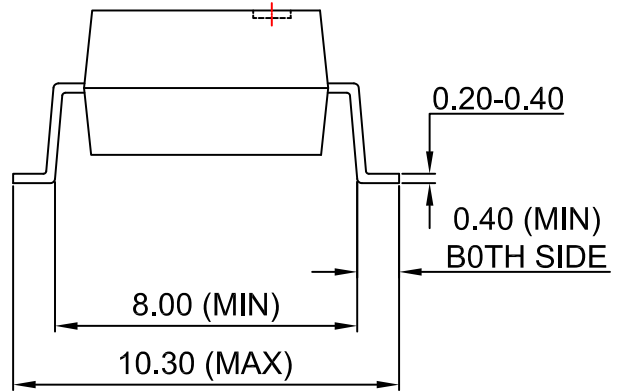

**NOTES:**

- A) NO STANDARD APPLIES TO THIS PACKAGE
- B) ALL DIMENSIONS ARE IN MILLIMETERS.
- C) DIMENSIONS ARE EXCLUSIVE OF BURRS, MOLD FLASH, AND TIE BAR EXTRUSION

|                         |                    |  |
|-------------------------|--------------------|--|
| <b>DOCUMENT NUMBER:</b> | <b>98AON13447G</b> | Electronic versions are uncontrolled except when accessed directly from the Document Repository. Printed versions are uncontrolled except when stamped "CONTROLLED COPY" in red. |
| <b>DESCRIPTION:</b>     | <b>PDIP8 GW</b>    | <b>PAGE 1 OF 1</b>   |

ON Semiconductor and are trademarks of Semiconductor Components Industries, LLC dba ON Semiconductor or its subsidiaries in the United States and/or other countries. ON Semiconductor reserves the right to make changes without further notice to any products herein. ON Semiconductor makes no warranty, representation or guarantee regarding the suitability of its products for any particular purpose, nor does ON Semiconductor assume any liability arising out of the application or use of any product or circuit, and specifically disclaims any and all liability, including without limitation special, consequential or incidental damages. ON Semiconductor does not convey any license under its patent rights nor the rights of others.

**onsemi**, **Onsemi**, and other names, marks, and brands are registered and/or common law trademarks of Semiconductor Components Industries, LLC dba "**onsemi**" or its affiliates and/or subsidiaries in the United States and/or other countries. **onsemi** owns the rights to a number of patents, trademarks, copyrights, trade secrets, and other intellectual property. A listing of **onsemi**'s product/patent coverage may be accessed at [www.onsemi.com/site/pdf/Patent-Marking.pdf](http://www.onsemi.com/site/pdf/Patent-Marking.pdf). **onsemi** reserves the right to make changes at any time to any products or information herein, without notice. The information herein is provided "as-is" and **onsemi** makes no warranty, representation or guarantee regarding the accuracy of the information, product features, availability, functionality, or suitability of its products for any particular purpose, nor does **onsemi** assume any liability arising out of the application or use of any product or circuit, and specifically disclaims any and all liability, including without limitation special, consequential or incidental damages. Buyer is responsible for its products and applications using **onsemi** products, including compliance with all laws, regulations and safety requirements or standards, regardless of any support or applications information provided by **onsemi**. "Typical" parameters which may be provided in **onsemi** data sheets and/or specifications can and do vary in different applications and actual performance may vary over time. All operating parameters, including "Typicals" must be validated for each customer application by customer's technical experts. **onsemi** does not convey any license under any of its intellectual property rights nor the rights of others. **onsemi** products are not designed, intended, or authorized for use as a critical component in life support systems or any FDA Class 3 medical devices or medical devices with a same or similar classification in a foreign jurisdiction or any devices intended for implantation in the human body. Should Buyer purchase or use **onsemi** products for any such unintended or unauthorized application, Buyer shall indemnify and hold **onsemi** and its officers, employees, subsidiaries, affiliates, and distributors harmless against all claims, costs, damages, and expenses, and reasonable attorney fees arising out of, directly or indirectly, any claim of personal injury or death associated with such unintended or unauthorized use, even if such claim alleges that **onsemi** was negligent regarding the design or manufacture of the part. **onsemi** is an Equal Opportunity/Affirmative Action Employer. This literature is subject to all applicable copyright laws and is not for resale in any manner.

## ADDITIONAL INFORMATION

### TECHNICAL PUBLICATIONS:

Technical Library: [www.onsemi.com/design/resources/technical-documentation](http://www.onsemi.com/design/resources/technical-documentation)  
onsemi Website: [www.onsemi.com](http://www.onsemi.com)

### ONLINE SUPPORT: [www.onsemi.com/support](http://www.onsemi.com/support)

For additional information, please contact your local Sales Representative at [www.onsemi.com/support/sales](http://www.onsemi.com/support/sales)