

HLMA-KL00 & HLMA-KH00 SunPower Series T-1 (3 mm), High Performance AlInGaP LED Lamps



Data Sheet



Lead (Pb) Free
RoHS 6 fully
compliant



Description

These untinted, non-diffused, solid state lamps utilize the latest absorbing substrate aluminum indium gallium phosphide (AlInGaP) LED technology. These materials have a very high luminous efficiency, capable of producing high light output over a wide range of drive currents. In addition, these LED lamps are at wavelengths ranging from amber to red orange.

Package Dimensions

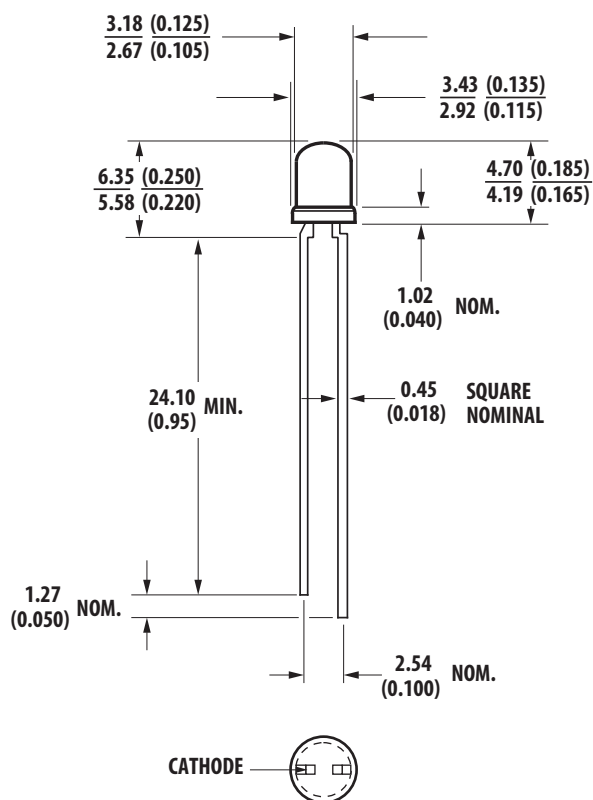

Features

- Outstanding LED Material Efficiency
- High Light Output over a Wide Range of Currents
- Low Electrical Power Dissipation
- Colors:

Amber	590 nm
Red-Orange	615 nm

Applications

- Outdoor Message Boards
- Safety Lighting Equipment
- Signaling Applications
- Emitter for Emitter/Detector Applications
- Changeable Message Signs
- Portable Equipment
- Medical Equipment
- Automotive Lighting
- Alternative to Incandescent Lamps

NOTES:

1. ALL DIMENSIONS ARE IN MILLIMETERS (INCHES).
2. AN EPOXY MENISCUS MAY EXTEND ABOUT 0.8 MM (0.032") DOWN THE LEADS, UNLESS OTHERWISE NOTED.

Device Selection Guide

Part Number	Color	Dominant Wavelength λ_d (nm) Typ	Luminous Intensity Iv (mcd) at 20 mA-Min	Luminous Intensity Iv (mcd) at 20 mA-Max
HLMA-KL00-I0000	Amber	590nm	42.3	-
HLMA-KH00-J0000	Red Orange	615nm	39.6	-

Tolerance for each intensity bin limit is $\pm 15\%$.

Absolute Maximum Ratings at $T_A = 25^\circ\text{C}$

Parameter	Value	Unit
DC Forward Current [1,4,5]	50	mA
Peak Forward Current [2]	200	mA
Time Average Input Power [2]	103	mW
Transient Forward Current [3] (10 ms Pulse)	500	mA
Reverse Voltage ($I_R = 100 \mu\text{A}$)	5	V
Operating Temperature Range	-40 to 100	$^\circ\text{C}$
Storage Temperature	-40 to 100	$^\circ\text{C}$
Junction Temperature	110	$^\circ\text{C}$

Notes:

- Derate linearly as shown in Figure 4.
- Any pulsed operation cannot exceed the Absolute Max Peak Forward Current or the Max Allowable Time Average Power as specified in Figure 5.
- The transient peak current is the maximum nonrecurring peak current the device can withstand without damaging the LED die and wire bonds.
- Drive Currents between 10 mA and 30 mA are recommended for best long term performance.
- Operation at currents below 10 mA is not recommended, please contact your Avago Technologies sales representative.

Optical Characteristics at $T_A = 25^\circ\text{C}$

Part Number	Luminous Intensity I (mcd) @ 20 mA [1]		Peak Wavelength λ (nm)	Color, Dominant Wavelength λ [2] (nm)		Viewing Angle $2\theta^{1/2}$ Degrees [3]	Luminous Efficacy η (lm/w)	Luminous Flux (lm) @20 mA
	Min.	Typ.	Typ.	Min.	Max.	Typ.	η (lm/w)	Typ.
KL00	35	200	592	584.5	597.0	45	480	500
KH00	35	200	621	611.0	623.0	45	263	500

Notes:

- The luminous intensity, Iv, is measured at the mechanical axis of the lamp package. The actual peak of the spatial radiation pattern may not be aligned with this axis.
- The dominant wavelength, λ_d , is derived from the CIE Chromaticity Diagram and represents the color of the device.
- $\theta^{1/2}$ is the off-axis angle where the luminous intensity is 1/2 the peak intensity.

Electrical Characteristics at $T_A = 25^\circ\text{C}$

	Forward Voltage V (Volts) @ I = 20 mA		Reverse Breakdown V (Volts) @ I = 100 μA		Capacitance C (pF) V = 0, f = 1 MHz	Thermal Resistance R ($^\circ\text{C}/\text{W}$)	Speed of Response (ns) Time Constant e^{-t/t_s}
	Typ.	Max.	Min.	Typ.	Typ.		Typ.
KL00	1.9	2.4	5	25	40	290	13
KH00	1.9	2.4	5	25	40	290	13

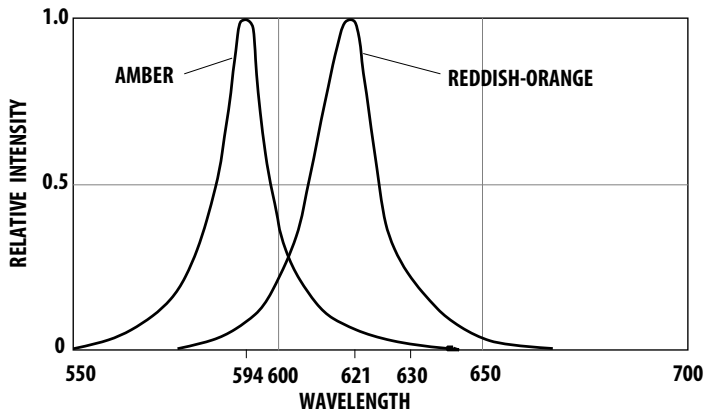

Figure 1. Relative Intensity vs. Wavelength.

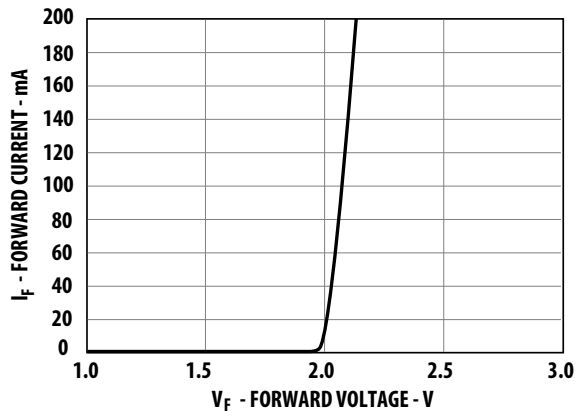

Figure 2. Forward Current vs. Forward Voltage, AS-AlInGaP.

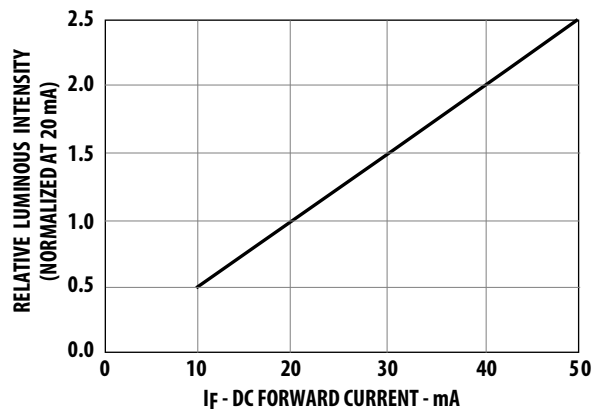

Figure 3. Relative Luminous Intensity vs. Forward Current.

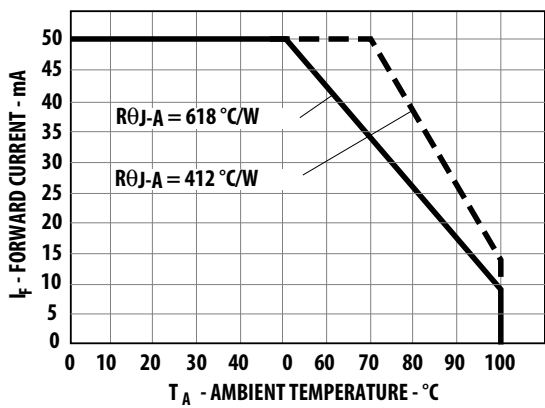

Figure 4. Maximum Forward Current vs. Ambient Temperature. Derating Based on $T_{JMAX} = 110\text{ }^{\circ}\text{C}$.

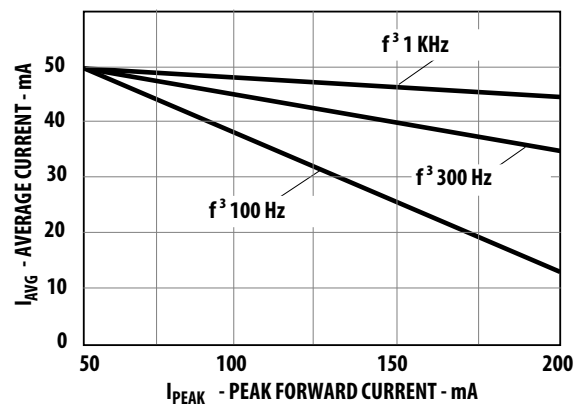

Figure 5. Maximum Average Current vs. Peak Forward Current.

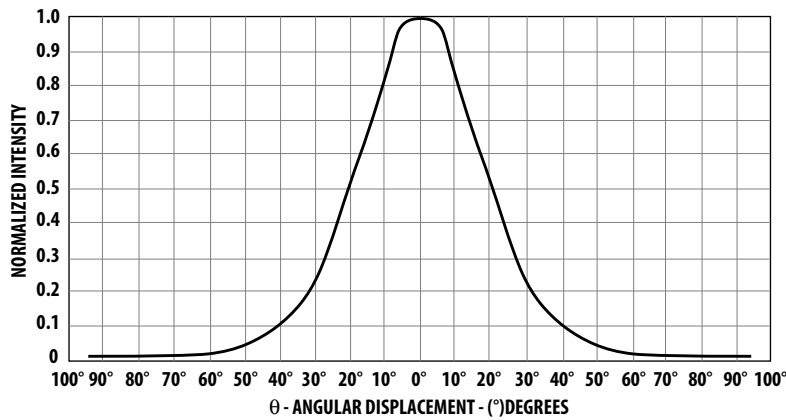

Figure 6. Normalized Luminous Intensity vs. Angular Displacement.

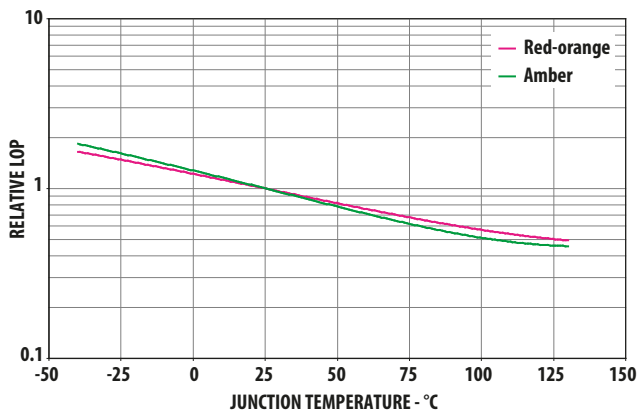

Figure 7. Relative light output vs. junction temperature

Amber Intensity Bin Limits (mcd at 20 mA)

Bin Name	Min.	Max.
I	42.3	67.7
J	67.7	108.2
K	108.2	173.2
L	173.2	250.0
M	250.0	360.0
N	360.0	510.0
O	510.0	800.0
P	800.0	1250.0
Q	1250.0	1800.0

Tolerance for each bin limit is $\pm 15\%$.

Reddish-Orange Intensity Bin Limits (mcd at 20 mA)

Bin Name	Min.	Max.
J	39.6	63.4
K	63.4	101.5
L	101.5	162.4
M	162.4	234.6
N	234.6	340.0
O	340.0	540.0
P	540.0	850.0
Q	850.0	1200.0

Tolerance for each bin limit is $\pm 15\%$.

Amber Color Bin Limits (nm at 20mA)

Bin Name	Min.	Max.
3	584.5	587.0
2	587.0	598.5
4	589.5	592.0
6	592.0	594.5
7	594.5	597.0

Tolerance for each bin limit is $\pm 0.5\text{nm}$.

Precautions:

Lead Forming:

- The leads of an LED lamp may be preformed or cut to length prior to insertion and soldering on PC board.
- For better control, it is recommended to use proper tool to precisely form and cut the leads to applicable length rather than doing it manually.
- If manual lead cutting is necessary, cut the leads after the soldering process. The solder connection forms a mechanical ground which prevents mechanical stress due to lead cutting from traveling into LED package. This is highly recommended for hand solder operation, as the excess lead length also acts as small heat sink.

Soldering and Handling:

- Care must be taken during PCB assembly and soldering process to prevent damage to the LED component.
- LED component may be effectively hand soldered to PCB. However, it is only recommended under unavoidable circumstances such as rework. The closest manual soldering distance of the soldering heat source (soldering iron's tip) to the body is 1.59mm. Soldering the LED using soldering iron tip closer than 1.59mm might damage the LED.



- ESD precaution must be properly applied on the soldering station and personnel to prevent ESD damage to the LED component that is ESD sensitive. Do refer to Avago application note AN 1142 for details. The soldering iron used should have grounded tip to ensure electrostatic charge is properly grounded.
- Recommended soldering condition:

	Wave Soldering [1,2]	Manual Solder Dipping
Pre-heat temperature	105 °C Max.	-
Preheat time	60 sec Max	-
Peak temperature	250 °C Max.	260 °C Max.
Dwell time	3 sec Max.	5 sec Max

Note:

- 1) Above conditions refers to measurement with thermocouple mounted at the bottom of PCB.
 - 2) It is recommended to use only bottom preheaters in order to reduce thermal stress experienced by LED.
- Wave soldering parameters must be set and maintained according to the recommended temperature and dwell time. Customer is advised to perform daily check on the soldering profile to ensure that it is always conforming to recommended soldering conditions.

Note:

1. PCB with different size and design (component density) will have different heat mass (heat capacity). This might cause a change in temperature experienced by the board if same wave soldering setting is used. So, it is recommended to re-calibrate the soldering profile again before loading a new type of PCB.
2. Avago Technologies' high brightness LED are using high efficiency LED die with single wire bond as shown below. Customer is advised to take extra precaution during wave soldering to ensure that the maximum wave temperature does not exceed 250°C and the solder contact time does not exceeding 3sec. Over-stressing the LED during soldering process might cause premature failure to the LED due to delamination.

Avago Technologies LED configuration

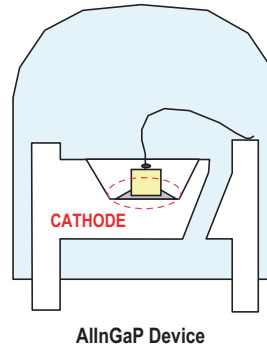

Note: Electrical connection between bottom surface of LED die and the lead frame is achieved through conductive paste.

- Any alignment fixture that is being applied during wave soldering should be loosely fitted and should not apply weight or force on LED. Non metal material is recommended as it will absorb less heat during wave soldering process.
- At elevated temperature, LED is more susceptible to mechanical stress. Therefore, PCB must allowed to cool down to room temperature prior to handling, which includes removal of alignment fixture or pallet.
- If PCB board contains both through hole (TH) LED and other surface mount components, it is recommended that surface mount components be soldered on the top side of the PCB. If surface mount need to be on the bottom side, these components should be soldered using reflow soldering prior to insertion the TH LED.
- Recommended PC board plated through holes (PTH) size for LED component leads.

LED component lead size	Diagonal	Plated through hole diameter
0.45 x 0.45 mm (0.018x 0.018 inch)	0.636 mm (0.025 inch)	0.98 to 1.08 mm (0.039 to 0.043 inch)
0.50 x 0.50 mm (0.020x 0.020 inch)	0.707 mm (0.028 inch)	1.05 to 1.15 mm (0.041 to 0.045 inch)

- Over-sizing the PTH can lead to twisted LED after clinching. On the other hand under sizing the PTH can cause difficulty inserting the TH LED.

Refer to Application Note 5334 for more information about soldering and handling of high brightness TH LED lamps.

Example of Wave Soldering Temperature Profile for TH LED

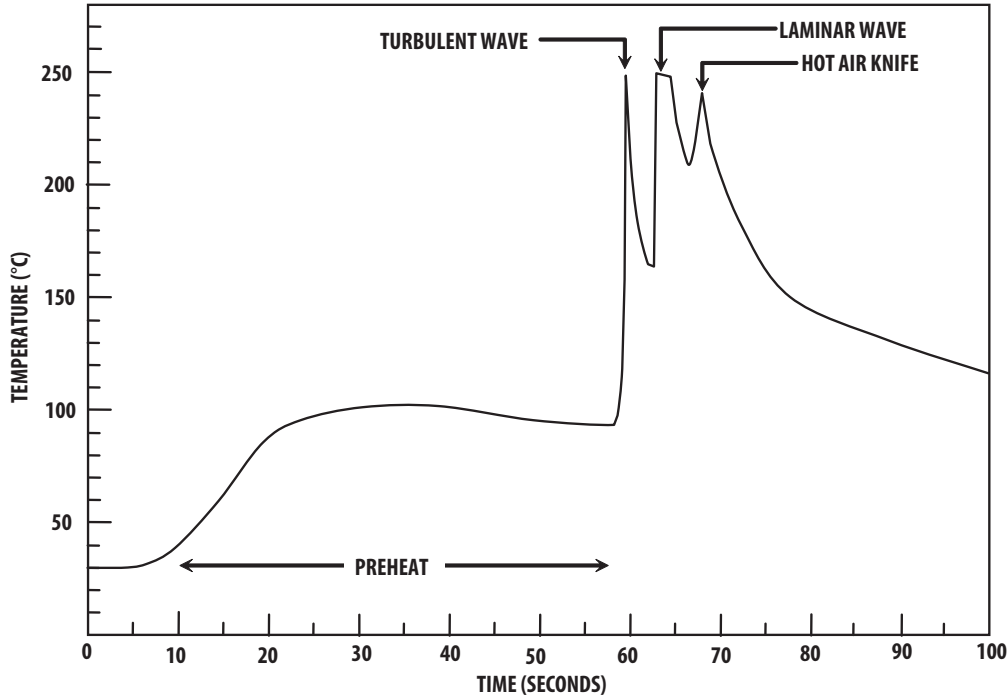

Recommended solder:
 Sn63 (Leaded solder alloy)
 SAC305 (Lead free solder alloy)

Flux: Rosin flux

Solder bath temperature:
 245°C ± 5°C (maximum peak
 temperature = 250°C)

Dwell time: 1.5 sec - 3.0 sec
 (maximum = 3sec)











Note: Allow for board to be
 sufficiently cooled to room
 temperature before exerting
 mechanical force.

Packaging Label

(i) Avago Mother Label: (Available on packaging box of ammo pack and shipping box)

AVAGO TECHNOLOGIES	
(1P) Item: Part Number	STANDARD LABEL LS0002
	RoHS Compliant
(1T) Lot: Lot Number	e3 max temp 250C
	(Q) QTY: Quantity
LPN:	
	CAT: Intensity Bin
(9D)MFG Date: Manufacturing Date	
	BIN: Refer to below information
<hr/>	
(P) Customer Item:	
(V) Vendor ID:	(9D) Date Code: Date Code
DeptID:	Made In: Country of Origin

(ii) Avago Baby Label (Only available on bulk packaging)

		RoHS Compliant e3 max temp 250C
Lamps Baby Label		
(1P) PART #: Part Number		
		
(1T) LOT #: Lot Number		
		
(9D)MFG DATE: Manufacturing Date	QUANTITY: Packing Quantity	
		
C/O: Country of Origin		
Customer P/N:	CAT: Intensity Bin	
		
Supplier Code:	BIN: Refer to below information	
		
	DATECODE: Date Code	
		

Acronyms and Definition:

BIN:

- (i) Color bin only or VF bin only
 (Applicable for part number with color bins but without VF bin OR part number with VF bins and no color bin)
 OR
- (ii) Color bin incorporated with VF Bin
 (Applicable for part number that have both color bin and VF bin)

Example:

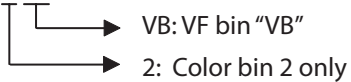
- (i) Color bin only or VF bin only
 BIN: 2 (represent color bin 2 only)
 BIN: VB (represent VF bin "VB" only)
- (ii) Color bin incorporate with VF Bin
 BIN: 2VB

DISCLAIMER: AVAGO'S PRODUCTS AND SOFTWARE ARE NOT SPECIFICALLY DESIGNED, MANUFACTURED OR AUTHORIZED FOR SALE AS PARTS, COMPONENTS OR ASSEMBLIES FOR THE PLANNING, CONSTRUCTION, MAINTENANCE OR DIRECT OPERATION OF A NUCLEAR FACILITY OR FOR USE IN MEDICAL DEVICES OR APPLICATIONS. CUSTOMER IS SOLELY RESPONSIBLE, AND WAIVES ALL RIGHTS TO MAKE CLAIMS AGAINST AVAGO OR ITS SUPPLIERS, FOR ALL LOSS, DAMAGE, EXPENSE OR LIABILITY IN CONNECTION WITH SUCH USE.

For product information and a complete list of distributors, please go to our web site: www.avagotech.com

Avago, Avago Technologies, and the A logo are trademarks of Avago Technologies in the United States and other countries. Data subject to change. Copyright © 2005-2014 Avago Technologies. All rights reserved. Obsoletes AV02-0648EN AV02-1524EN - July 21, 2014

