



**MULTI-INNO TECHNOLOGY CO., LTD.**

# **LCD MODULE SPECIFICATION**

**Model : MI0600AT**

Revision	1.0
Engineering	
Date	
Our Reference	



## Table of Contents

Table of Contents .....	2
Record of Revision.....	3
1 General Specifications .....	4
2 Input/Output Terminals .....	5
3 Absolute Maximum Ratings .....	8
4 Electrical Characteristics.....	9
5 Timing Chart.....	13
6 Optical Characteristics .....	17
7 Environmental / Reliability Test .....	20
8 Mechanical Drawing.....	21
9 Packing Drawing .....	22
10 Precautions for Use of LCD Modules.....	23



## 1 General Specifications

Feature		Spec
<b>Display Spec.</b>	Size	6.0 inch
	Resolution	800(RGB) x 480
	Interface	TTL RGB 24 bits
	Color Depth	16M
	Technology Type	a-Si
	Pixel Pitch (mm)	0.1665x0.1538
	Pixel Configuration	R.G.B. Vertical Stripe
	Display Mode	TM with Normally White
	Surface Treatment(Up Polarizer)	Anti Glare
	Viewing Direction	12 o'clock
	Gray Scale Inversion Direction	6 o'clock
<b>Mechanical Characteristics</b>	LCM (W x H x D) (mm)	145.50x87.80x5.40
	Active Area(mm)	133.20x73.80
	With /Without TSP	Without TSP
	Weight (g)	TBD
	LED Numbers	21 LEDs

Note 1: Viewing direction for best image quality is different from TFT definition. There is a 180 degree shift.

Note 2: Requirements on Environmental Protection: RoHS

Note 3: LCM weight tolerance: +/- 5%

## 2 Input/Output Terminals

### 2.1 CN1 of FPC

Matching Connector of FH28S-60S-0.5SH (HIROSE)

Pin	Symbol	I/O	Description	Remark
1	AGND	P	Ground	
2	AVDD	P	Analog Power	
3	VCC	P	Digital Power Supply	
4	R0	I	Red Data(LSB)	
5	R1	I	Red Data	
6	R2	I	Red Data	
7	R3	I	Red Data	
8	R4	I	Red Data	
9	R5	I	Red Data	
10	R6	I	Red Data	
11	R7	I	Red Data	
12	G0	I	Green Data(LSB)	
13	G1	I	Green Data	
14	G2	I	Green Data	
15	G3	I	Green Data	
16	G4	I	Green Data	
17	G5	I	Green Data	
18	G6	I	Green Data	
19	G7	I	Green Data	
20	B0	I	Blue Data(LSB)	
21	B1	I	Blue Data	
22	B2	I	Blue Data	
23	B3	I	Blue Data	
24	B4	I	Blue Data	
25	B5	I	Blue Data	
26	B6	I	Blue Data	
27	B7	I	Blue Data	
28	DCLK	I	Clock Input	

29	DE	I	Data Enable Signal	
30	HSD	I	Horizontal Sync Input. Negative Polarity	
31	VSD	I	Vertical Sync Input. Negative Polarity	
32	MODE	I	DE/SYNC Mode Select. H: SYNC mode, L: DE mode	
33	RSTB	I	Global Reset Pin	
34	STBYB	I	Standby Mode Select H: normal operation, L: standby mode	
35	SHLR	I	Source Right or Left Sequence Control	
36	VCC	P	Digital Power	
37	UPDN	I	Gate Up or Down Scan Control	
38	GND	P	Ground	
39	AGND	P	Ground	
40	AVDD	P	Analog Power	
41	VCOM	I	Common Voltage Input	
42	DITH	I	Dithering Setting. H: 6bit Resolution, L: 8bit Resolution	
43	NC	N	No Connection	
44	NC	N	No Connection	
45	V10	I	Gamma Voltage 10	
46	V9	I	Gamma Voltage 9	
47	V8	I	Gamma Voltage 8	
48	V7	I	Gamma Voltage 7	
49	V6	I	Gamma Voltage 6	
50	V5	I	Gamma Voltage 5	
51	V4	I	Gamma Voltage 4	
52	V3	I	Gamma Voltage 3	
53	V2	I	Gamma Voltage 2	
54	V1	I	Gamma Voltage 1	
55	NC	N	No Connection	
56	VGH	P	Positive Power for TFT	
57	VCC	P	Digital Power	
58	VGL	P	Negative Power for TFT	
59	GND	P	Ground	

60	NC	N	No Connection	
----	----	---	---------------	--

Note: I/O definition.

I---Input pin, O---Output pin, P--- Power/Ground, N--- No Connection

## 2.2 CN2 of LED BLU Connector

Matching Connector of BHSR-02VS-1

Pin	Symbol	I/O	Description	Remark
1	LED+	P	LED Anode	Red Cable
2	LED-	P	LED Cathode	White Cable

## 2.3 U/D R/L Function Description

Scan Control Input		Scanning Direction
UPDN	SHLR	
GND	VCC	Up to Down, Left to Right
VCC	GND	Down to Up, Right to Left
GND	GND	Up to Down, Right to Left
VCC	VCC	Down to Up, Left to Right

### 3 Absolute Maximum Ratings

AGND= GND=0V, Ta = 25°C

Item	Symbol	Min	Max	Unit	Remark
Power Voltage	VCC	-0.50	5.00	V	
	AVDD	-0.50	13.50	V	
	VGH	-0.30	40.00	V	
	VGL	-20.00	0.30	V	
	VGH-VGL	-0.30	40.00	V	
Backlight Forward Current	I <sub>LED</sub>	-	25.0	mA	For each LED
Operating Temperature	T <sub>OPR</sub>	-20.0	70.0	°C	
Storage Temperature	T <sub>STG</sub>	-30.0	80.0	°C	



## 4 Electrical Characteristics

### 4.1 Recommended Operating Condition

AGND=GND=0V, Ta = 25°C

Item	Symbol	Min	Typ	Max	Unit	Remark	
Digital Supply Voltage	VCC	3.00	3.30	3.60	V		
Analog Supply Voltage	AVDD	(9.310)	(9.840)	(10.290)	V		
Gate On Voltage	VGH	(19.80)	(22.00)	(24.20)	V		
Gate Off Voltage	VGL	(-7.70)	(-7.00)	(-6.30)	V		
Common Electrode Driving Signal	VCOM	-	TBD	-	V		
Input Level Of Gamma Voltage	V1~V5	0.4xAVDD	-	AVDD-0.1	V		
	V6~V10	0.1	-	0.6xAVDD	V		
Input Signal Voltage	Low Level	V <sub>IL</sub>	0	-	0.3xVCC	V	R0~R7,G0~G7,B0~B7,DE, DCLK,HSD,VSD,MODE, RSTB,STBYB,SHLR,UPDN, VCOM,DITH,V1~V10
	High Level	V <sub>IH</sub>	0.7xVCC	-	VCC	V	
Output Signal Voltage	Low Level	V <sub>OL</sub>	0	-	0.2xVCC	V	
	High Level	V <sub>OH</sub>	0.8xVCC	-	VCC	V	

Note: The value is for design stage only.

### 4.2 Gamma Correction Reference Voltage Setting

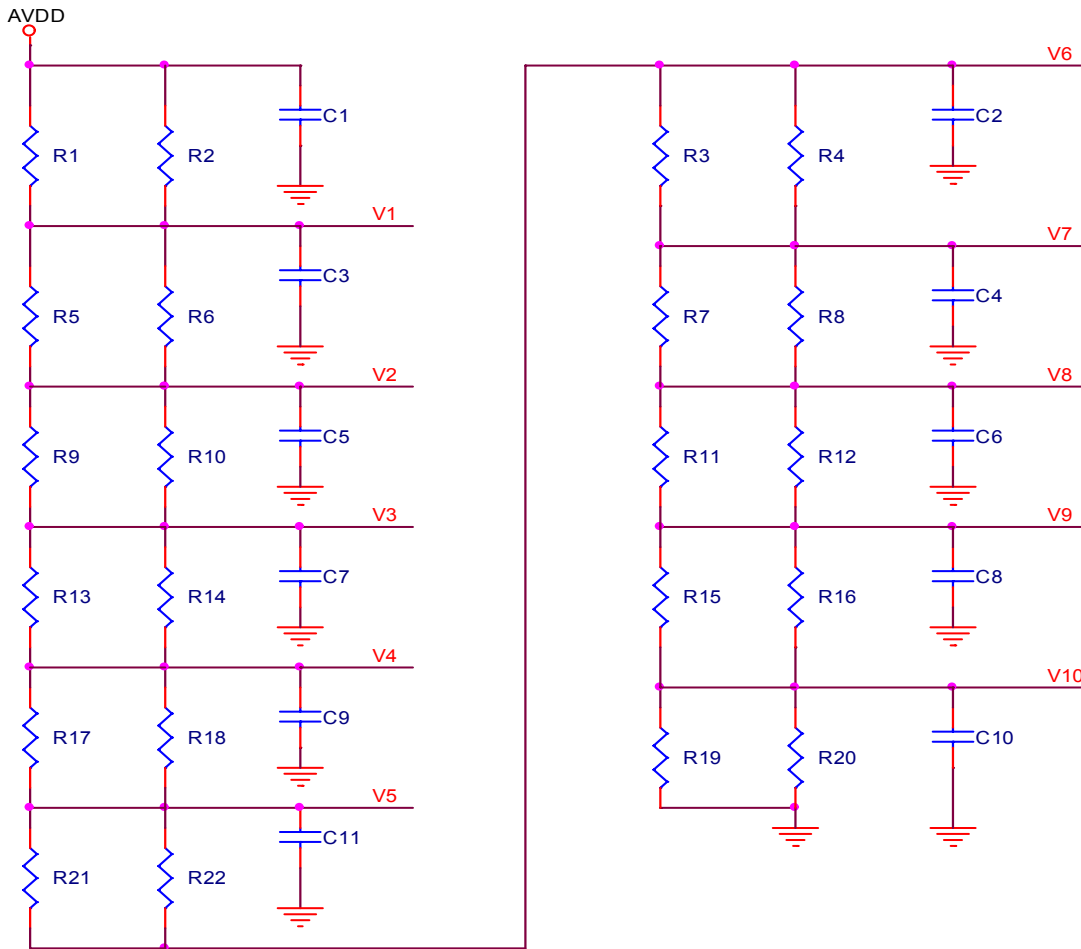

### 4.3 Recommended Driving Condition for Backlight

 $T_a=25^{\circ}\text{C}$ 

Item	Symbol	Min	Typ	Max	Unit	Remark
Forward Current	$I_F$	-	140.0	175.0	mA	21 LEDs (3 LED Serial, 7 LED Parallel)
Forward Voltage	$V_F$	-	9.6	-	V	
Backlight Power Consumption	$W_{BL}$	-	1.344	1.680	W	

Note1: The LED driving condition is defined for each LED module (3 LED Serial, 7 LED Parallel). For each LED:  $I_F(1/7)=20\text{mA}$ ,  $V_F(1/3)=3.2\text{V}$ .

Note2: Under LCM operating, the stable forward current should be inputted. And forward voltage is for reference only.

Note3: The minimum life of LED is 10,000 hours, which is defined that the brightness becomes 50% of the original value under standard condition.

Note4: The LED driving condition is defined for each LED module.

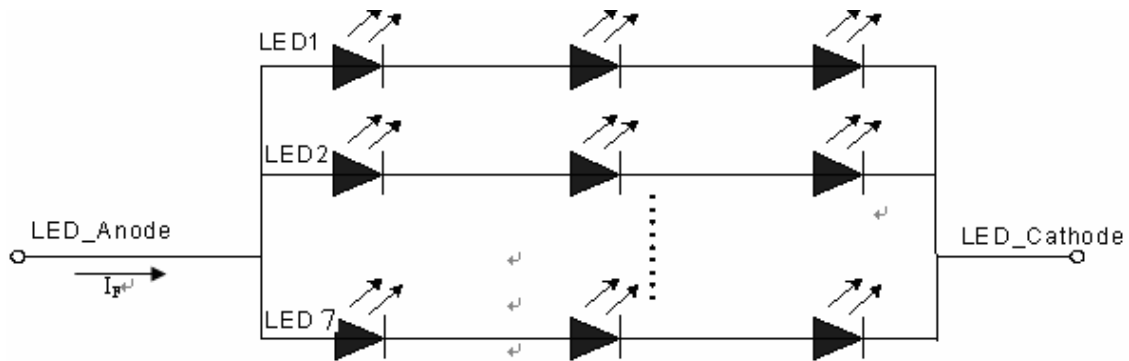

#### 4.4 Power Consumption

AGND=GND=0V, Ta = 25°C

Item	Symbol	Condition	Min	Typ	Max	Unit	Remark
Digital Supply Current	I <sub>VCC</sub>	VCC=3.3V	-	TBD	(10.0)	mA	
Analog Supply Current	I <sub>AVDD</sub>	AVDD=9.84V	-	TBD	(35.0)	mA	
Gate On Current	I <sub>VGH</sub>	VGH=22.0V	-	TBD	(0.3)	mA	
Gate Off Current	I <sub>VGL</sub>	VGL=-7.0V	-	TBD	(0.3)	mA	
Power Consumption	Panel&Gamma		-	TBD	-	W	
	Backlight		-	1.344	1.680	W	
	Total		-	TBD	-	W	

#### 4.5 Block Diagram

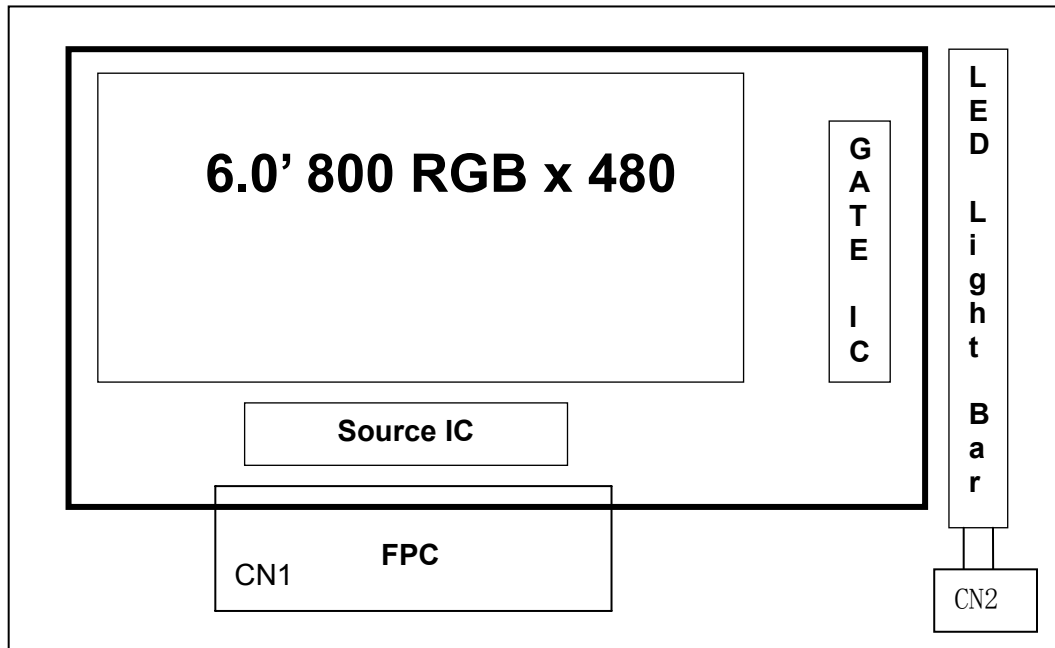

## 5 Timing Chart

### 5.1 TFT-LCD Input Timing

VCC=3.3V, AVDD=9.84V, AGND=GND=0V, Ta=25°C

Parameter	Symbol	Min	Typ	Max	Unit	Conditions
DCLK Frequency	Fclk	-	30.0	40.0	MHz	
DCLK Cycle Time	Tcph	-	33.3	25	ns	
DCLK Pulse Width	Tcw	40%	50%	60%	Tcph	
VSD Setup Time	Tvst	8			ns	
VSD Hold Time	Tvhd	8	-	-	ns	
HSD Setup Time	Thst	8			ns	
HSD Hold Time	Thhd	8	-	-	ns	
Data Setup Time	Tdsu	8			ns	Data to DCLK
Data Hold Time	Tdhd	8	-	-	ns	Data to DCLK
DE Setup Time	Tesu	8	-	-	ns	
DE Hold Time	Tehd	8	-	-	ns	
POL Hold Time	Tphd	6	-	-	ns	
Output Stable Time	Tsst	-	-	6	us	CL=120pF, R=10K 10% or 90%
HSD to Source Output	Thso	-	64	-	Tcph	
HSD to STV	Thstv	-	2	-	Tcph	
HSD to CKV	Thckv	-	20	-	Tcph	
HSD to LD	Thld	-	64	-	Tcph	
HSD to OEV	Thoev	-	4	-	Tcph	
LD Pulse Width	Twld	-	10	-	Tcph	
CKV Pulse Width	Twckv	-	66	-	Tcph	
OEV Pulse Width	Twoev	-	74	-	Tcph	
RSTB Pulse Width	Trst	50	-	-	us	
DE Setup Time	Tesu	8	-	-	ns	

## 5.2 Recommended Timing Setting Of TCON

### TCON (Embedded In Source IC) Input Timing (DCLK, HSD, VSD, DE)

VCC=3.3V, AVDD=9.84V, AGND=GND=0V, Ta=25°C

Parameter	Symbol	Min	Typ	Max	Unit	Remark
DCLK	Fclk	-	30.0	40.0	MHZ	
	tclk	-	33.3	25.0	ns	
HSD	th	928	928	928	tclk	
	thd	800	800	800	tclk	
	thpw	1	48	-	tclk	
	thb	-	88	-	tclk	
	thfp	-	40	-	tclk	
VSD	tv	-	525	-	th	
	tvd	480	480	480	th	
	tvpw	-	3	-	th	
	tvb	-	32	-	th	
	tvfp	-	13	-	th	

Note: DE timing refer to HSD, VSD input timing.

### TCON Vertical Input Timing Diagram HV

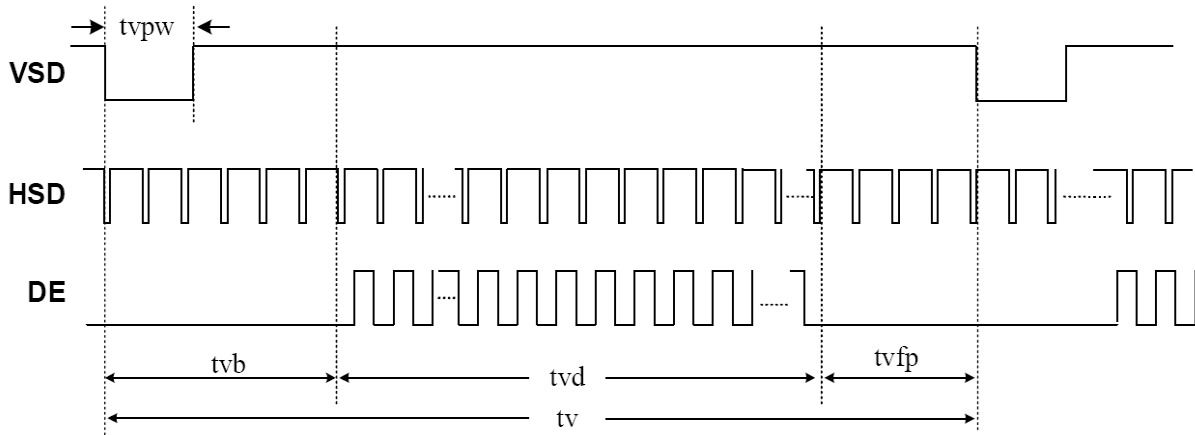

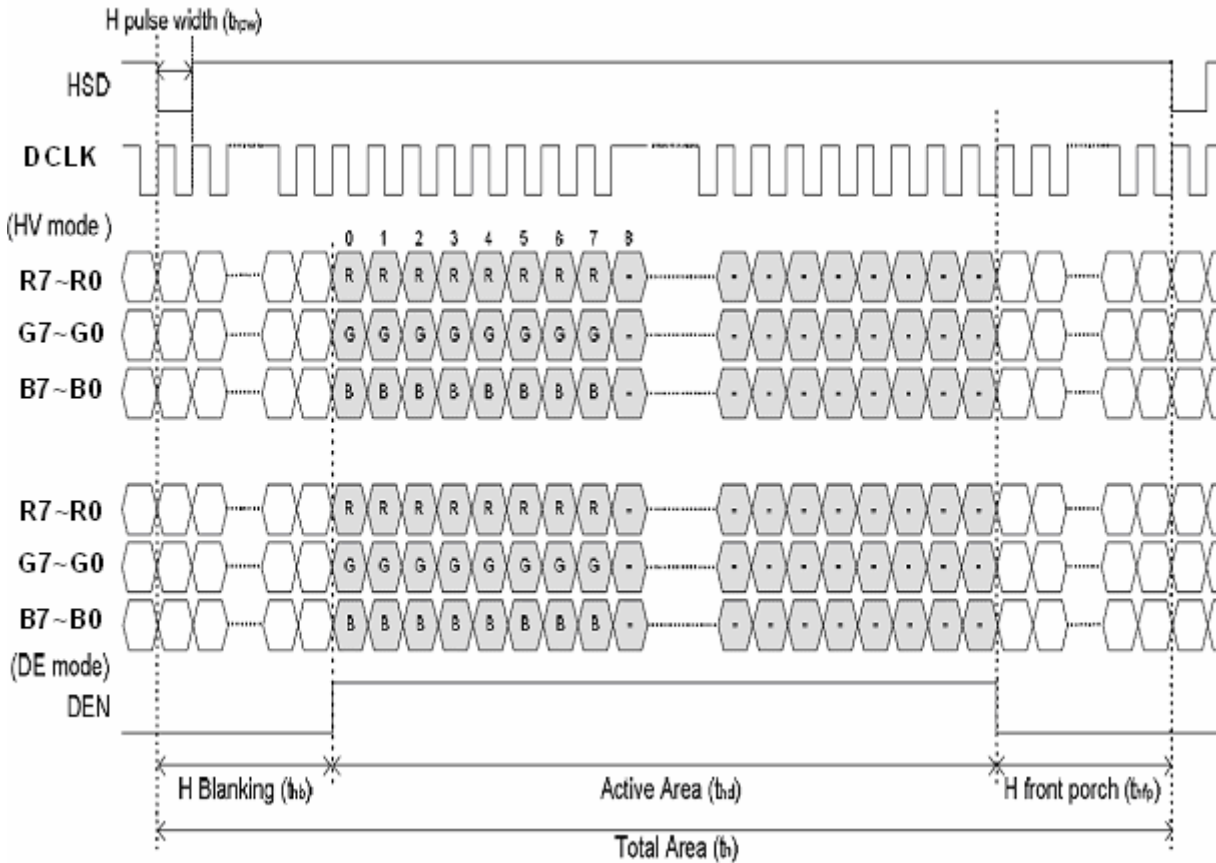
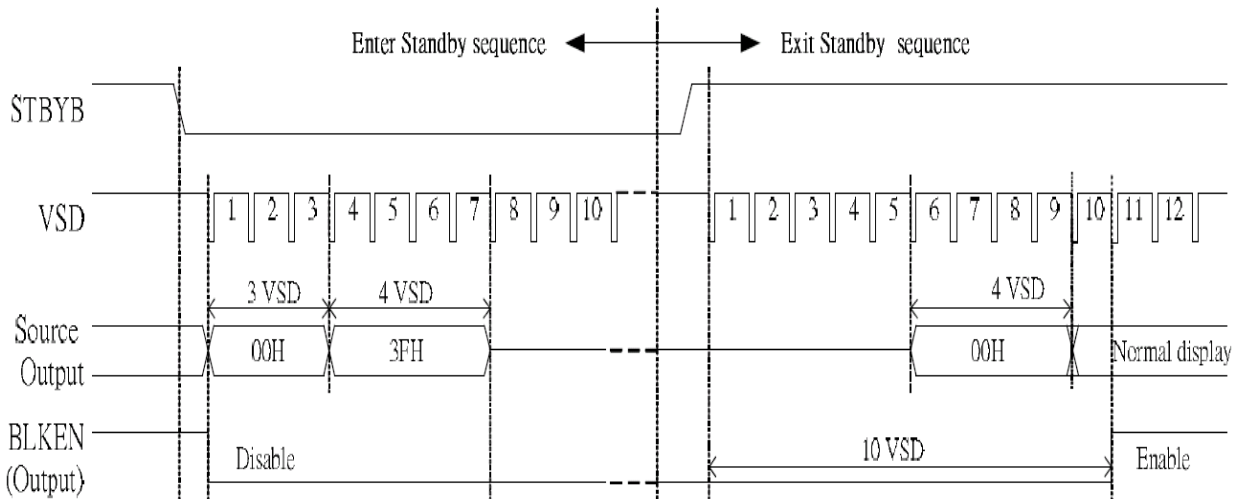
**TCON Horizontal Input Timing Diagram**

**Enter and Exit Standby Mode Sequence**

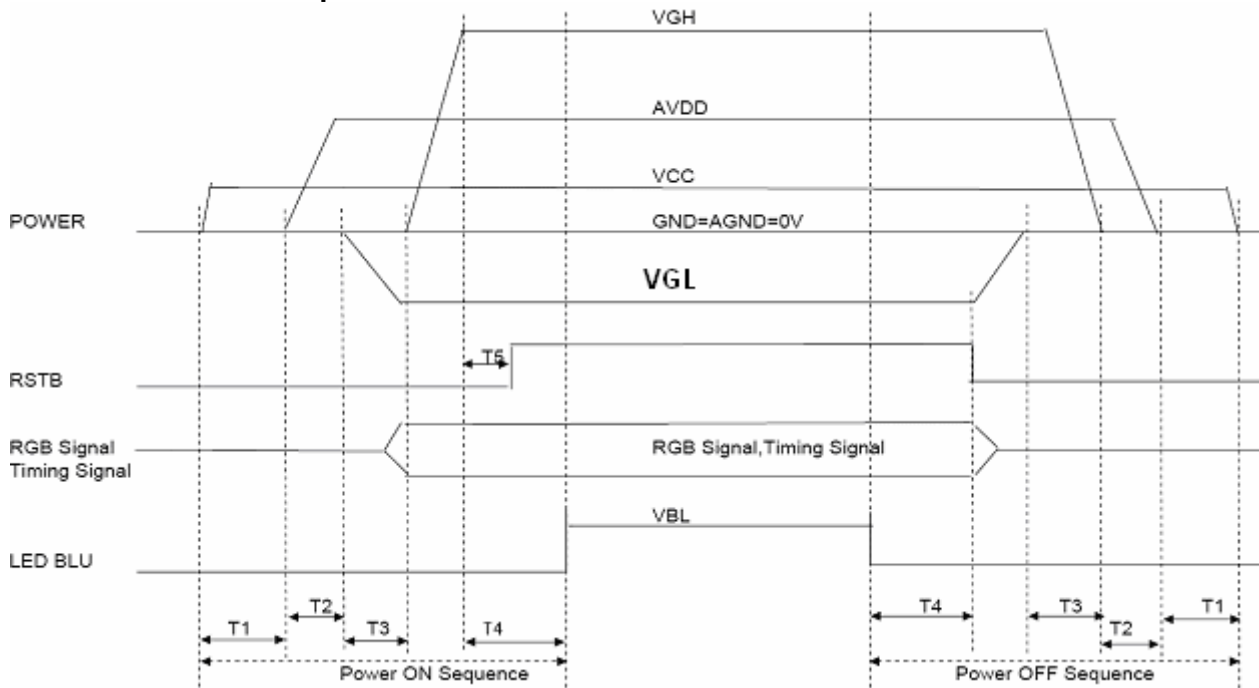
### 5.3 Power On/Off Sequence



Note: T1≥20ms, T2≥20ms, T3≥5ms, T4≥100ms, T5≥5ms.



## 6 Optical Characteristics

Ta=25°C

Item	Symbol	Condition	Min	Typ	Max	Unit	Remark
View Angles	$\theta T$	$CR \geq 10$	50	60	--	Degree	Note 2
	$\theta B$		60	70	--		
	$\theta L$		65	75	--		
	$\theta R$		65	75	--		
Contrast Ratio	CR	$\theta=0^\circ$	400	500	--		Note1 Note3
Response Time	$T_{ON}$	25°C	--	20	30	ms	Note1
	$T_{OFF}$						Note4
Chromaticity	White	x	Backlight is on	0.255	0.305	0.355	Note5 Note1
		y		0.280	0.330	0.380	
	Red	x		0.530	0.580	0.630	
		y		0.300	0.350	0.400	
	Green	x		0.295	0.345	0.395	
		y		0.525	0.575	0.625	
	Blue	x		0.095	0.145	0.195	
		y		0.065	0.115	0.165	
Uniformity	U		75	80	--	%	Note1 Note6
NTSC			--	50	--	%	Note 5
Luminance	L		320	400	--	cd/m <sup>2</sup>	Note1 Note7

Test Conditions:

1.  $I_F = 140 \text{ mA}$ ,  $V_F = 9.6 \text{ V}$ , and the ambient temperature is 25°C.
2. The test systems refer to Note 1 and Note 2.

Note 1: Definition of optical measurement system.

The optical characteristics should be measured in dark room. After 5 Minutes operation, the optical properties are measured at the center point of the LCD screen. All input terminals LCD panel must be ground when measuring the center area of the panel.

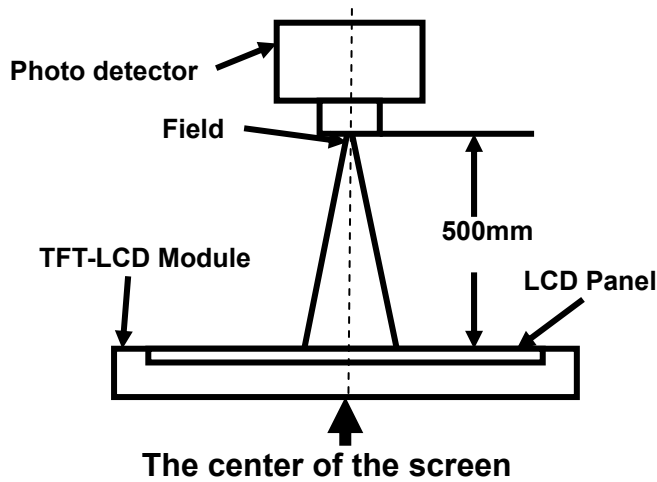

Item	Photo detector	Field
Contrast Ratio	SR-3A	1°
Luminance		
Chromaticity		
Lum Uniformity		
Response Time	BM-7A	2°

Note 2: Definition of viewing angle range and measurement system.

viewing angle is measured at the center point of the LCD by CONOSCOPE(ergo-80).

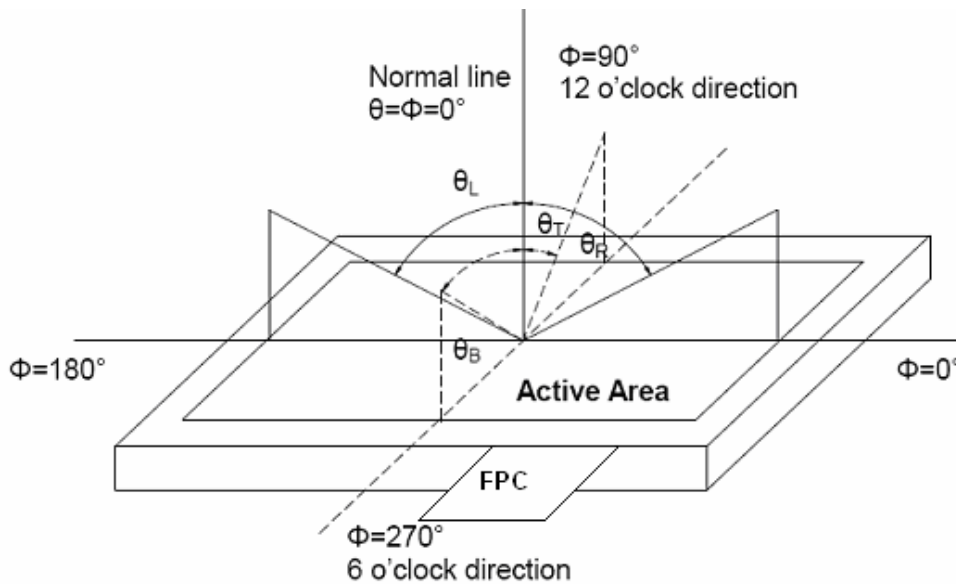

Note 3: Definition of contrast ratio

$$\text{Contrast ratio (CR)} = \frac{\text{Luminance measured when LCD is on the "White" state}}{\text{Luminance measured when LCD is on the "Black" state}}$$

“White state “: The state is that the LCD should drive by  $V_{white}$ .

“Black state”: The state is that the LCD should drive by  $V_{black}$ .

$V_{white}$ : To be determined     $V_{black}$ : To be determined.

Note 4: Definition of Response time

The response time is defined as the LCD optical switching time interval between “White” state and

“Black” state. Rise time ( $T_{ON}$ ) is the time between photo detector output intensity changed from 90% to 10%. And fall time ( $T_{OFF}$ ) is the time between photo detector output intensity changed from 10% to 90%.

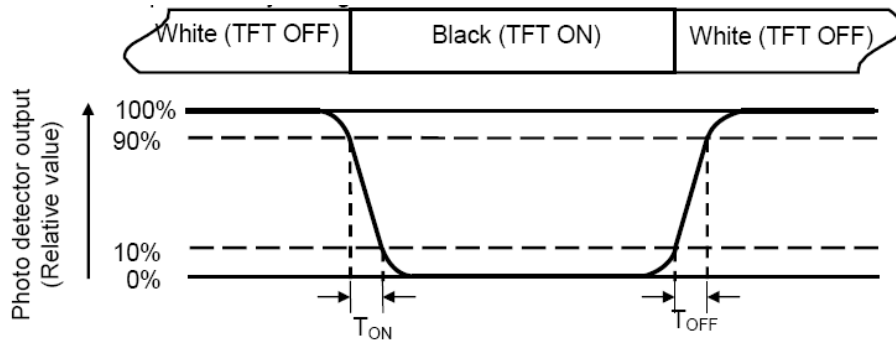

Note 5: Definition of color chromaticity (CIE1931)

Color coordinates measured at center point of LCD.

Note 6: Definition of Luminance Uniformity

Active area is divided into 9 measuring areas (Refer Fig. 2). Every measuring point is placed at the center of each measuring area.

$$\text{Luminance Uniformity (U)} = L_{\min} / L_{\max}$$

L-----Active area length W----- Active area width

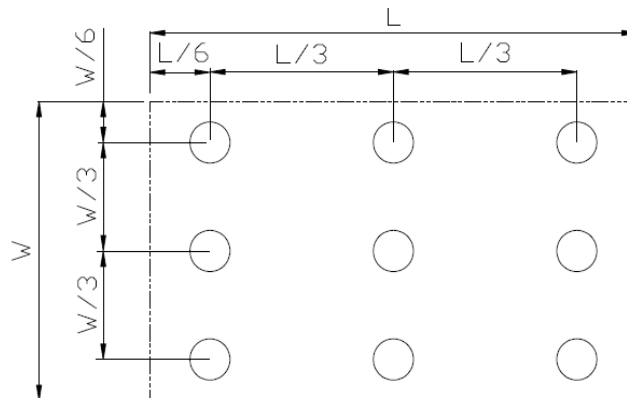

$L_{\max}$ : The measured Maximum luminance of all measurement position.

$L_{\min}$ : The measured Minimum luminance of all measurement position.

Note 7: Definition of Luminance:

Measure the luminance of white state at center point.

## 7 Environmental / Reliability Test

No	Test Item	Condition	Remarks
1	High Temperature Operation	Ts = +70°C, 240 hours	IEC60068-2-2 GB2423.2-89
2	Low Temperature Operation	Ta = -20°C, 240 hours	IEC60068-2-1 GB2423.1-89
3	High Temperature Storage	Ta = +80°C, 240 hours	IEC60068-2-2 GB2423.2-89
4	Low Temperature Storage	Ta = -30°C, 240 hours	IEC60068-2-1 GB2423.1-89
5	Storage at High Temperature and Humidity	Ta = +60°C, 90% RH max,240hours	IEC60068-2-3 GB/T2423.3-2006
6	Thermal Shock (non-operation)	-30°C 30 min~+80°C 30 min, Change time:5min, 100 Cycle	IEC60068-2-14 GB2423.22-87
7	ESD	C=150pF,R=330Ω,5point/panel Air:±8Kv,5times; Contact:±4Kv,5times (Environment:15°C~35°C, 30%~60%.86Kpa~106Kpa)	IEC61000-4-2 GB/T2423.5-1995
8	Vibration Test	Frequency range:10~55Hz Stroke:1.5mm Sweep:10Hz~55Hz~10Hz 2 hours for each direction of X.Y.Z. (6 hours for total)	IEC60068-2-6 GB/T2423.10-1995
9	Mechanical Shock (Non Op)	Half Sine Wave 100G 6ms, ±X,±Y,±Z 3times for each direction	IEC60068-2-27 GB/T2423.5-1995
10	Package Drop Test	Height:60cm, 1corner,3edges,6surfaces	IEC60068-2-32 GB/T2423.8-1995

Note1: Ts is the temperature of panel's surface.

Note2: Ta is the ambient temperature of samples.

# 8 Mechanical Drawing

Pin No.	Symbol
1	AVDD
2	AVDD
3	VCC
4	R0
5	R1
6	R2
7	R3
8	R4
9	R5
10	R6
11	R7
12	G0
13	G1
14	G2
15	G3
16	G4
17	G5
18	G6
19	G7
20	B0
21	B1
22	B2
23	B3
24	B4
25	B5
26	B6
27	B7
28	CLK
29	DE
30	HSD
31	VSD
32	MODE
33	RSTB
34	STRB
35	STR
36	VCC
37	UPDN
38	GND
39	AVDD
40	AVDD
41	VCOM
42	BIT0
43	NC
44	NC
45	VDD
46	V9
47	V8
48	V7
49	V6
50	V5
51	V4
52	V3
53	V2
54	V1
55	NC
56	VH
57	VCC
58	VDD
59	GND
60	NC

Notes:  
 1. Unmarked tolerance: ±0.30mm;  
 2. Display Type: a-Si TFT ;  
 3. Operating Temperature: -20°C~+70°C;  
 4. Storage Temperature: -30°C~+80°C;  
 5. Gray Scale Inversion: 6 o'clock;  
 6. Backlight: 3serials 7parallel;  
 7. FPC Recommended type: FH28-60S-05SKH1R5E3  
 8. Requirement on Environment Protection: Q/S0002  
 \* CC: Critical Characteristic

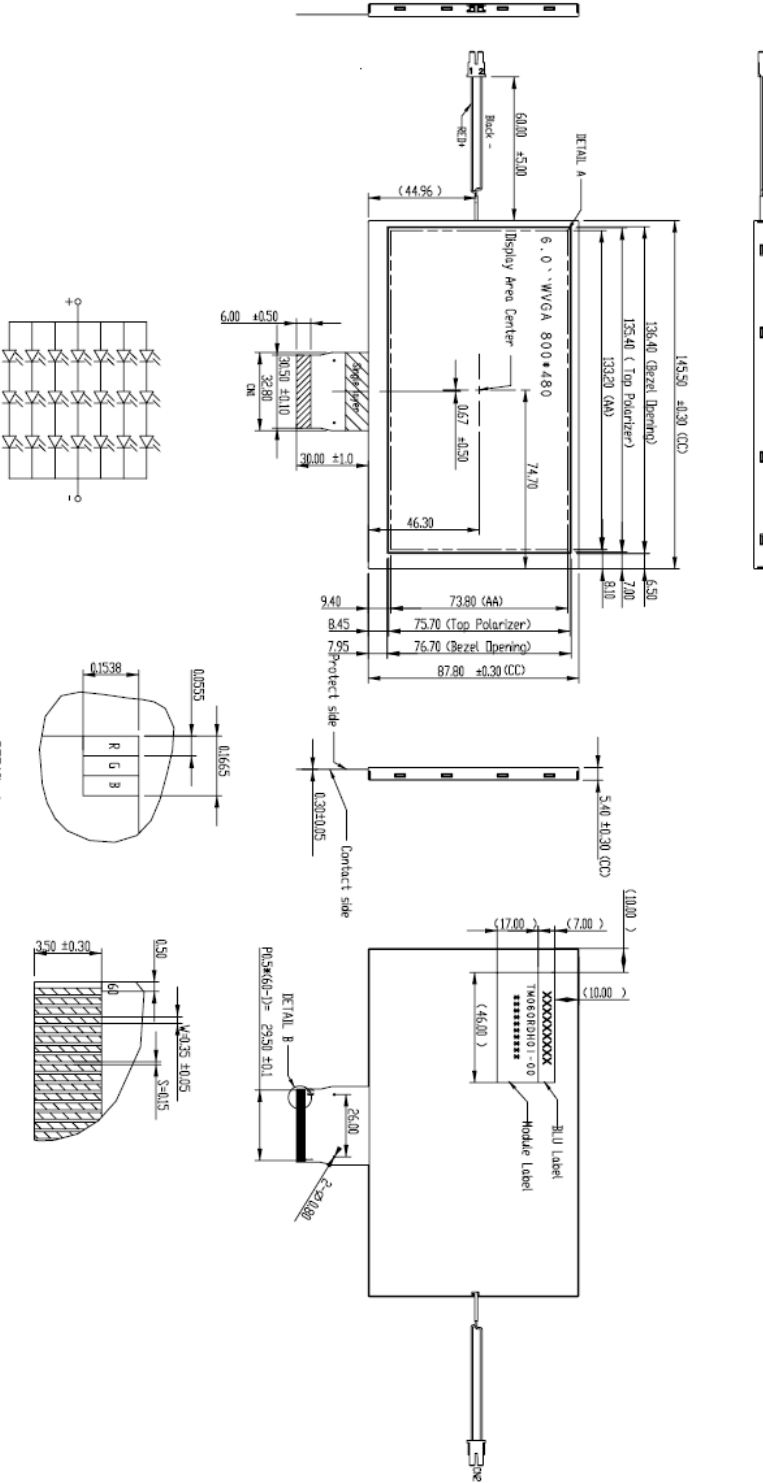

CONTROL DIMENSIONS		MULTI-INNO TECHNOLOGY CO.,LTD.	
REFERENCE DIMENSIONS	( < )		
APPROVED:	Moxiaoping	2009.5.19	
CHECKED:	Huchunyan	2009.5.19	
DESIGNED:	Linxiang	2009.5.19	
MODEL NAME	MI0600AT	3rd ANGLE	
PART NAME	LCM	UNIT	mm
DRAWING NUMBER	YGT 1-00	SCALE	2:5
MATERIAL NUMBER		PAGE	1/1

REV	DC/EC NUMBER	DESCRIPTION	DATE

## 9 Packing Drawing

No	Item	Model(Material)	Dimensions (mm)	Unit Weight (Kg)	Quantity	Remark
1	LCM		145.50x87.80x5.40	TBD	50	
2	Partition-1	Corrugated Paper	513x333x215	1.388	1	Anti-static
3	Anti-static Bag	PE	173x150x0.05	0.001	50	Anti-static
4	Dust-Proof Bag	PE	700x530	0.06	1	
5	Partition_2	Corrugated Paper	505x332x4.0	0.098	2	
6	Corrugated Paper	Corrugated Paper	513x100x30	0.048	4	
7	Carton	Corrugated Paper	530x350x250	1.12	1	
8	Total Weight (Kg)	TBD				

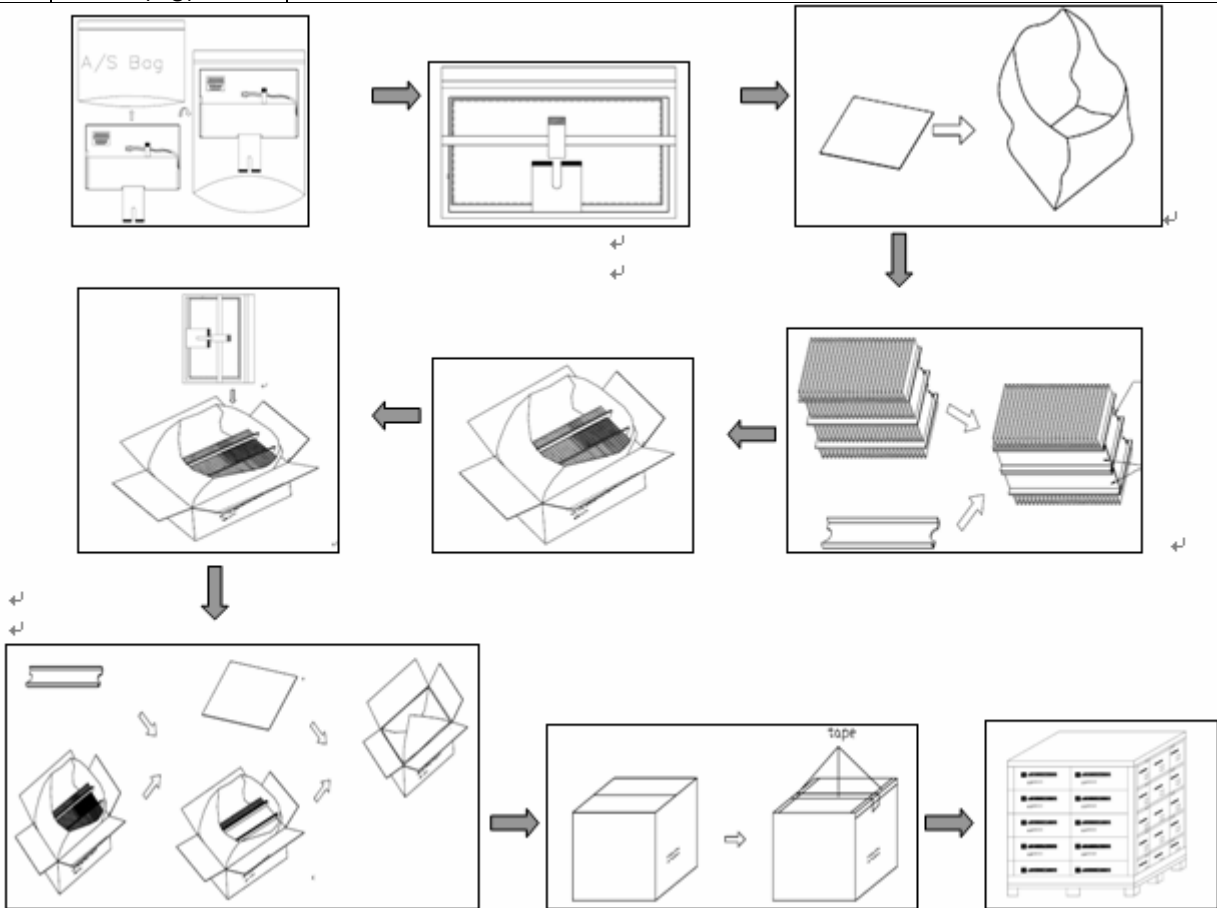

## 10 Precautions for Use of LCD Modules

### 10.1 Handling Precautions

**10.1.1** The display panel is made of glass. Do not subject it to a mechanical shock by dropping it from a high place, etc.

**10.1.2** If the display panel is damaged and the liquid crystal substance inside it leaks out, be sure not to get any in your mouth, if the substance comes into contact with your skin or clothes, promptly wash it off using soap and water.

**10.1.3** Do not apply excessive force to the display surface or the adjoining areas since this may cause the color tone to vary.

**10.1.4** The polarizer covering the display surface of the LCD module is soft and easily scratched. Handle this polarizer carefully.

**10.1.5** If the display surface is contaminated, breathe on the surface and gently wipe it with a soft dry cloth. If still not completely clear, moisten cloth with one of the following solvents:

- Isopropyl alcohol
- Ethyl alcohol

Solvents other than those mentioned above may damage the polarizer. Especially, do not use the following:

- Water
- Ketone
- Aromatic solvents

**10.1.6** Do not attempt to disassemble the LCD Module.

**10.1.7** If the logic circuit power is off, do not apply the input signals.

**10.1.8** To prevent destruction of the elements by static electricity, be careful to maintain an optimum work environment.

10.1.8.1 Be sure to ground the body when handling the LCD Modules.

10.1.8.2 Tools required for assembly, such as soldering irons, must be properly ground.

10.1.8.3 To reduce the amount of static electricity generated, do not conduct assembly and other work under dry conditions.

10.1.8.4 The LCD Module is coated with a film to protect the display surface. Be care when peeling off this protective film since static electricity may be generated.

### 10.2 Storage precautions

10.2.1 When storing the LCD modules, avoid exposure to direct sunlight or to the light of fluorescent lamps.

10.2.2 The LCD modules should be stored under the storage temperature range. If the LCD modules will be stored for a long time, the recommend condition is:

Temperature : 0°C ~ 40°C      Relatively humidity: ≤80%

10.2.3 The LCD modules should be stored in the room without acid, alkali and harmful gas.

### 10.3 Transportation Precautions

10.3.1 The LCD modules should be no falling and violent shocking during transportation, and also should avoid excessive press, water, damp and sunshine.