

DETAILS

Product Number	C13749_HB-2X2-O
Family	High Bay
Type	Lens
Color	clear
Diameter	50 + 50 mm
Height	10,6 mm
Style	square
Optic Material	PMMA
Holder Material	
Fastening	glue, screw, pin
Status	production ready
ROHS Compliant	Yes
Date Updated	21/04/2016



OPTICAL PROPERTIES

LED	Viewing Angle	Light Beam	Efficiency	cd/lm	Connector
XP-G2	27+112 deg	Oval	94 %	1.200	-
XM-L	29+109 deg	Oval	94 %	0.980	-
XM-L2	30+106 deg	Oval	94 %	1.000	-
XP-G	26+115 deg	Oval	94 %	1.130	-
XP-L	29+117 deg	Oval	94 %	0.890	-
XQ-E HI	sim: 96+14	Oval	93 %	1.700	-
XHP35 HD	sim: 102+35	Oval	sim: 91 %	sim: 0.910	-
XHP35 HI	sim: 101+27	Oval	sim: 94 %	sim: 1.200	-
XP-G3	sim: 103+29	Oval	sim: 94 %	sim: 1.100	-
XP-L2	28+117 deg	Oval	94 %	0.930	-
H35C1 (LEMWA33)	23+110 deg	Oval	94 %	1.200	-
LUXEON Rebel ES	25+106 deg	Oval	94 %	1.200	-
LUXEON T	26+110 deg	Oval	94 %	1.200	-
LUXEON R	25+105 deg	Oval	94 %	1.240	-
LUXEON MZ	28+103 deg	Oval	94 %	1.100	-
LUXEON TX	24+118 deg	Oval	94 %	1.080	-
LUXEON 5050	29+114 deg	Oval	94 %	0.940	-
NVSxx19A	24+105 deg	Oval	94 %	1.220	-
NVSxx19B/NVSxx19C	26+108 deg	Oval	94 %	1.200	-
NCSxx19B	23+113 deg	Oval	94 %	1.400	-
NWSx229A	27+118 deg	Oval	94 %	1.000	-
NVSW3x9A	25+134 deg	Oval	93 %	0.400	-
NVSxE21A	17+125 deg	Oval	94 %	1.680	-
NVSW3x9A	24+119 deg	Oval	94 %	1.100	-
Oslon Square PC	25+124 deg	Oval	91 %	1.070	-



PRODUCT DATASHEET

High Bay series

last update 21/4/2016

OPTICAL PROPERTIES

LED	Viewing Angle	Light Beam	Efficiency	cd/lm	Connector
Duris S8	sim: 95+25	Oval	sim: 93 %	sim: 0.950	-
Duris P8	sim: 99+19	Oval	sim: 94 %	sim: 1.300	-
Fortimo FastFlex LED board 2x8/740 DA 23	23+108 deg	Oval	94 %	1.300	-
LH351Z	26+117 deg	Oval	94 %	1.100	-
LH351B	23+113 deg	Oval	94 %	1.210	-
LH351D	27+116 deg	Oval	94 %	0.970	-
Z5M1/Z5M2	sim: 22+97	Oval	sim: 94 %	sim: 1.200	-
TL1L4	24+119 deg	Oval	89 %	1.100	-
RLE G1 49x223mm 4000lm xxx EXC OT	23+104 deg	Oval	94 %	1.300	-
RLE G1 49x245mm 4000lm xxx EXC OT	23+104 deg	Oval	94 %	1.300	-
RLE G1 49x121mm 2000lm xxx EXC OT	23+104 deg	Oval	94 %	1.300	-
RLE G1 49x133mm 2000lm xxx EXC OT	23+104 deg	Oval	94 %	1.300	-

Relative intensity of C13749_HB-2X2-O_(XM-L)

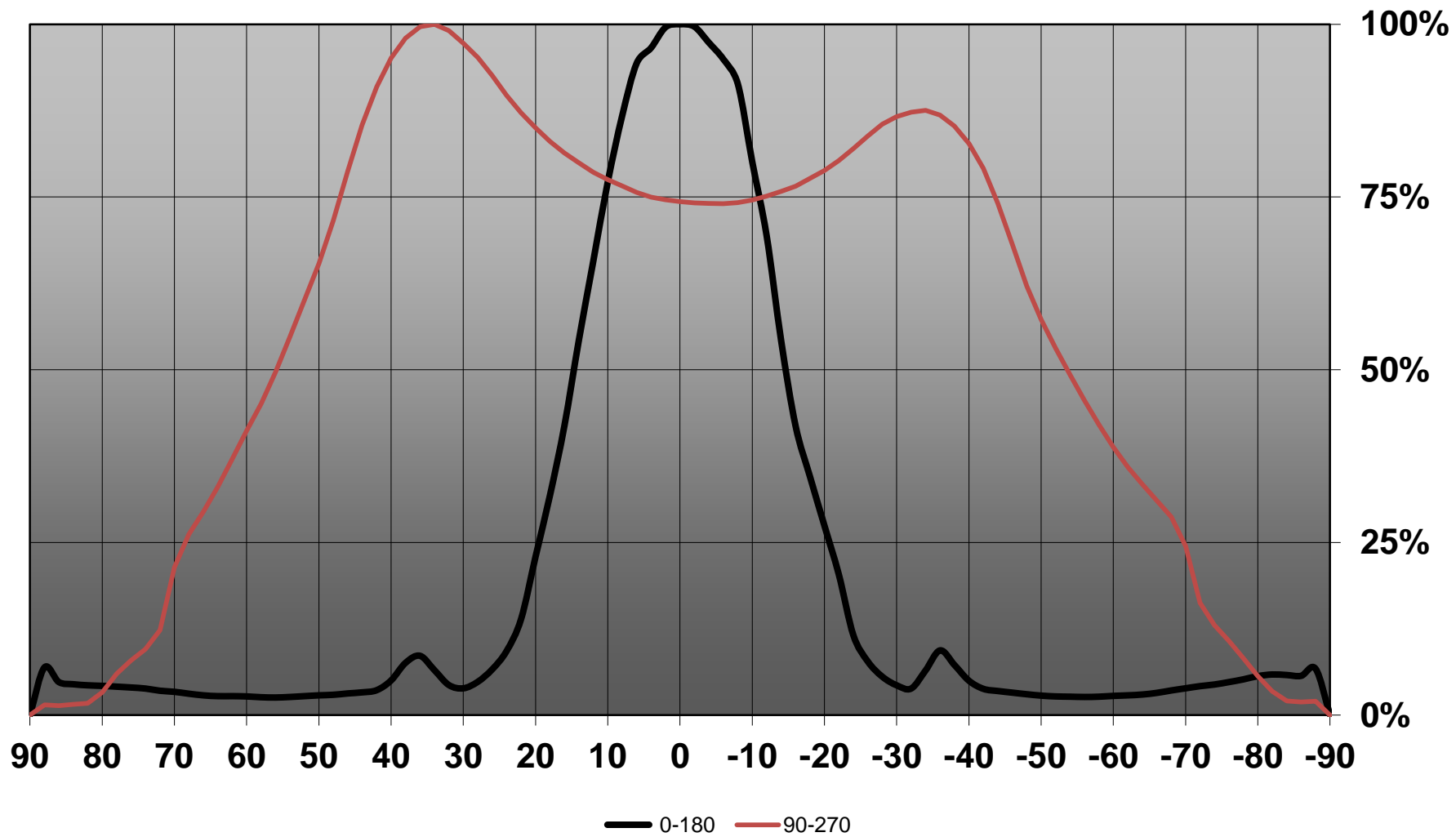

Relative intensity of C13749_HB-2X2-O_(XP-G)

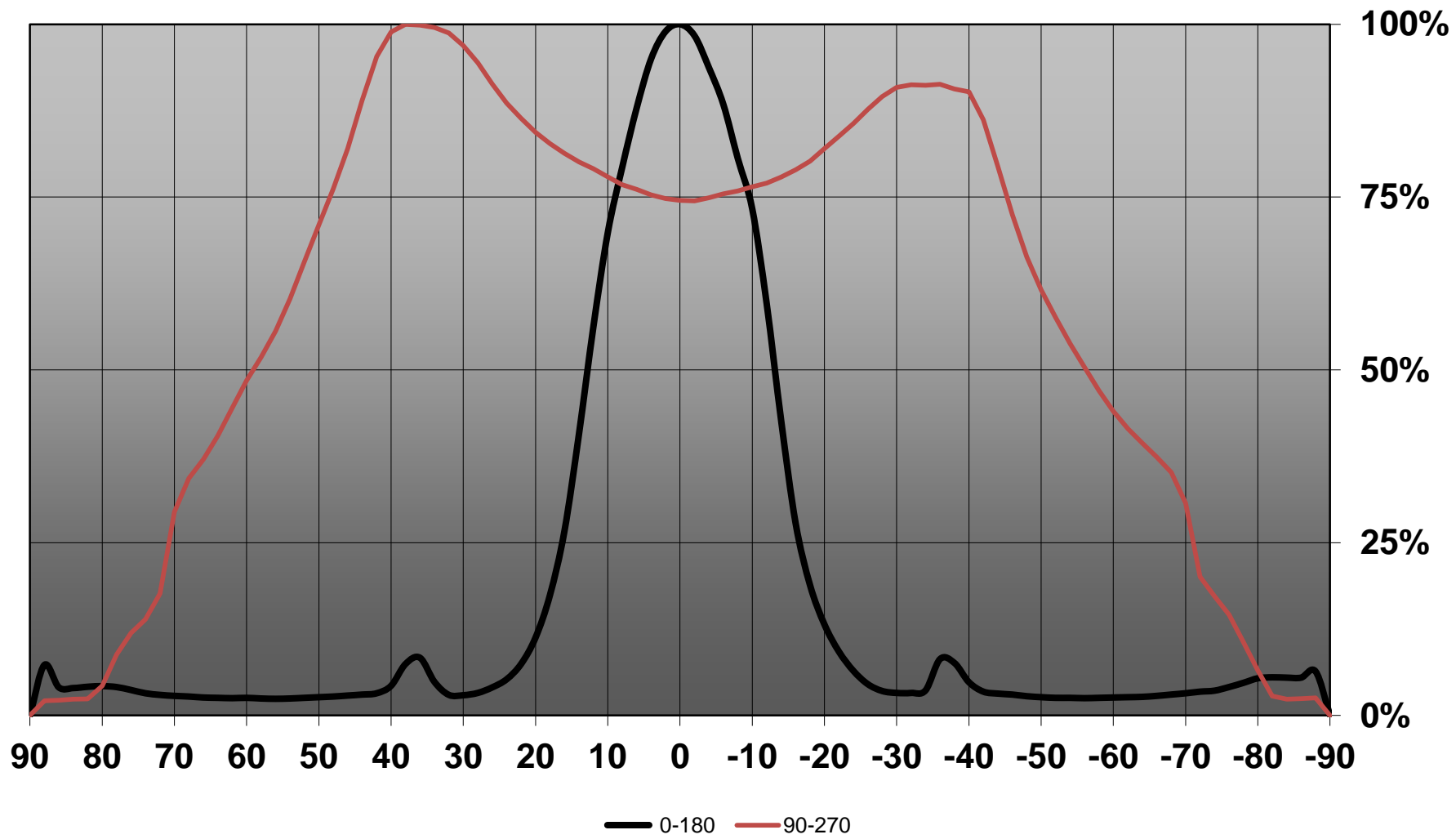

Relative intensity of C13749_HB-2X2-O_(Rebel ES)

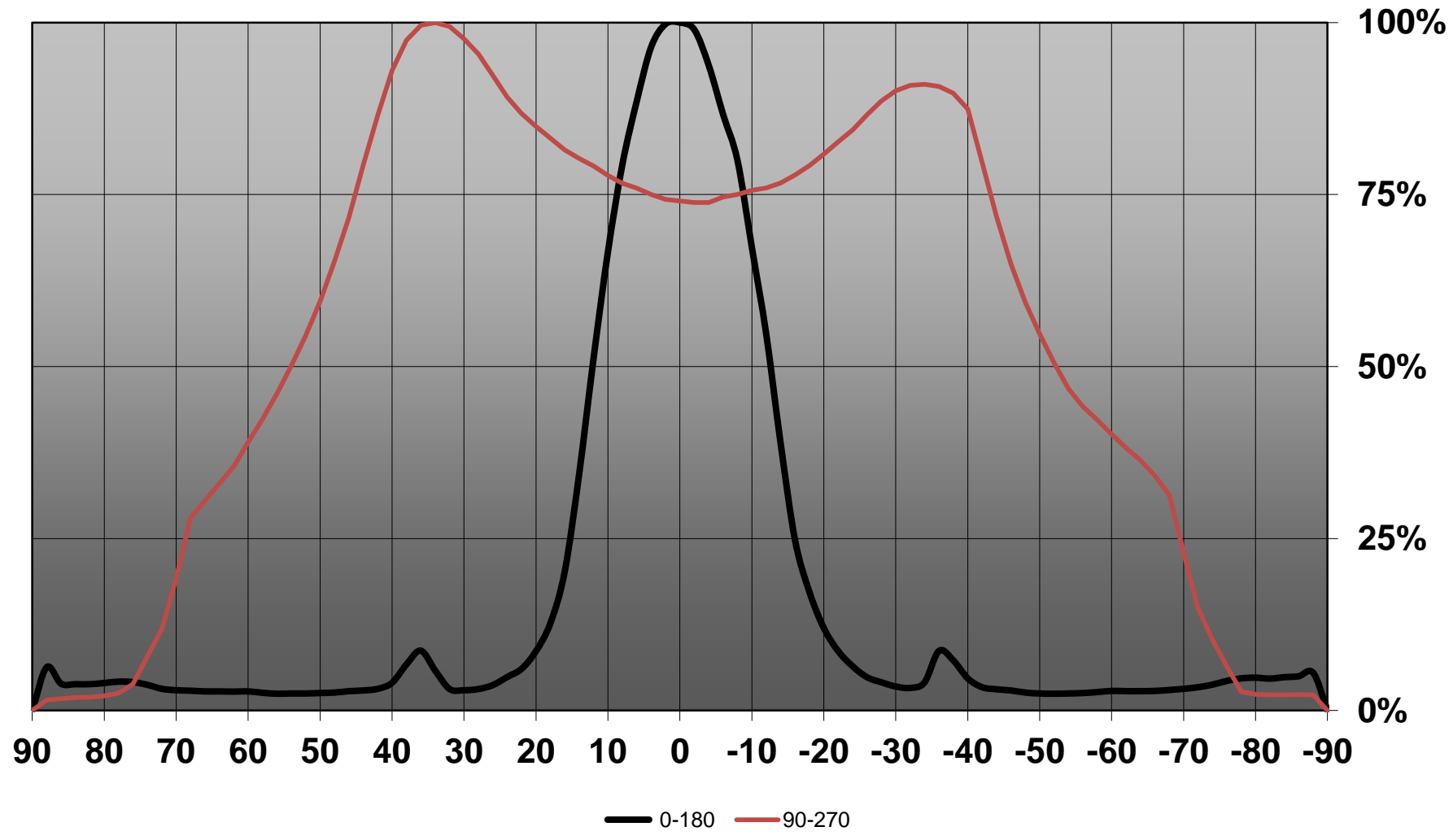

Relative intensity of C13749_HB-2X2-O_(Luxeon R)

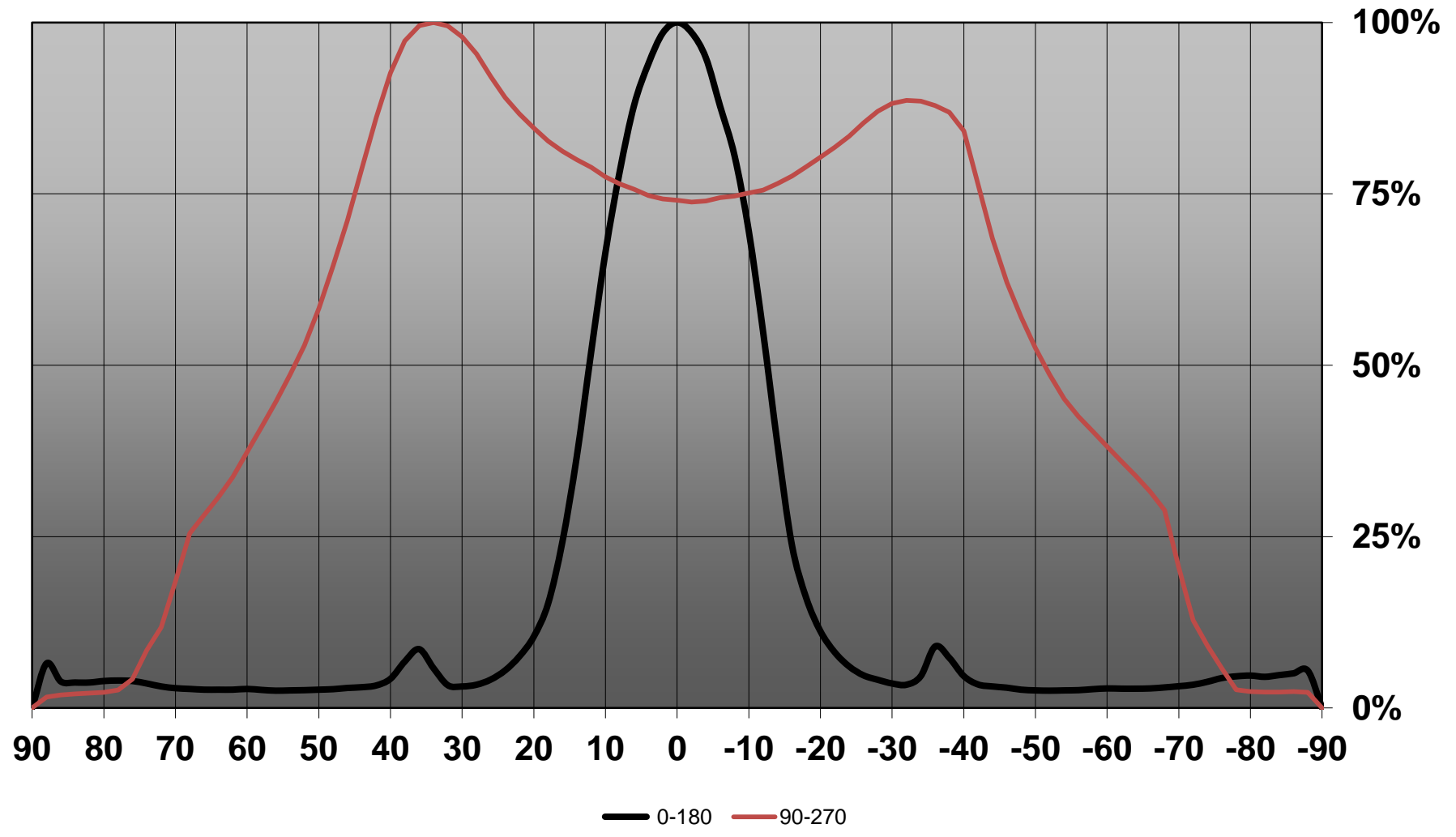

Relative intensity of C13749_HB-2X2-O_(NVSxx19A)

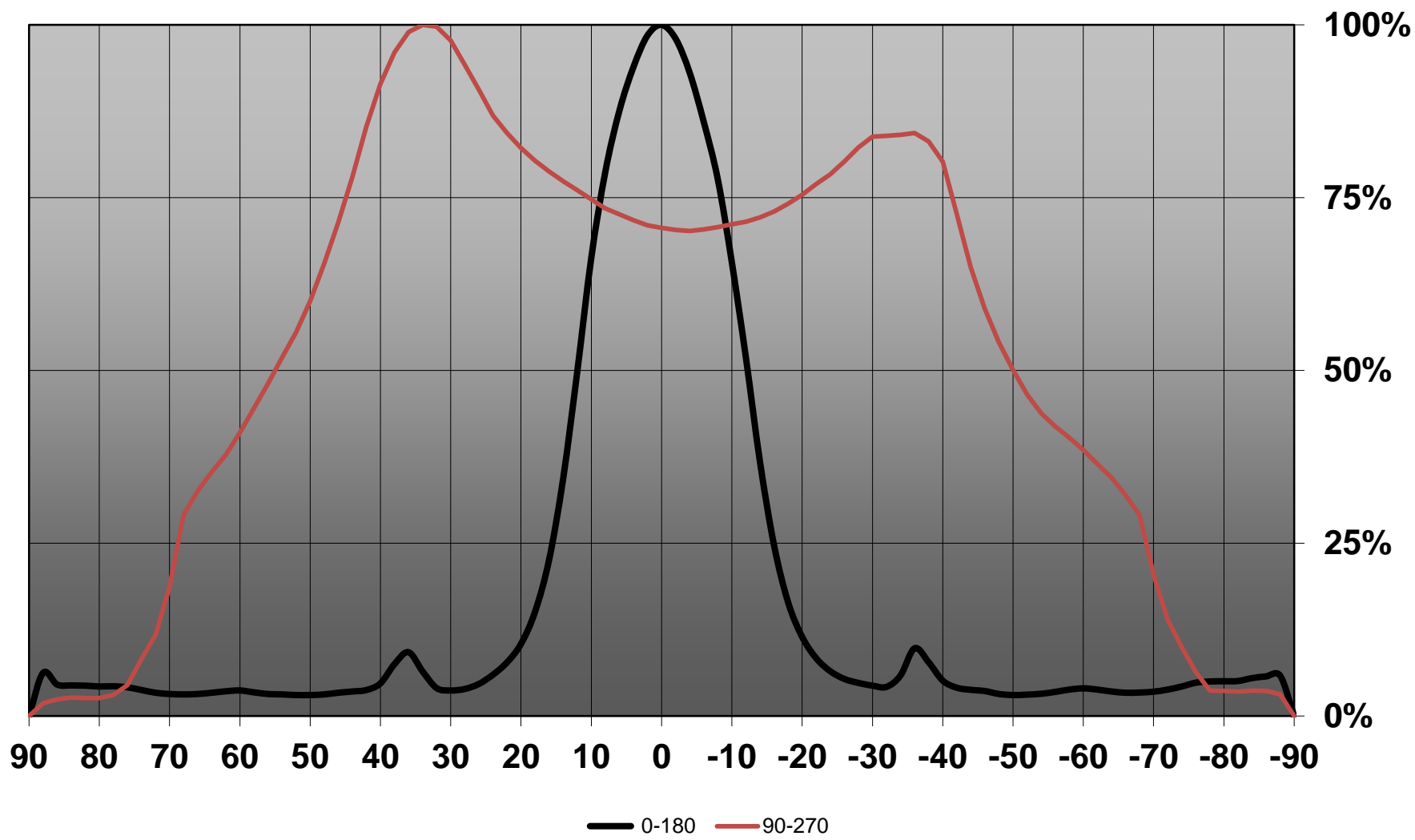

H G F E D C B A

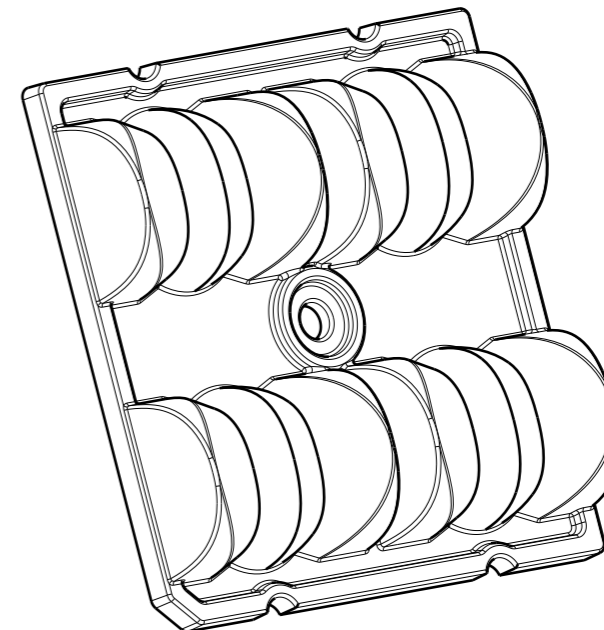
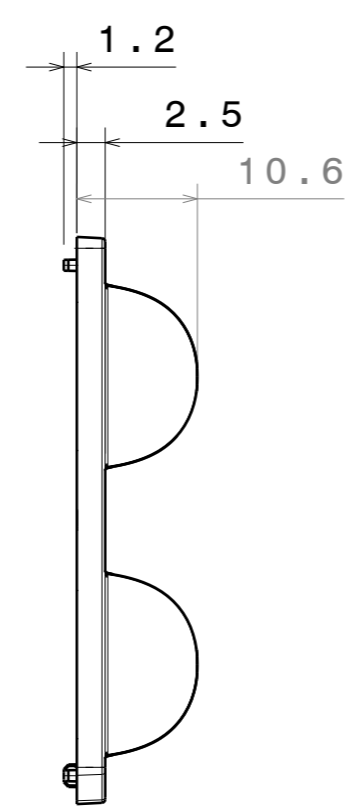
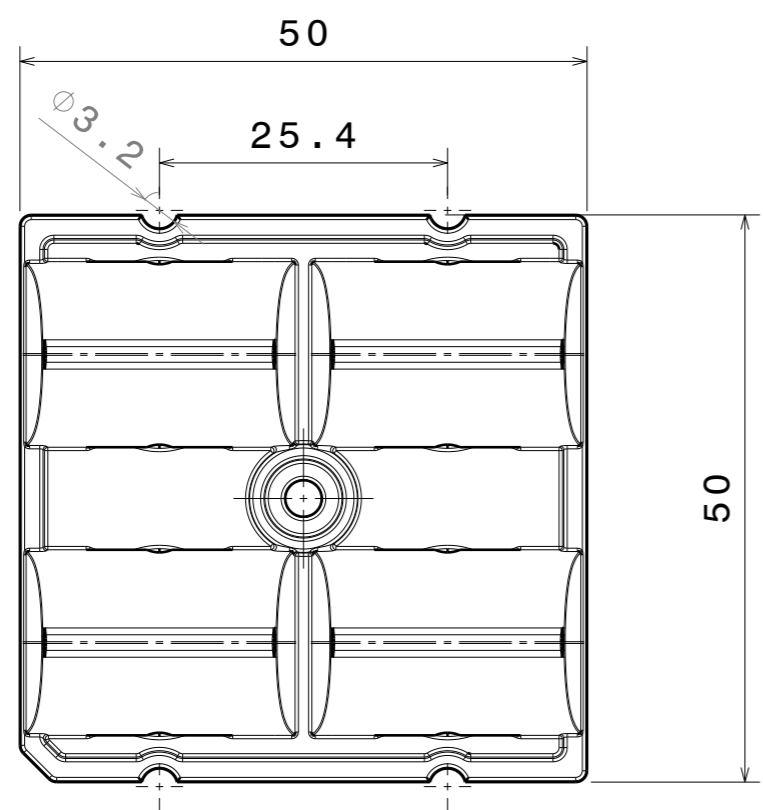

Isometric view

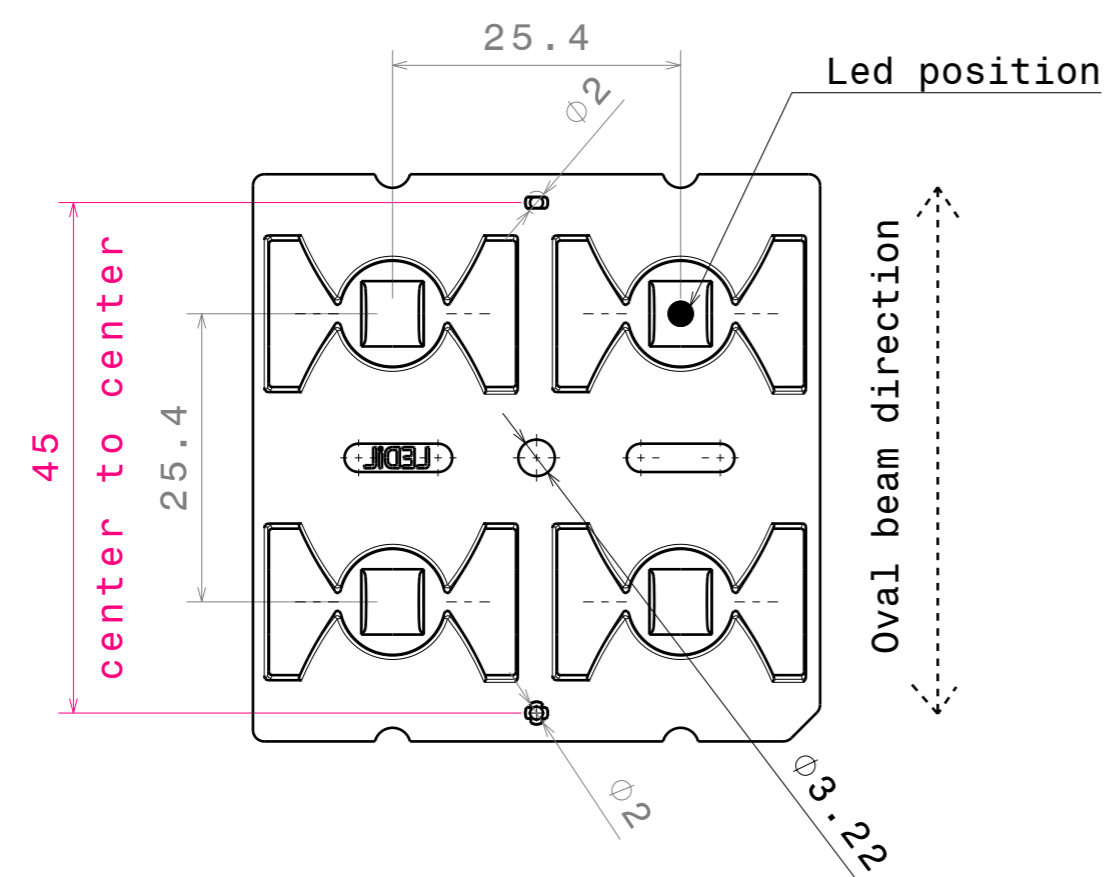

INDEX	PART NO	DESCRIPTION	MATERIAL	COLOUR
1	HB-2X2-0			

Tolerances if not otherwise shown
According to DIN ISO 2768-1
Linear measures:
Up to 30mm class M, otherwise class C.
According to DIN ISO 2768-2
Form and position: class L

LEDiL LediL Oy
Salorankatu 10
FIN 24240 SALO
Finland

THIRD ANGLE PROJECTION:

DRAWING TITLE
HB-2X2-0

This drawing is the property of LEDiL Oy. It may not be reproduced, copied or communicated without a written agreement with LEDiL Oy."

SIZE	PART NUMBER		
A3	-		

SCALE	3:2	WEIGHT	-	SHEET	1/1
-------	-----	--------	---	-------	-----

H G B A

Luminaire: LEDil Oy C13749_HB-2X2-O_(XP-G2) Efficiency=94%
Lamps: 1 x Cree XP-G2 (XPGBWT-L1-000-00G51) 411lm @ 250mA CCT=7200K P=2.9W I=250mA

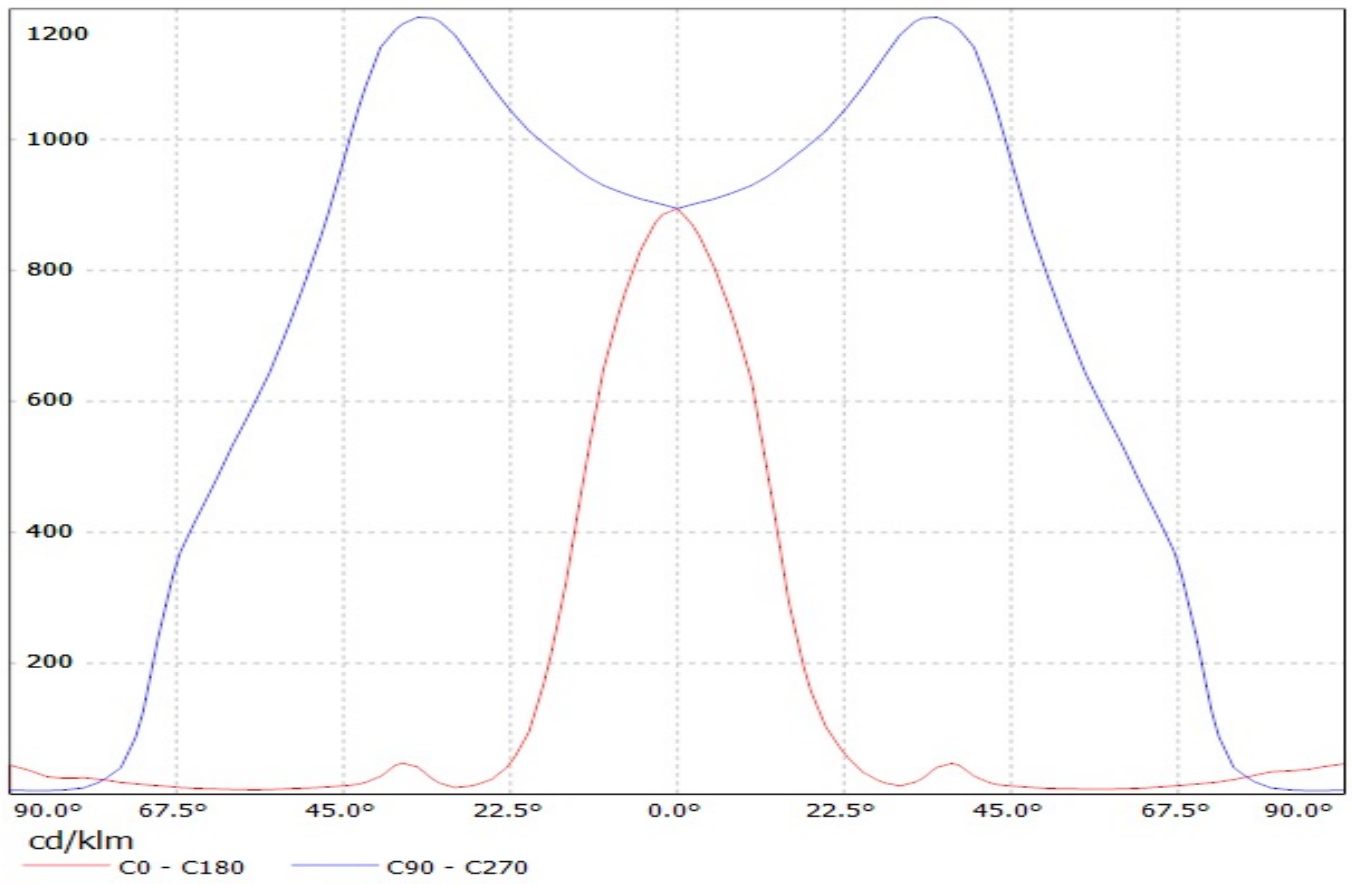

Luminaire: LEDil Oy C13749_HB-2X2-O_(XM-L2) Efficiency=94%
Lamps: 1 x Cree XM-L2 (XMLBWT-0-7B4-T30-0L-0001) 356lm @ 250mA CCT=3200K P=2.8W I=250mA

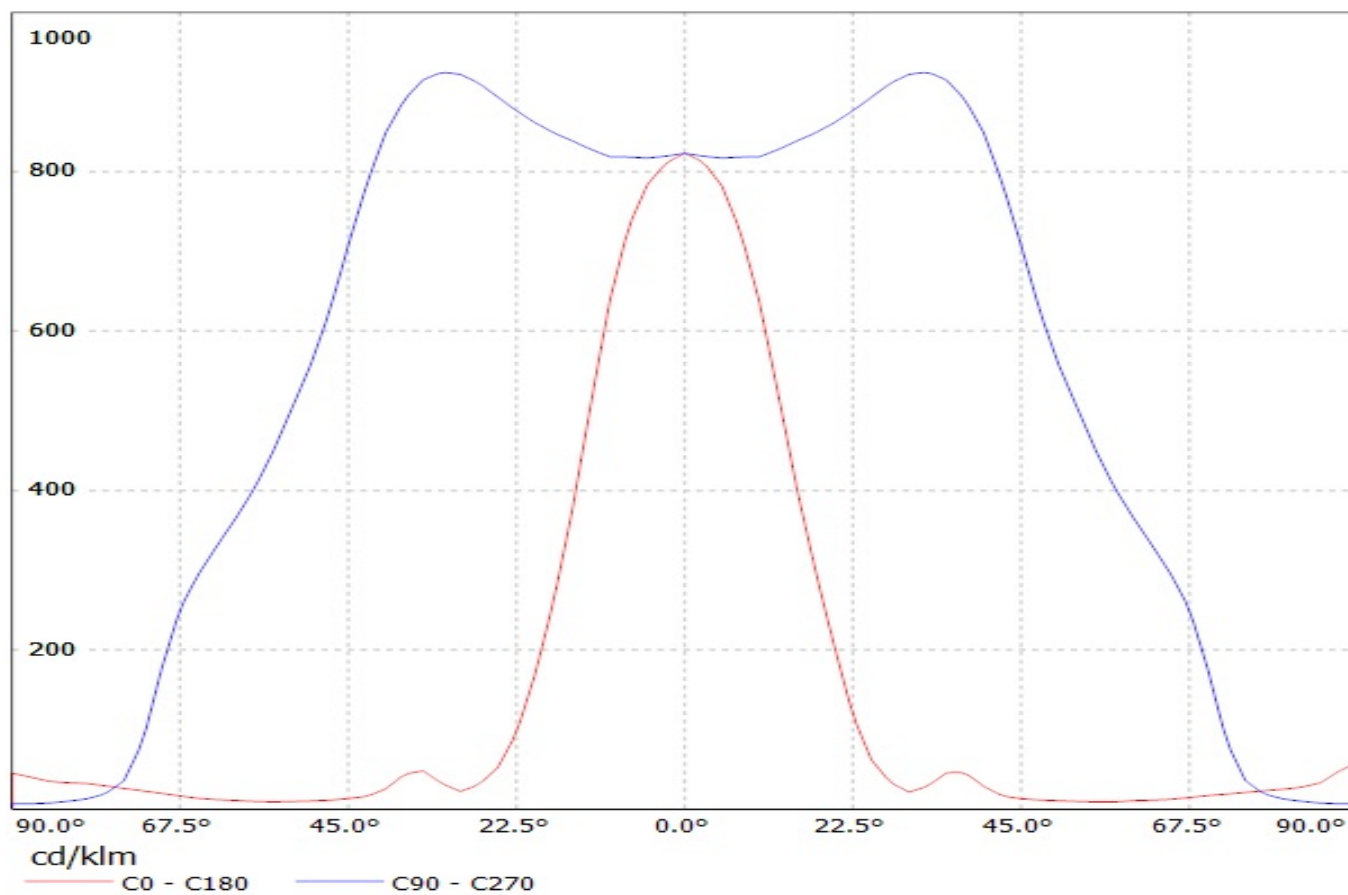

Luminaire: Ledil Oy C13749_HB-2X2-O_(XP-G)_SIMULATED
Lamps: 1 x Cree XP-G

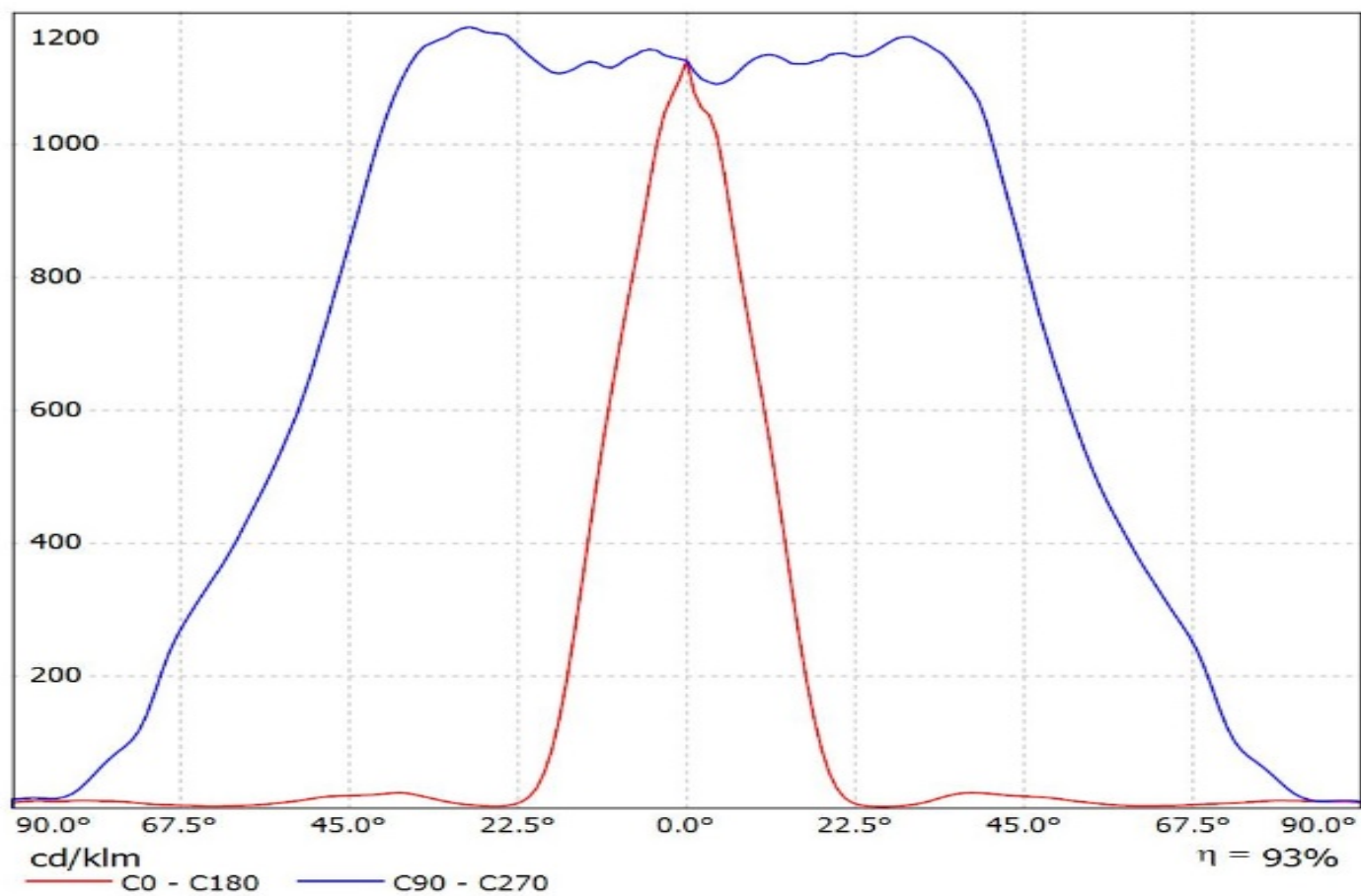

Luminaire: LEDiL Oy C13749_HB-2X2-O_(XP-L)

Lamps: 1 x CREE_XP-L_2x2_(XPLAWT-0-1B0-V40-00-0001)_490lm@250mA_CCT=7600K_P=2.79963W_I=249.9mA

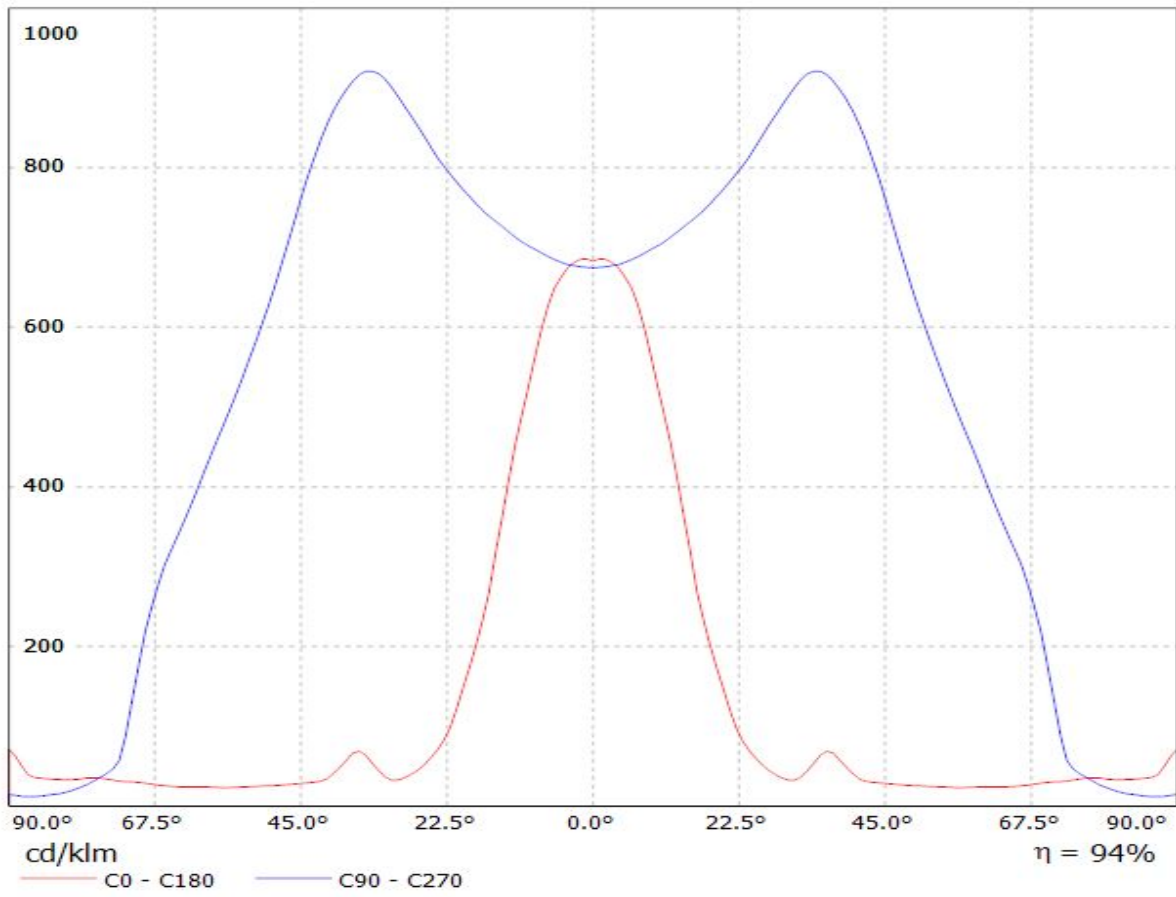

Luminaire: Ledil Oy C13749_HB-2X2-O_(XP-G3)_SIMULATED C13749_HB-2X2-O_(XP-G3)_SIMULATED
Lamps: 1 x Cree XP-G3 - 1.00 W

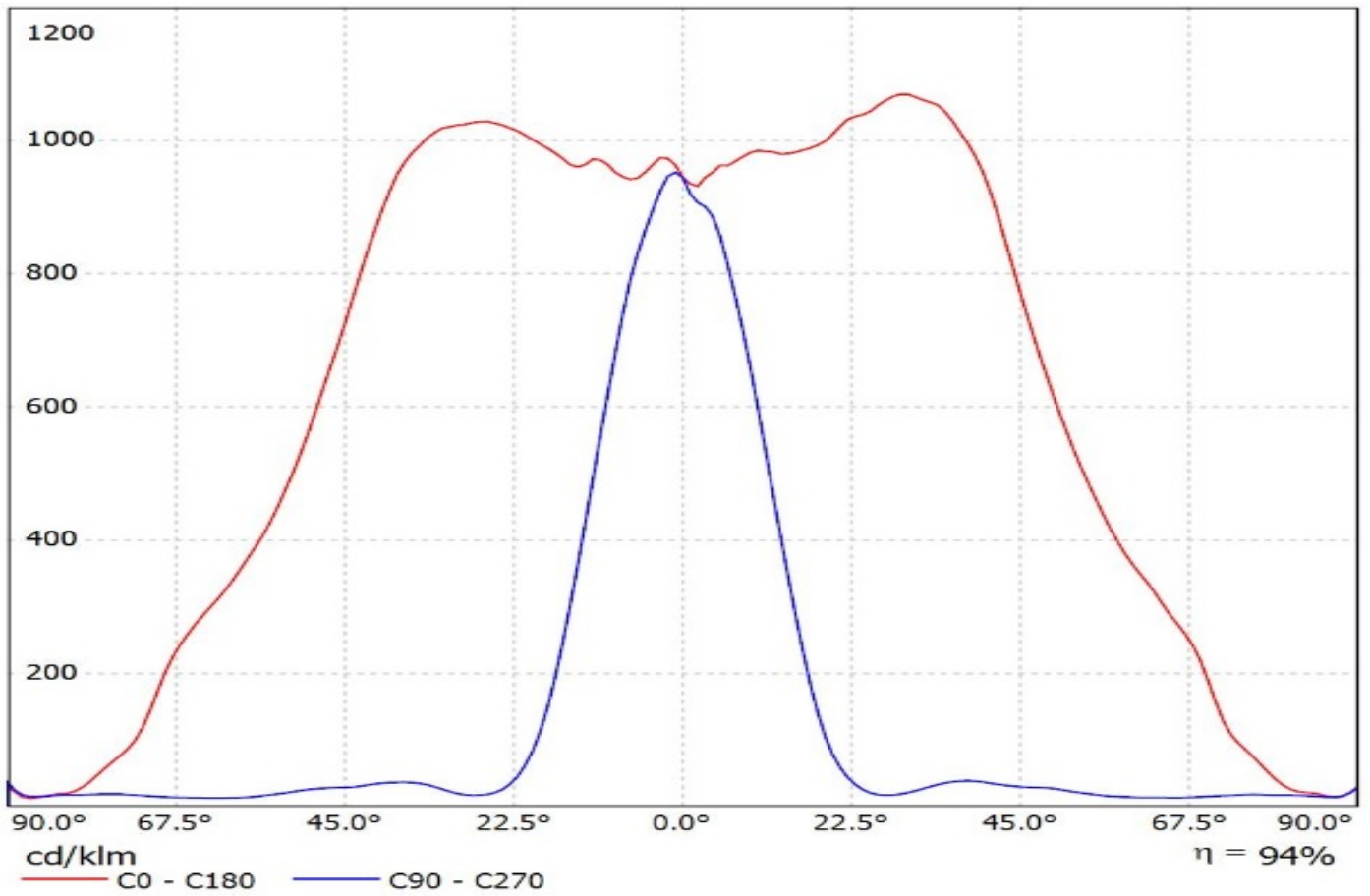

Luminaire: Ledil C13749_HB-2X2-O_(XP-L2)

Lamps: 1 x Cree_XP-L2_2x2_(XPLBWT-00-0000-000BV50E3)550.93lm@250mA_P=2.7815W_I=0.25A

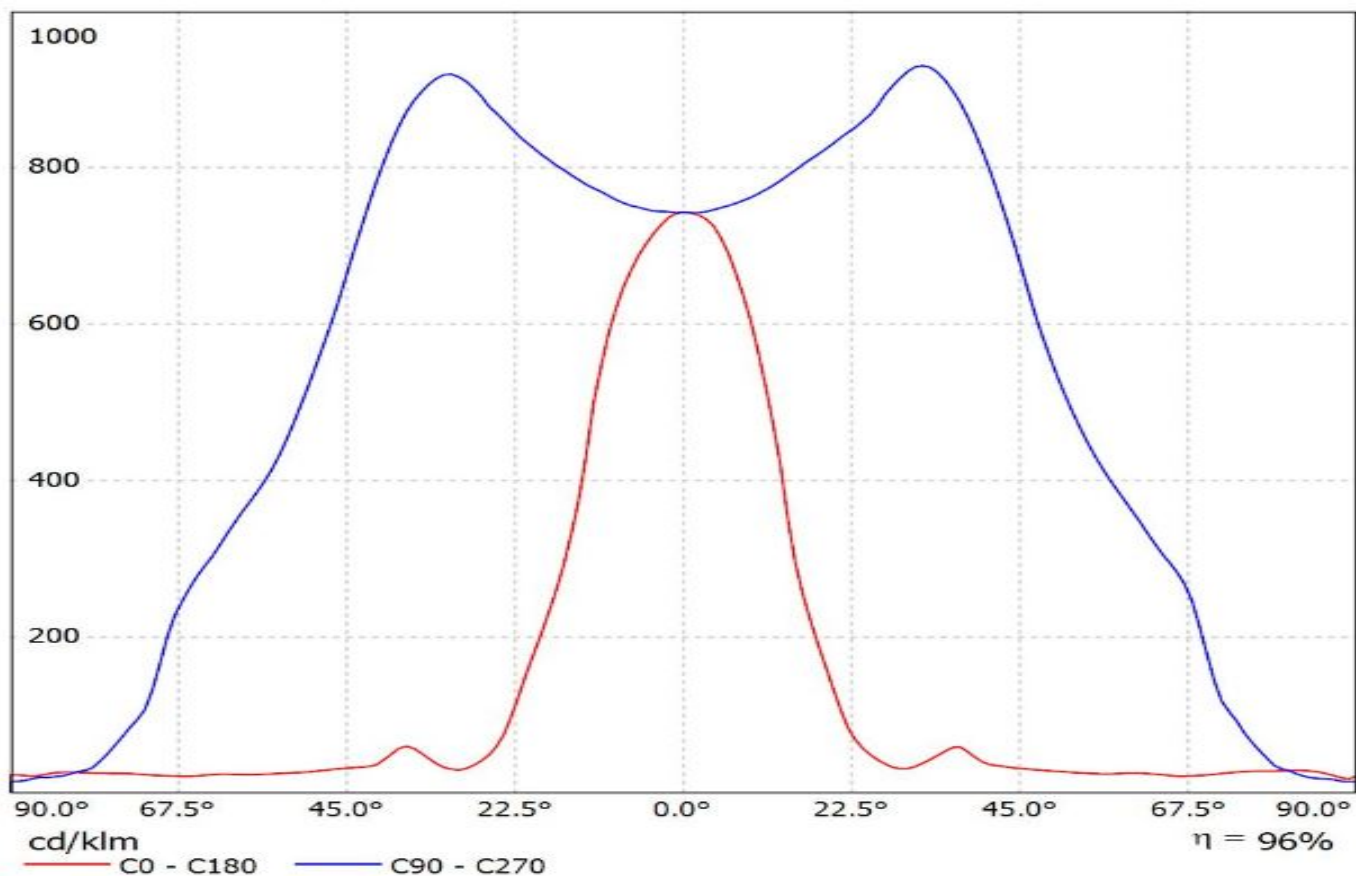

Luminaire: Ledil C13749_HB-2x2-O_(H35C1)

Lamps: 1 x LG_H35C1_2x2_477.216lm@250mA_P=2.87475W_I=0.250A

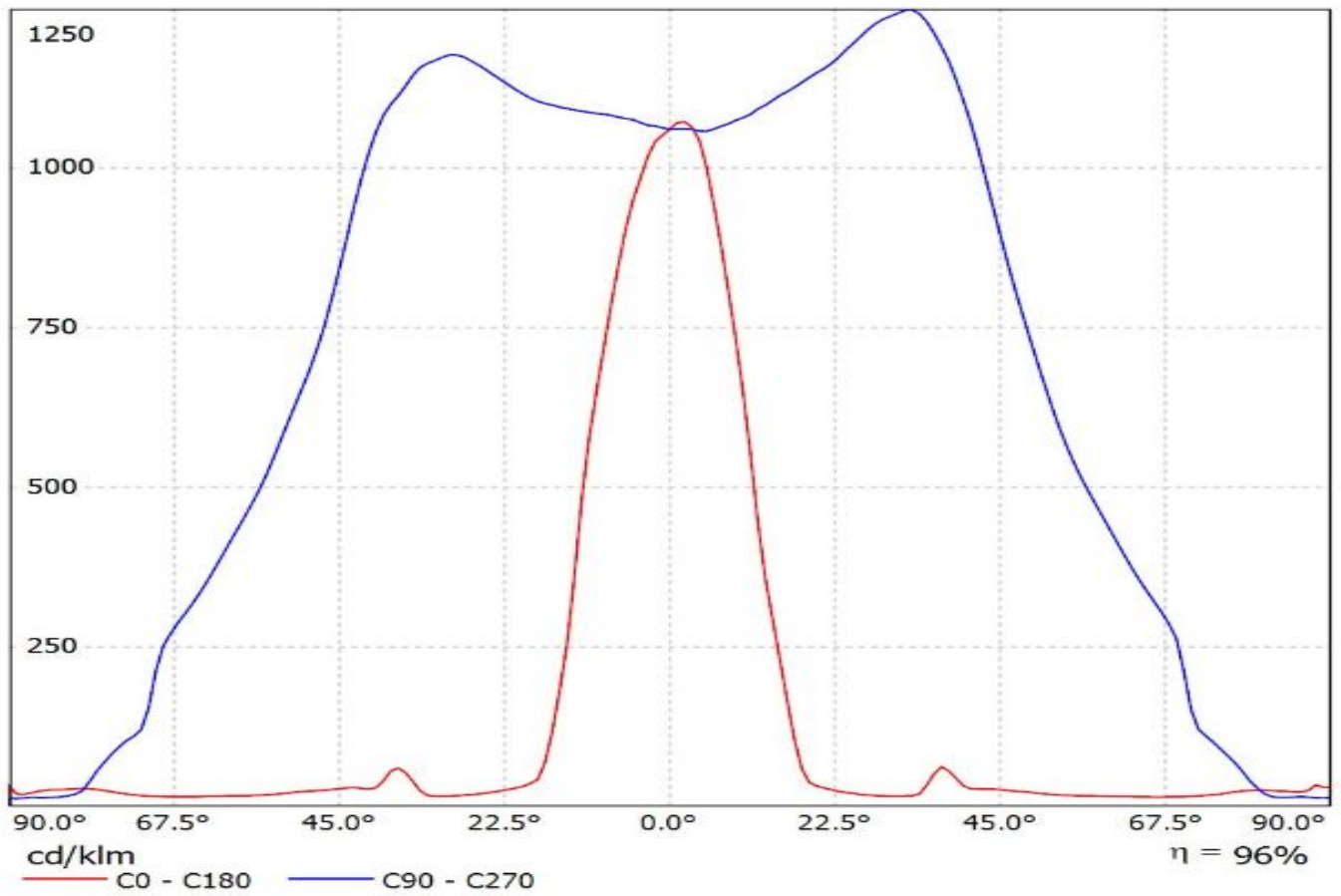

Luminaire: LEDil Oy C13749_HB-2X2-O_(Luxeon_T) Efficiency=94%
Lamps: 1 x Luxeon T (LXH8-FW30-3) 289lm @ 250mA CCT=3200K P=2.8W I=250mA

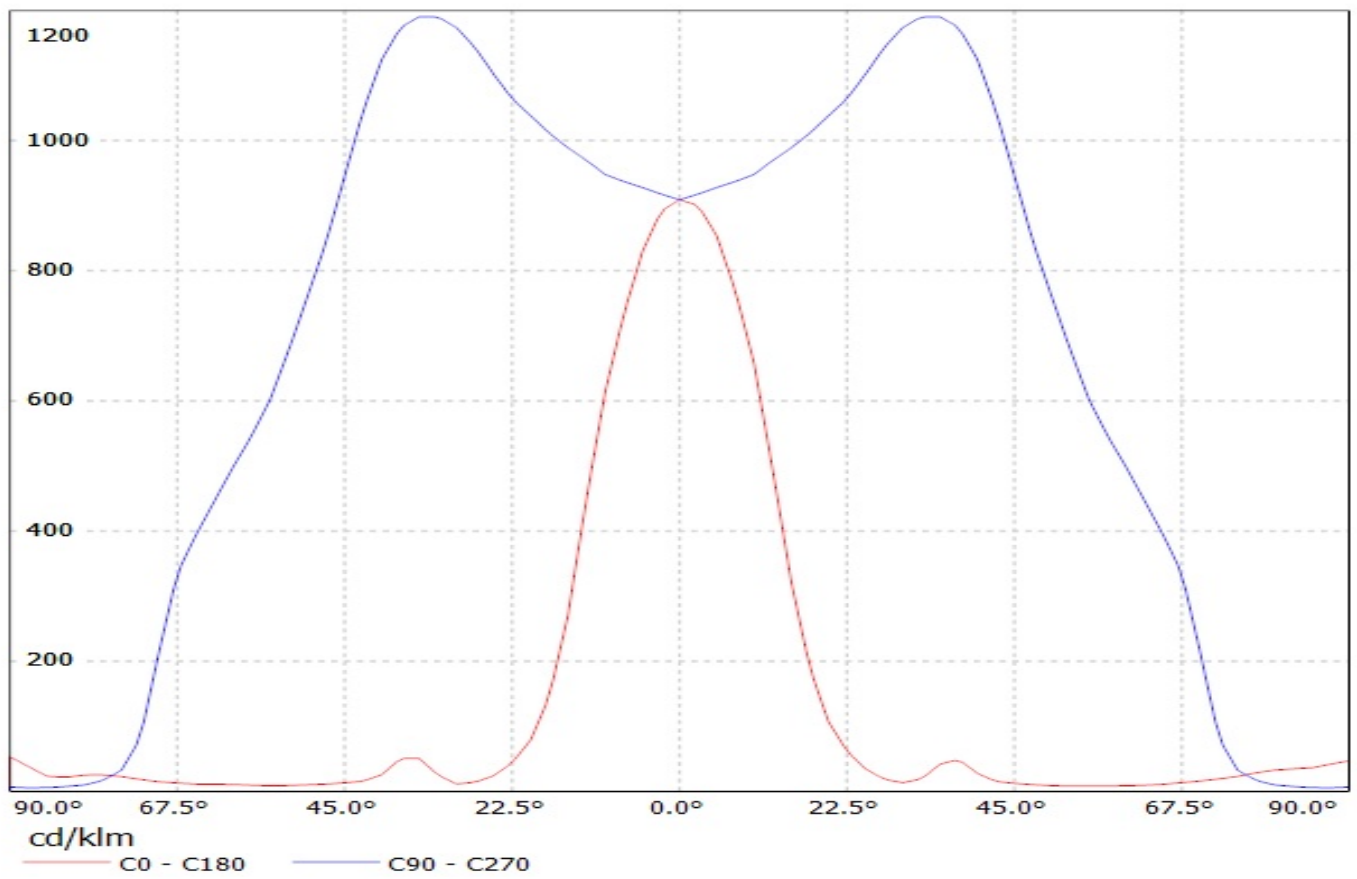

Luminaire: LEDil Oy C13749_HB-2X2-O_(Luxeon_MZ)
Lamps: 1 x Philips Lumileds Luxeon MZ (413.59lm @ 250mA) P=2.7W I=250mA

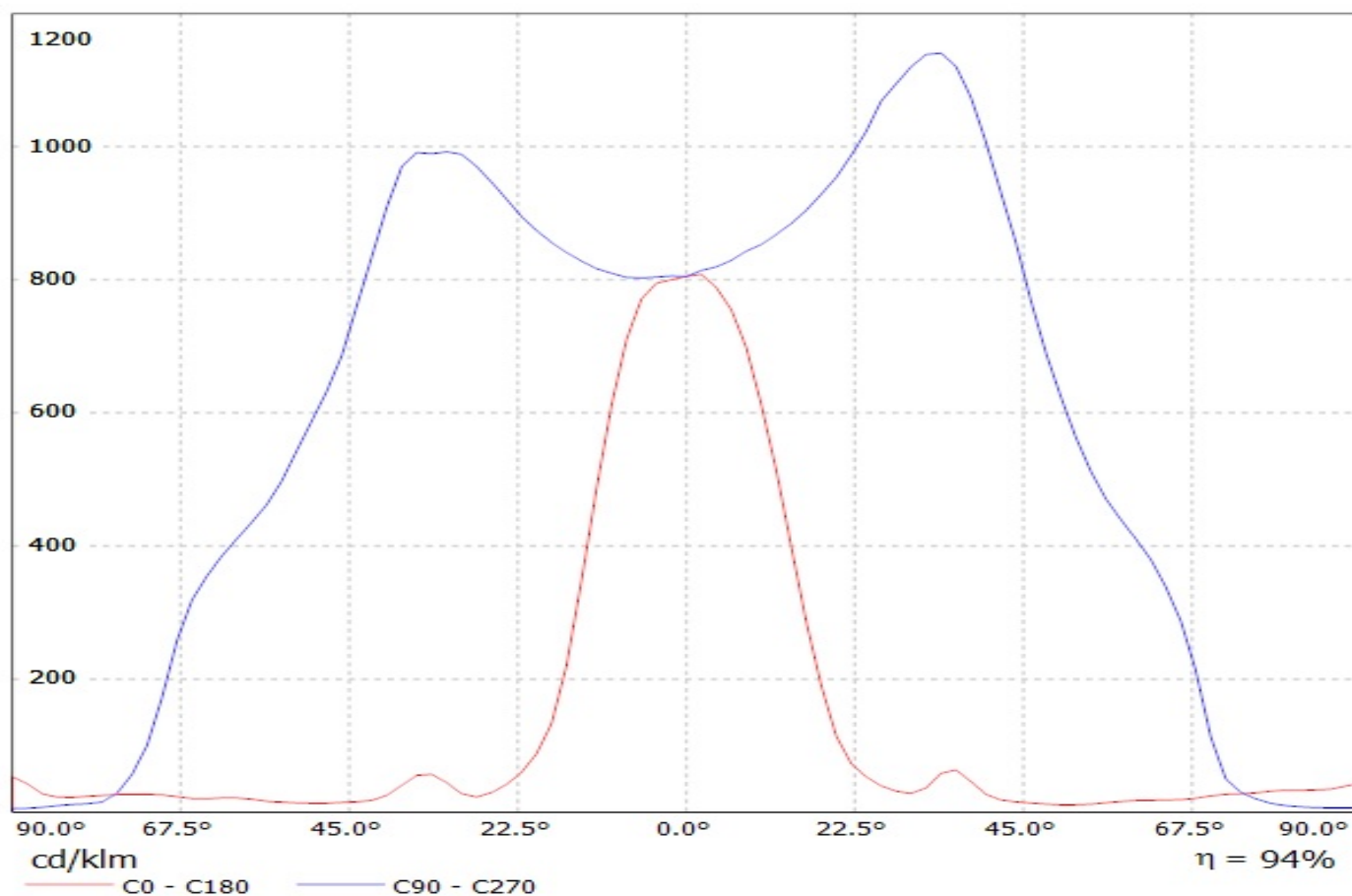

Luminaire: LEDiL Oy C13749_HB-2X2-O_(Luxeon_TX)
Lamps: 1 x Luxeon_TX_2x2_305lm@250mA_P=2.79451W_I=249.8mA

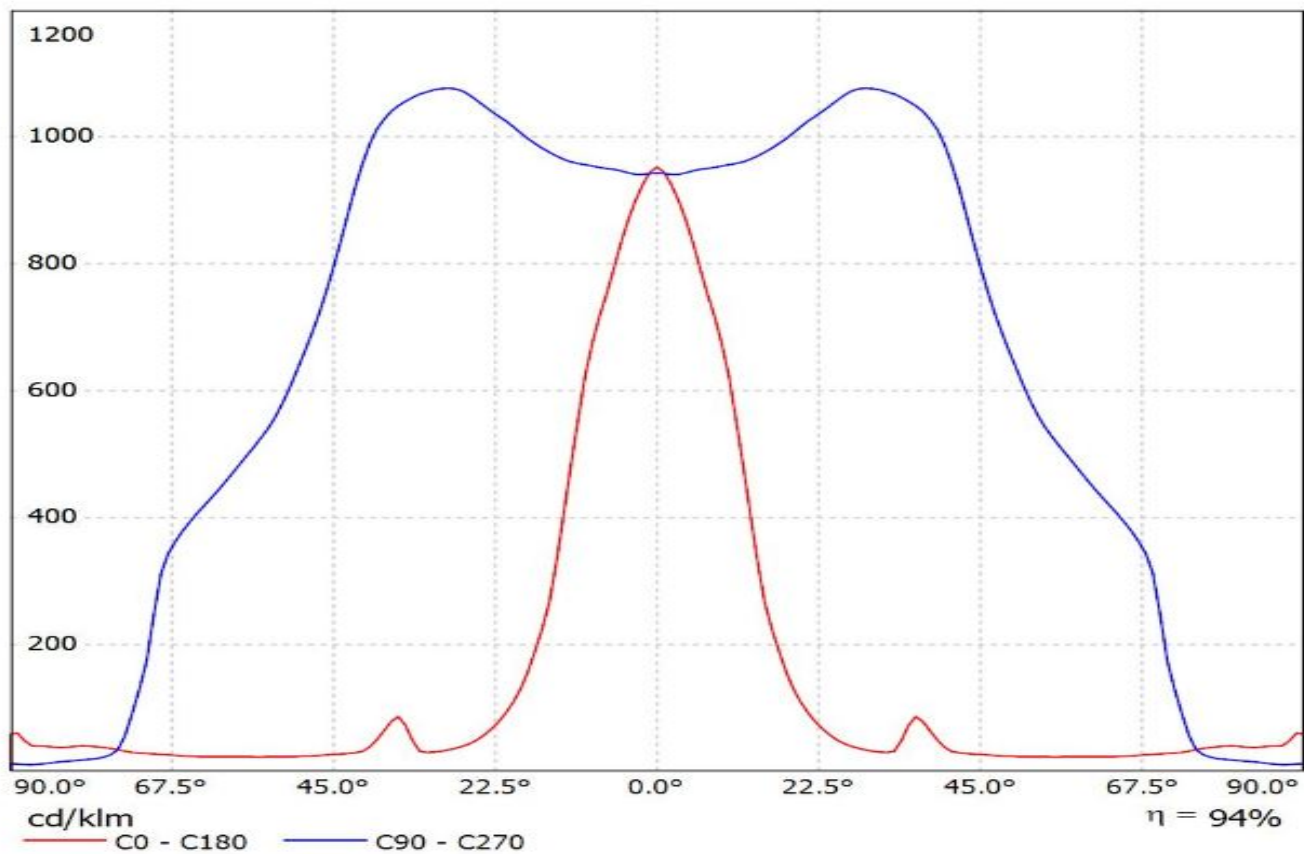

Luminaire: LEDiL Oy C13749_HB-2X2-O_(Luxeon_5050)
Lamps: 1 x Luxeon_5050_2x2_1270.76lm@80mA_CCT=5700K_P=7.35815W_I=0.080A_70CRI

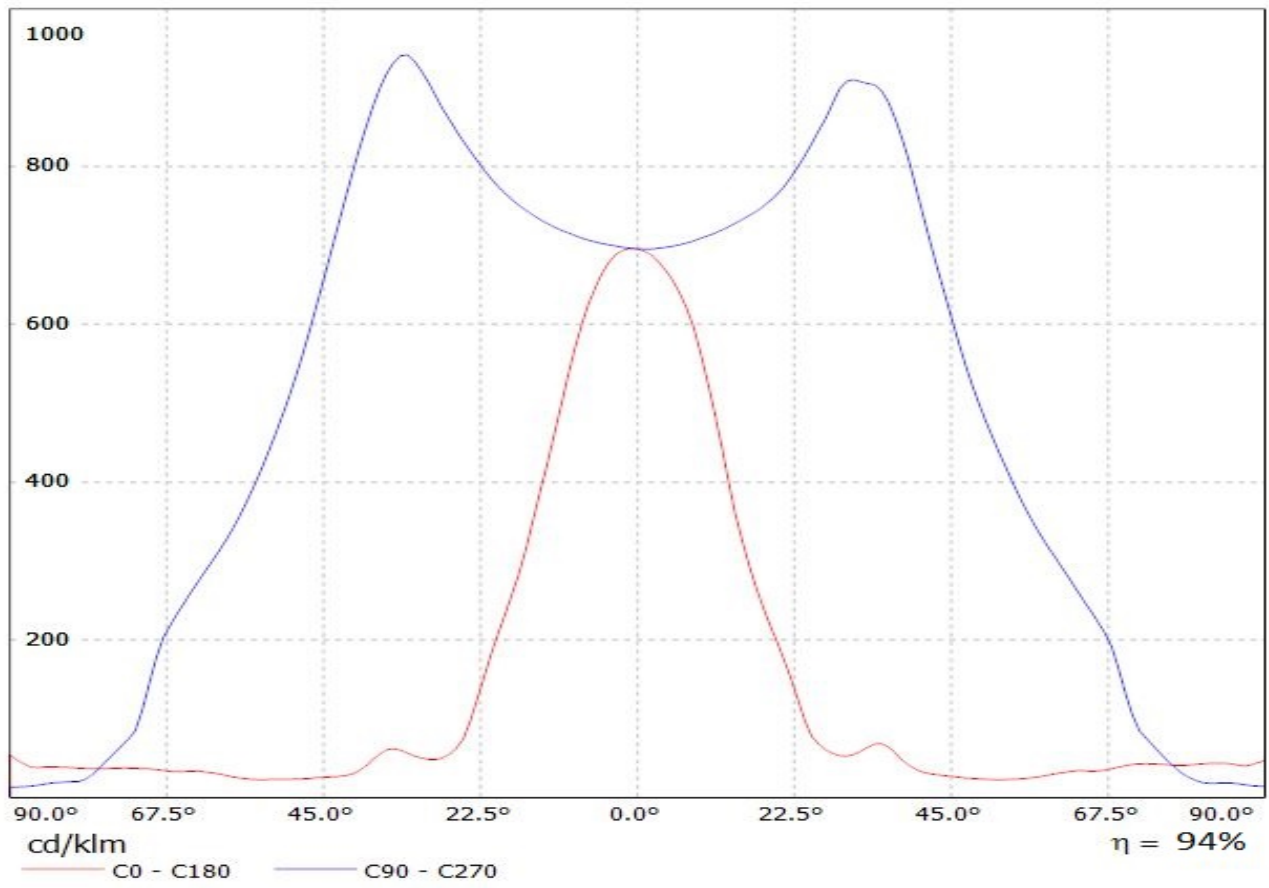

Luminaire: LEDil Oy C13749_HB-2X2-O_(NVSxx19B) Efficiency=94%
Lamps: 1 x Nichia NCSxx19B (NVSL219BE) 315lm @ 250mA CCT=3100K P=2.9W I=250mA

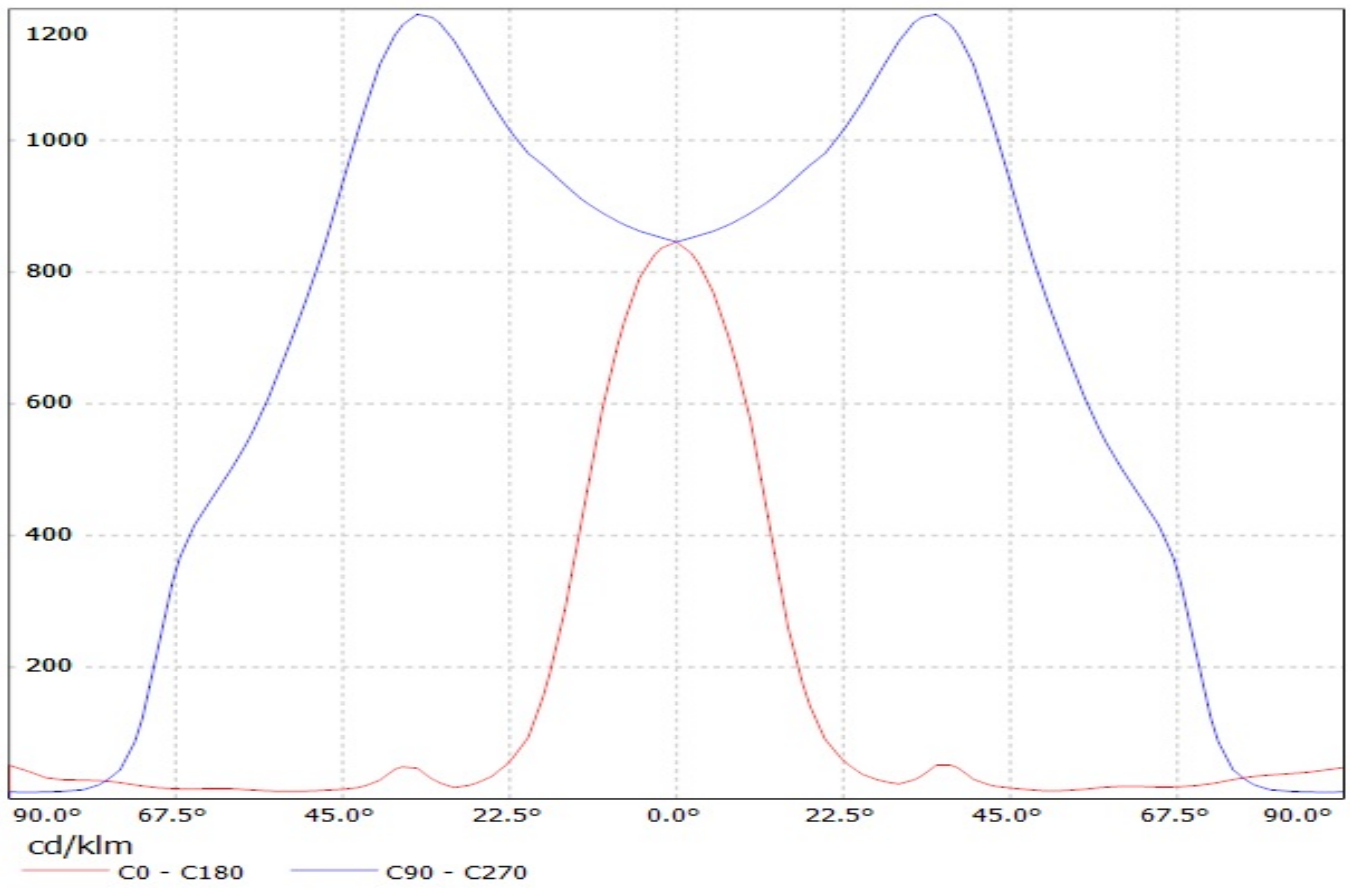

Luminaire: LEDil Oy C13749_HB-2X2-O_(NCSxx19B) Efficiency=94%
Lamps: 1 x Nichia NCSxx19B (NCSW119BE) 425lm @ 250mA CCT=5400K P=3.1W I=250mA

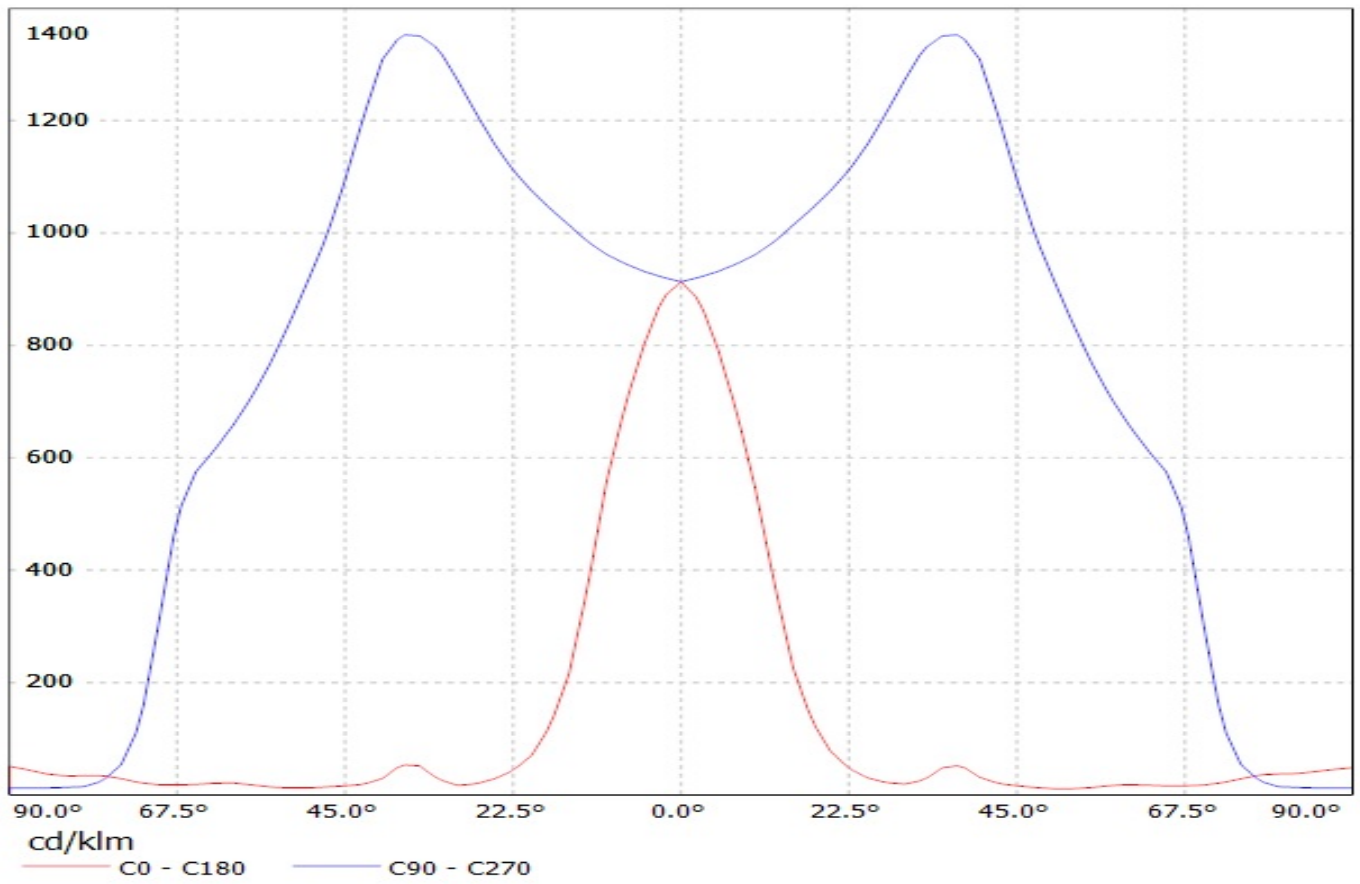

Luminaire: LEDiL Oy C13749_HB-2X2-O_(NWSL229AE)

Lamps: 1 x Nichia_2X2_NWSL229AE_476.548lm@250mA_P=2.7515W_I=0.250A

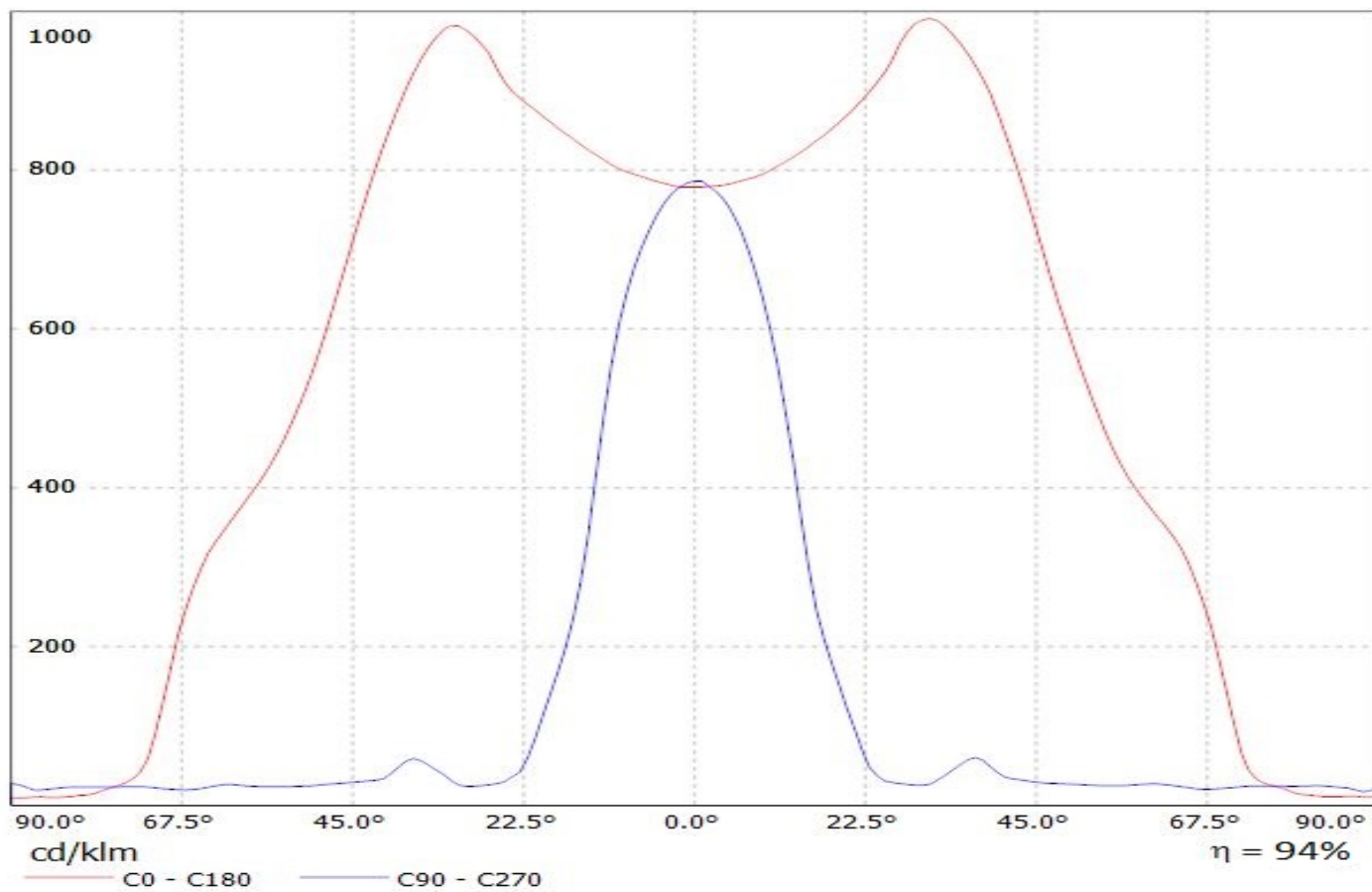

Luminaire: LEDiL Oy C13749_HB-2X2-O_(NVSW3x9A)

Lamps: 1 x Nichia_NVSW3x9A_(sm405/R70)_483.482lmP=2.75904W_I=0.250A

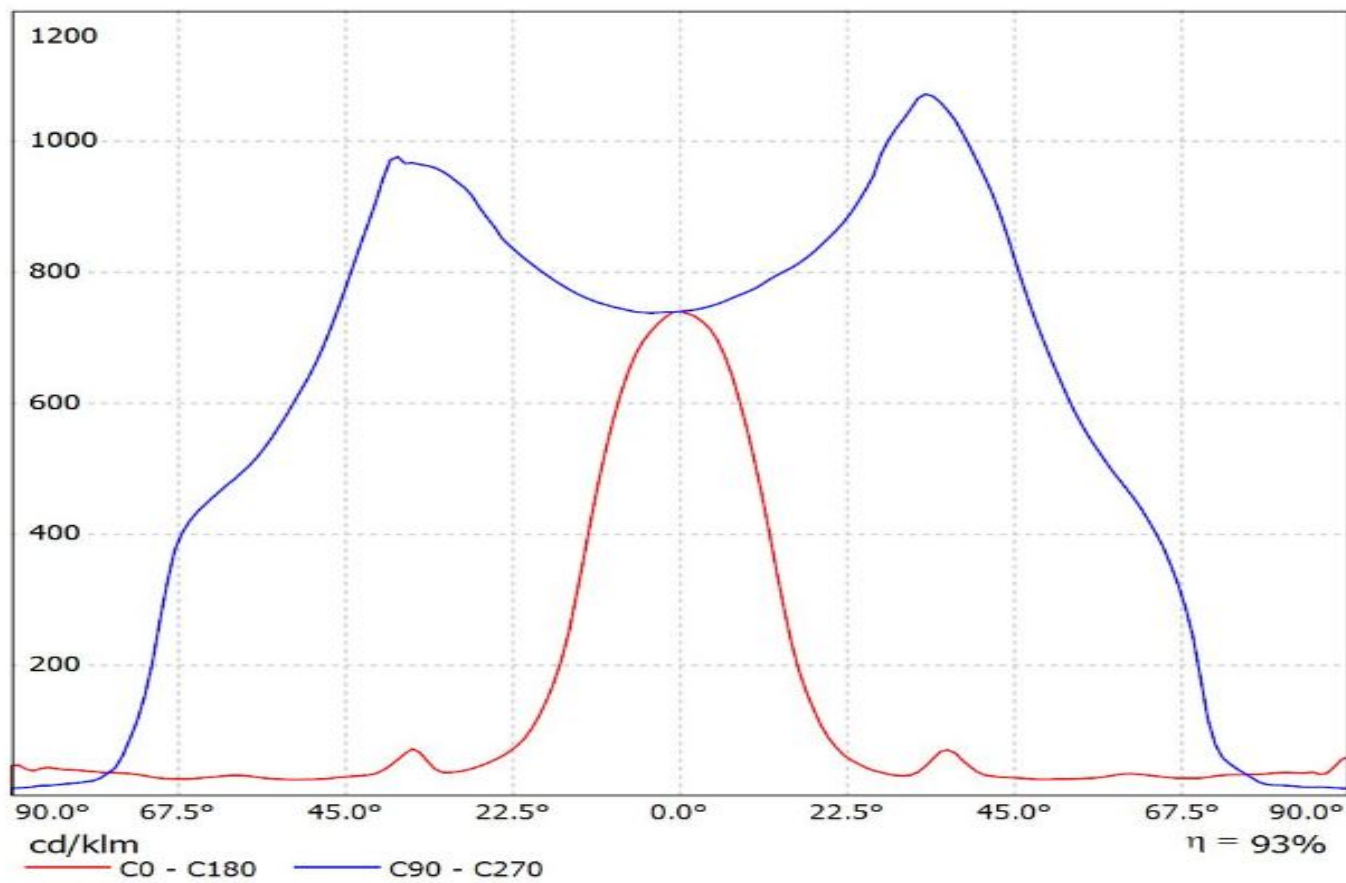

Luminaire: LEDiL Oy C13749_HB-2X2-O_(E21A_2X2)
Lamps: 1 x Nichia_E21A_2X2_451.614lm@250mA_P=2.8045W_I=0.250A

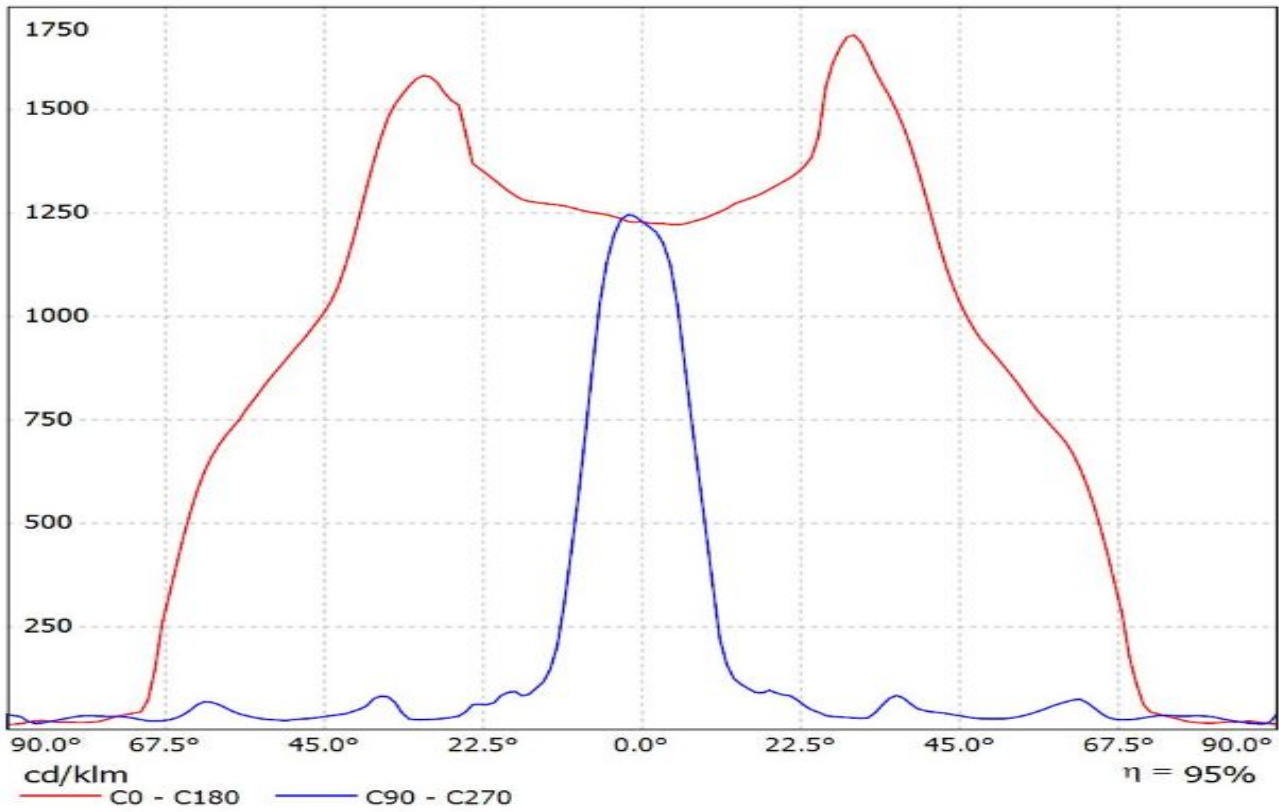

Luminaire: LEDiL Oy C13749_HB-2X2-O_(NVSW319AE)
Lamps: 1 x Nichia_NVSW319AE_499.093lm@250mA_P=2.79052W_I=0.25A

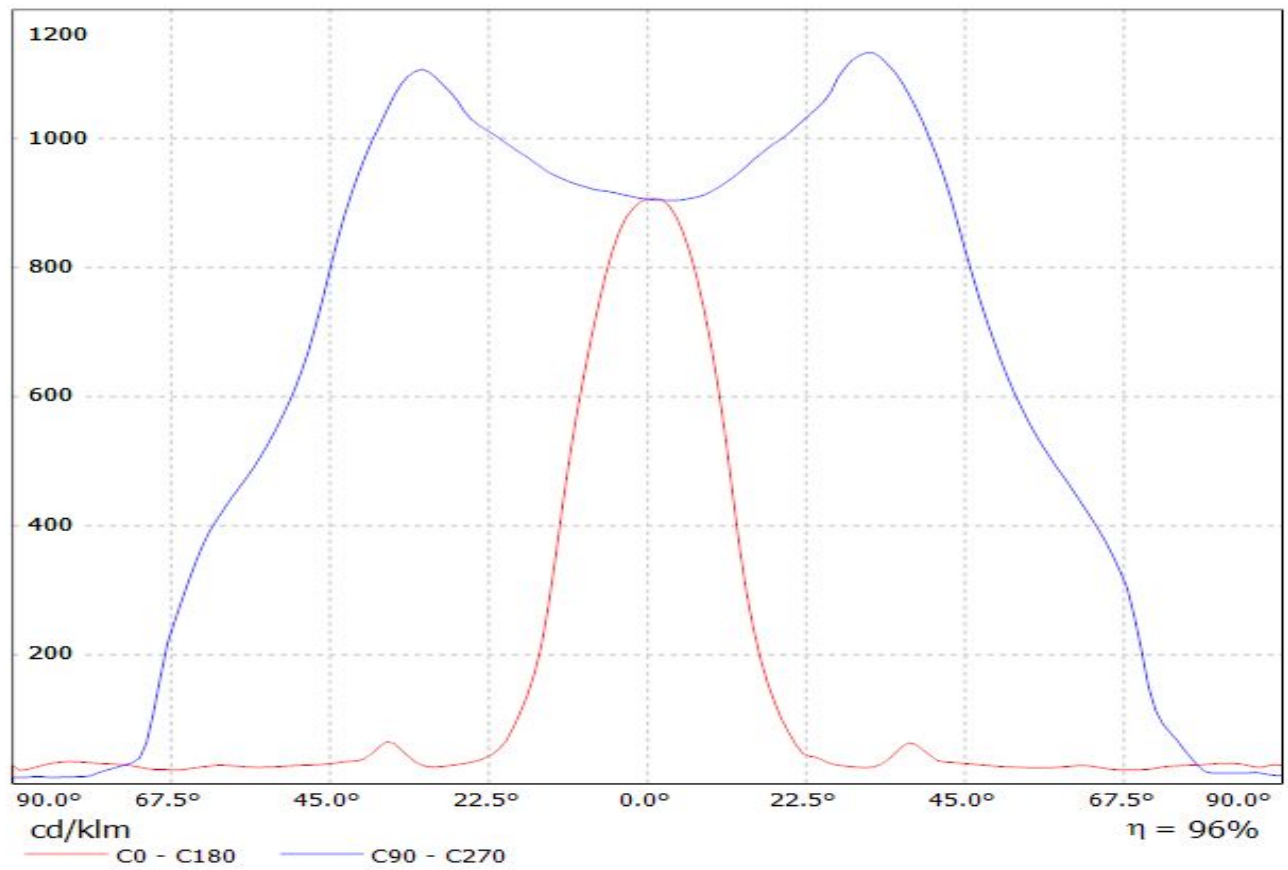

Luminaire: LEDiL Oy C13479_HB-2x2-O_(SQ-PC)

Lamps: 1 x OSRAM_OSLON_SQUARE_PC_2x2_(GWCSSRM1.PC)_414.854lm@250mA_P=2.8626W_CCT=5201K_I=249.9mA

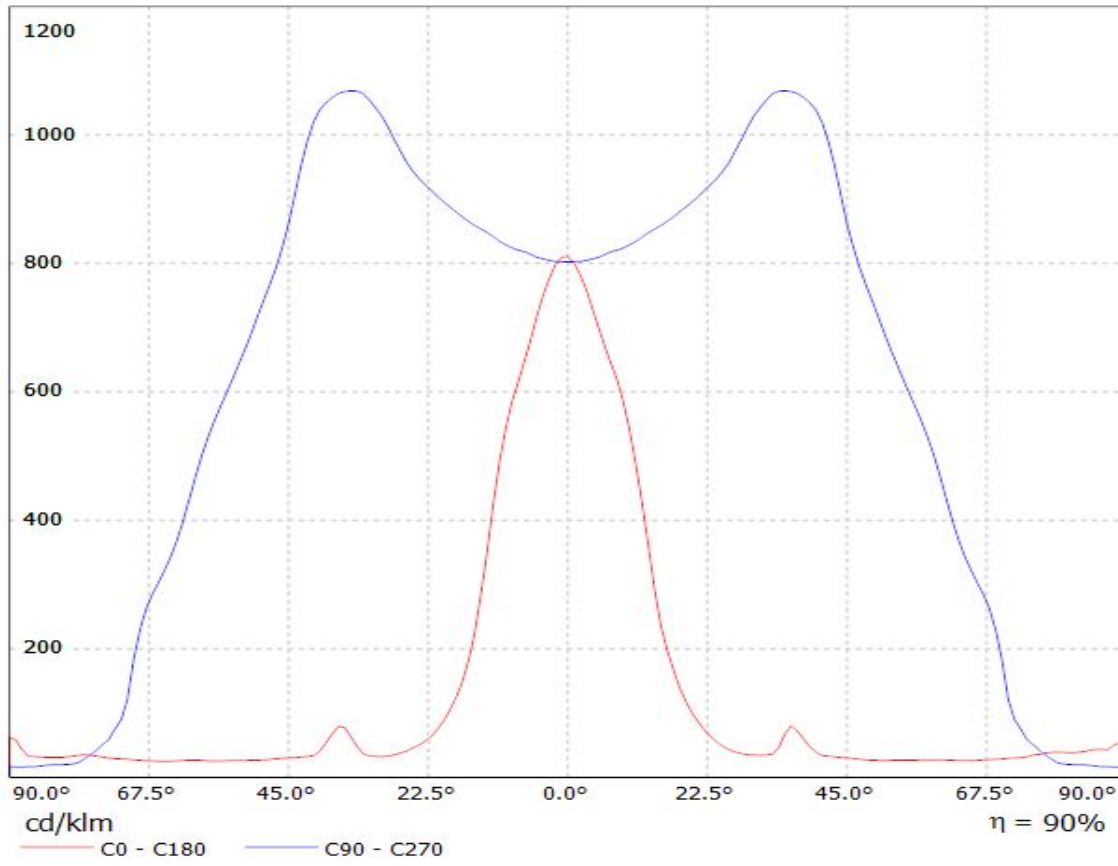

Luminaire: Ledil Oy C13749_HB-2X2-O_(Duris_P8)_SIMULATED
Lamps: 1 x Osram Duris P8

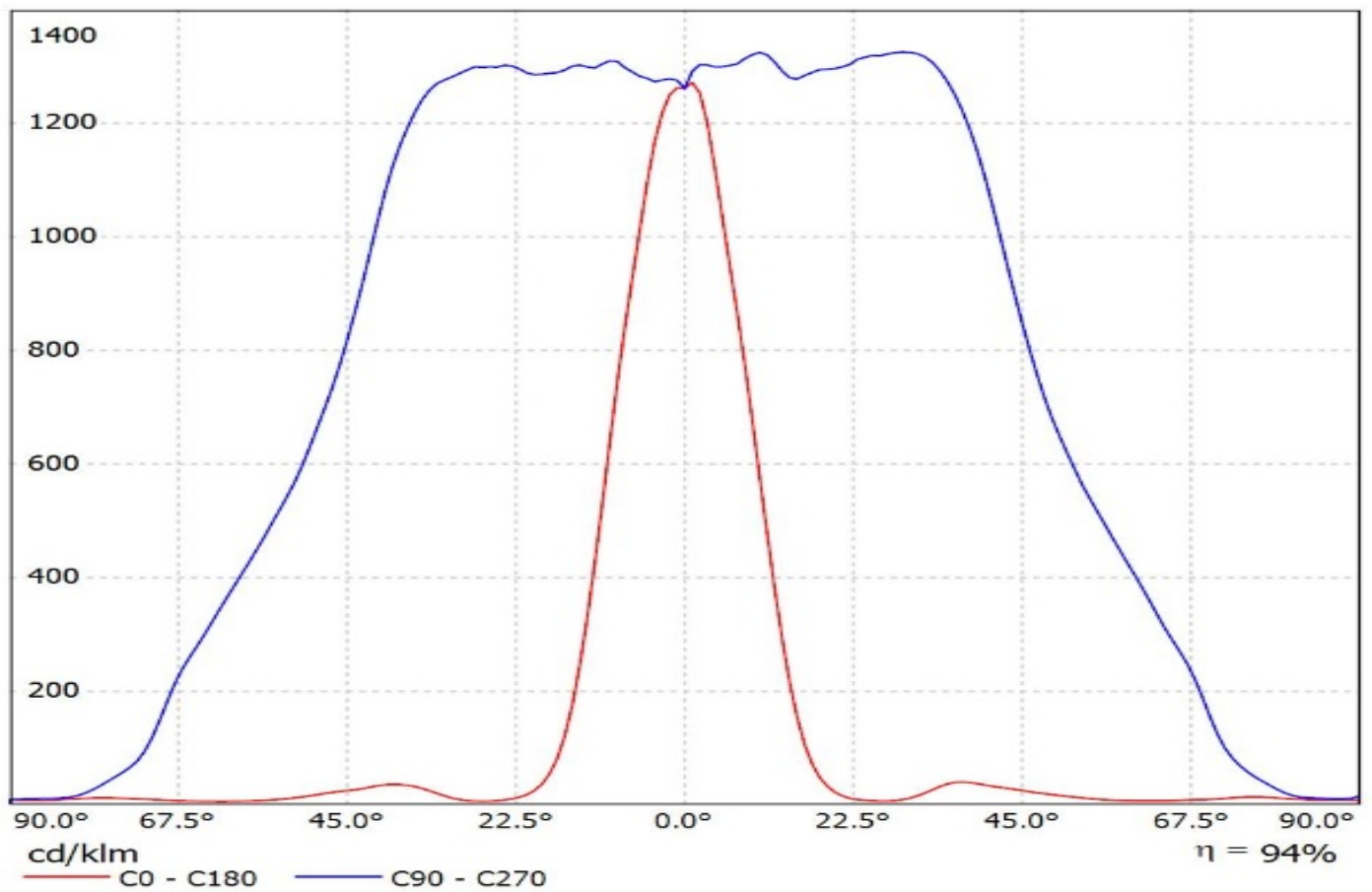

Luminaire: Ledil C13749_HB-2X2-O_(Fortimo_FastFlex_LED_board_2x8/740_DA_G3)
Lamps: 1 x Fortimo_FastFlex_LED_board_2x8/740_DA_G3_1828.23lm@250mA_P=11.667W_I=0.25A

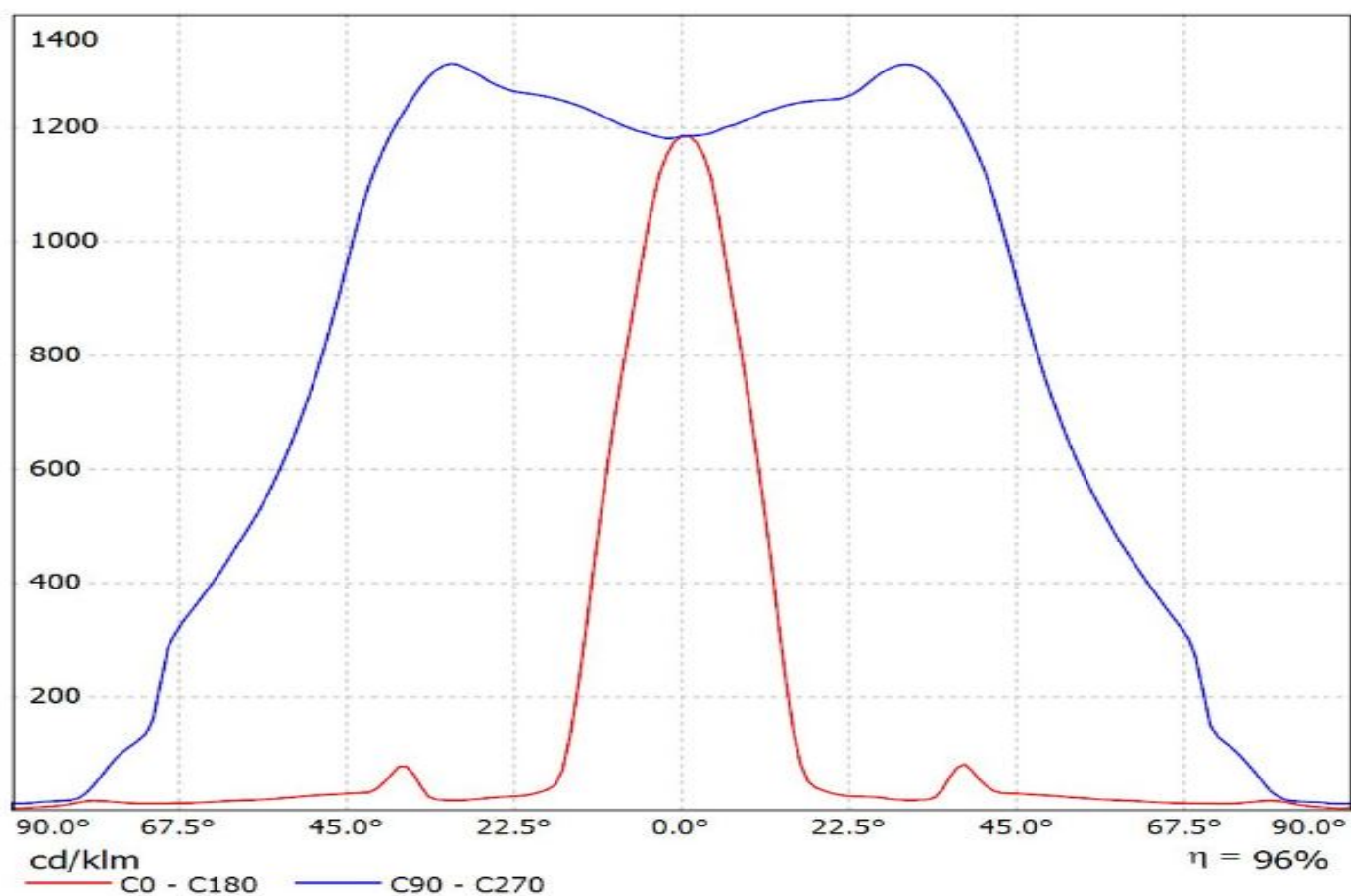

Luminaire: LEDiL Oy C13749_HB-2X2-O_(LH351Z)

Lamps: 1 x SAMSUNG_LH351Z_2x2_361.9lm@250mA_P=2.86371W_I=249.8mA

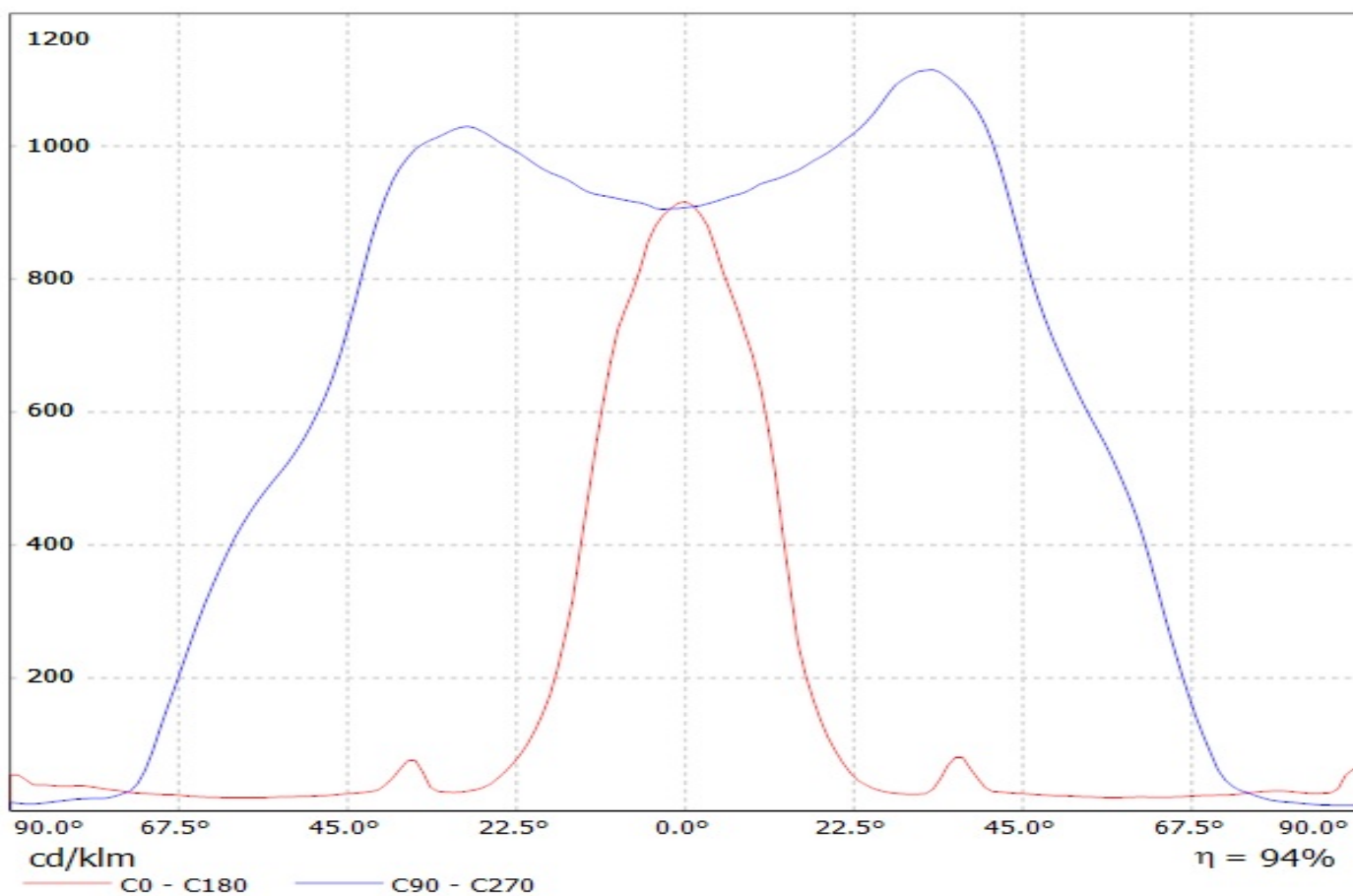

Luminaire: Ledil C13749_HB-2X2-O_(LH351B)

Lamps: 1 x Samsung_LH351B_2x2_444.178lm@250mA_P=2.8535W_I=0.25A

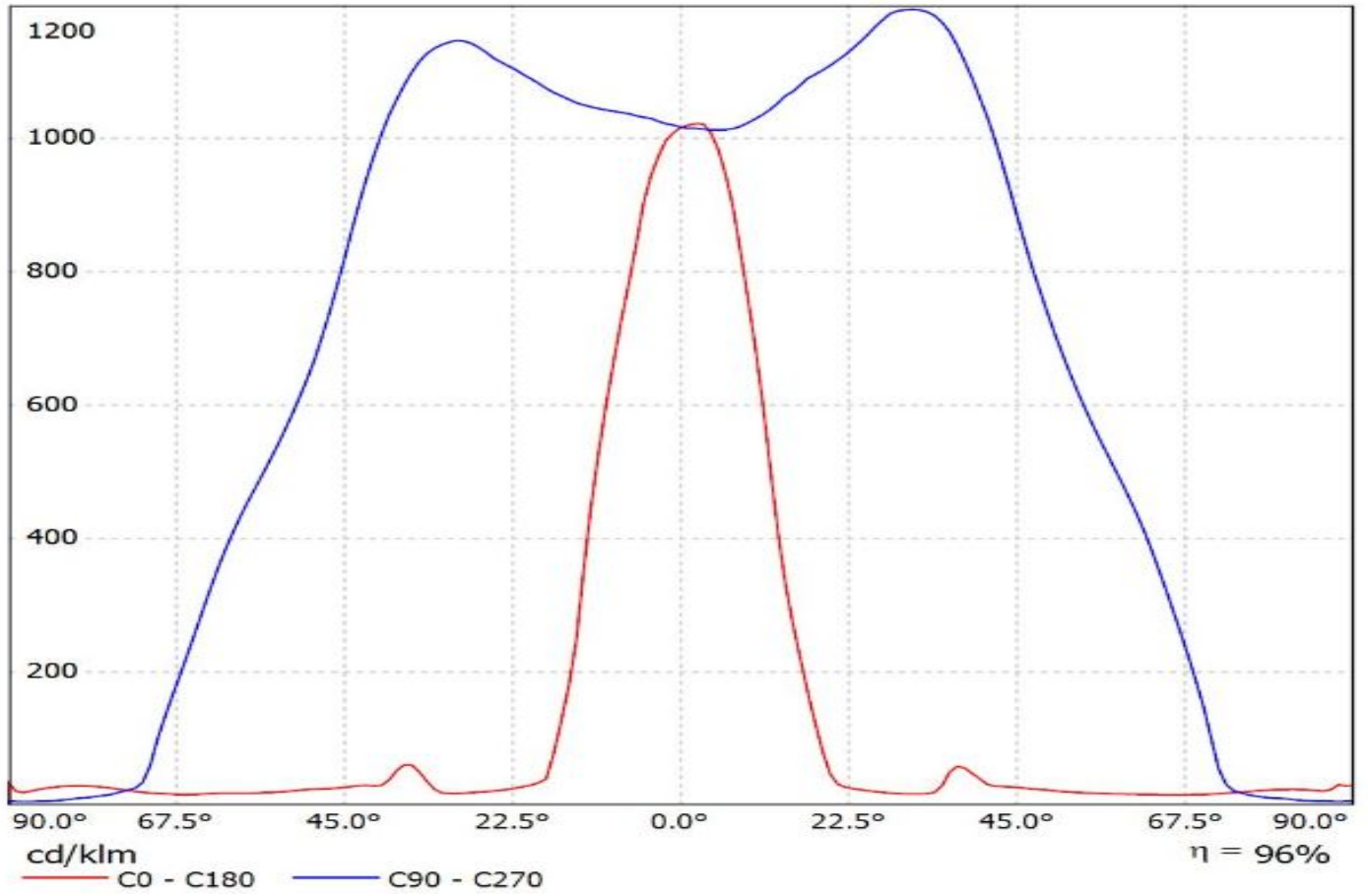

Luminaire: Ledil C13749_HB-2X2-O_(LH351D)

Lamps: 1 x Samsung_LH351D_536.957lm@250mA_P=2.7695W_I=0.250A

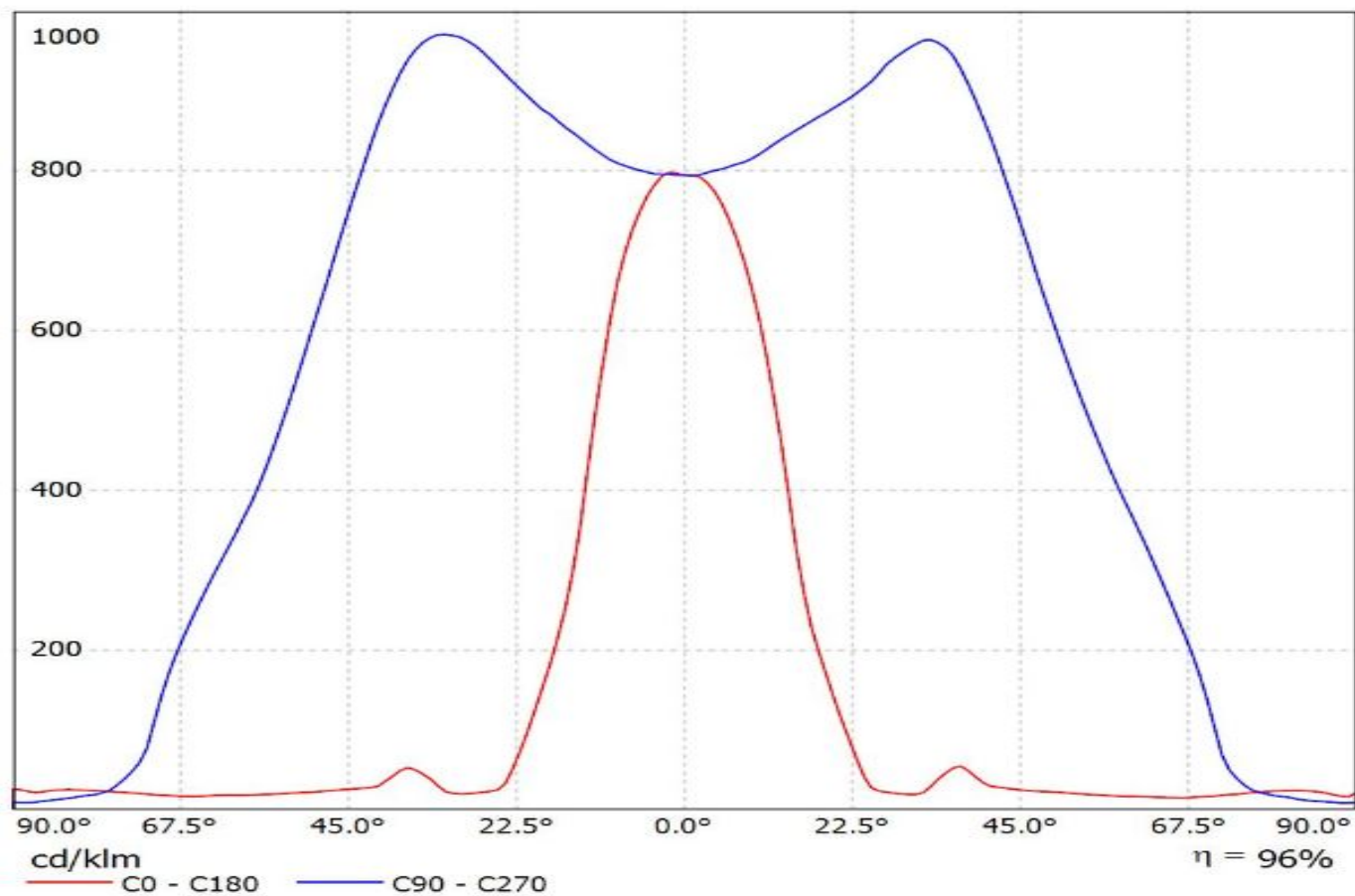

Luminaire: Ledil Oy C13749_HB-2X2-O_(Z5M2)_SIMULATED
Lamps: 1 x Seoul Z5M2 (SZ5-M2-W0-00)

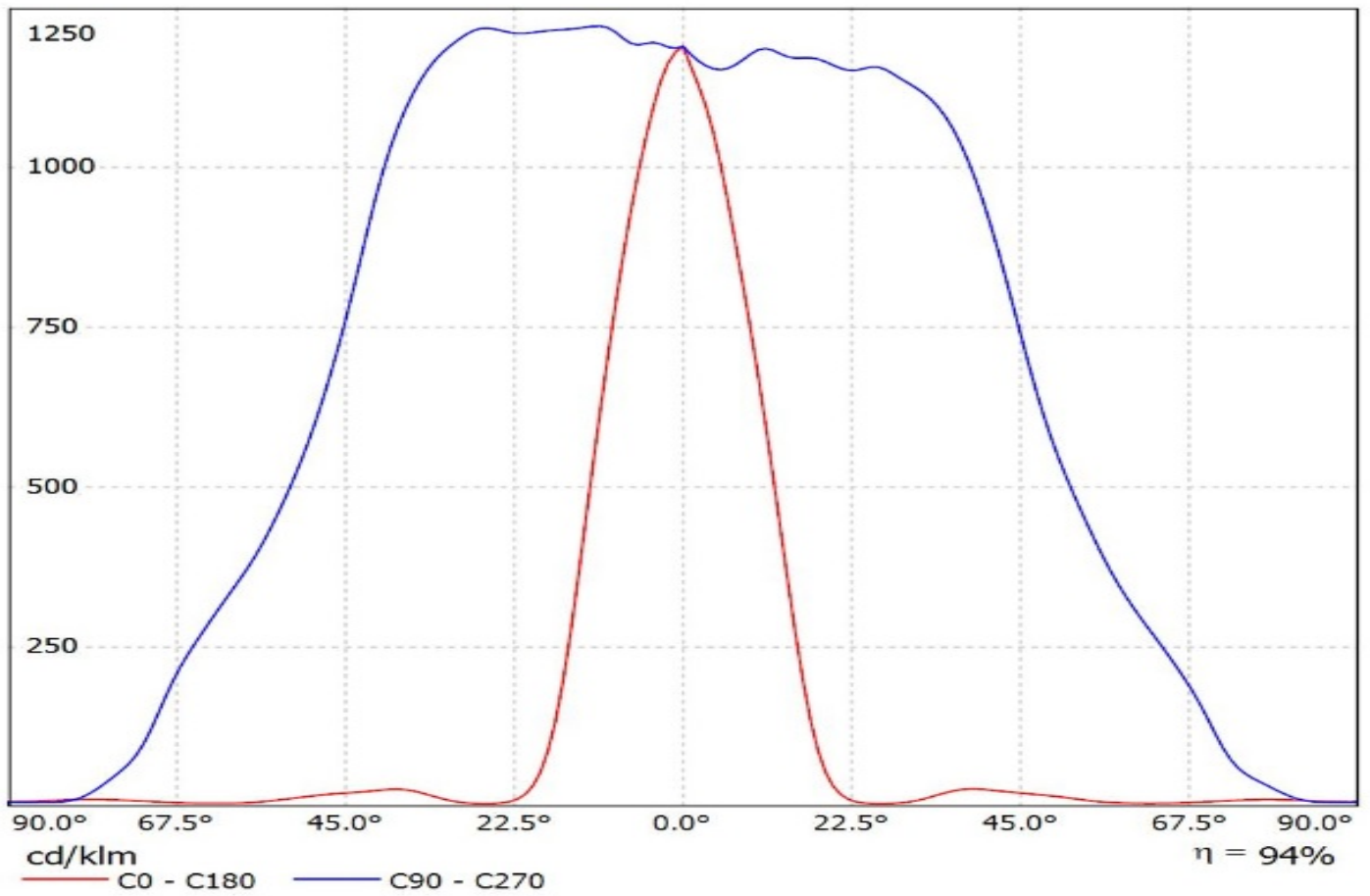

Luminaire: LEDiL Oy C13749_HB-2X2-O_(Tridonic_Module_RLE_G1)
Lamps: 1 x Tridonic_Module_RLE_G1_4576.03lm@700mA_P=32.0681W_I=0.700A

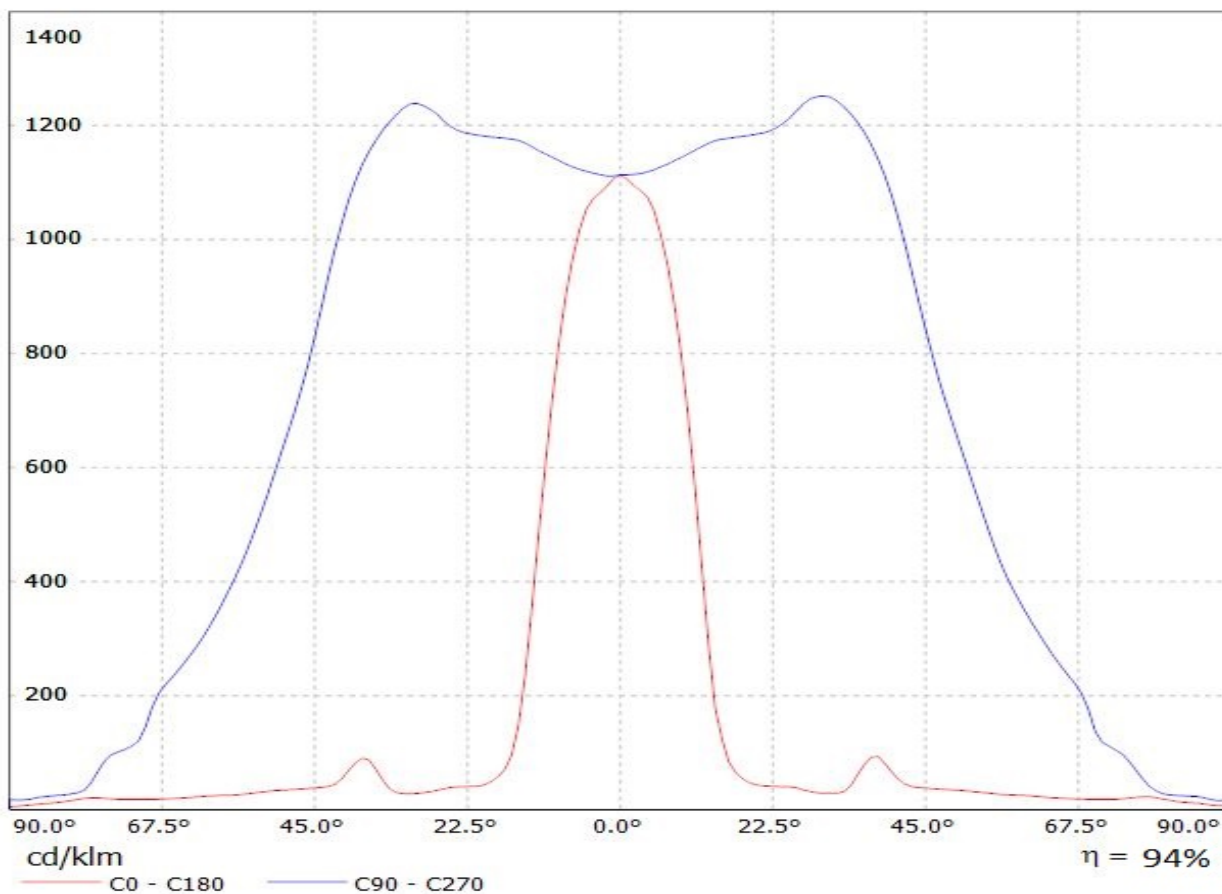

Luminaire: LEDiL Oy C13749_HB-2X2-O_(Tridonic_Module_RLE_G1)
Lamps: 1 x Tridonic_Module_RLE_G1_4576.03lm@700mA_P=32.0681W_I=0.700A

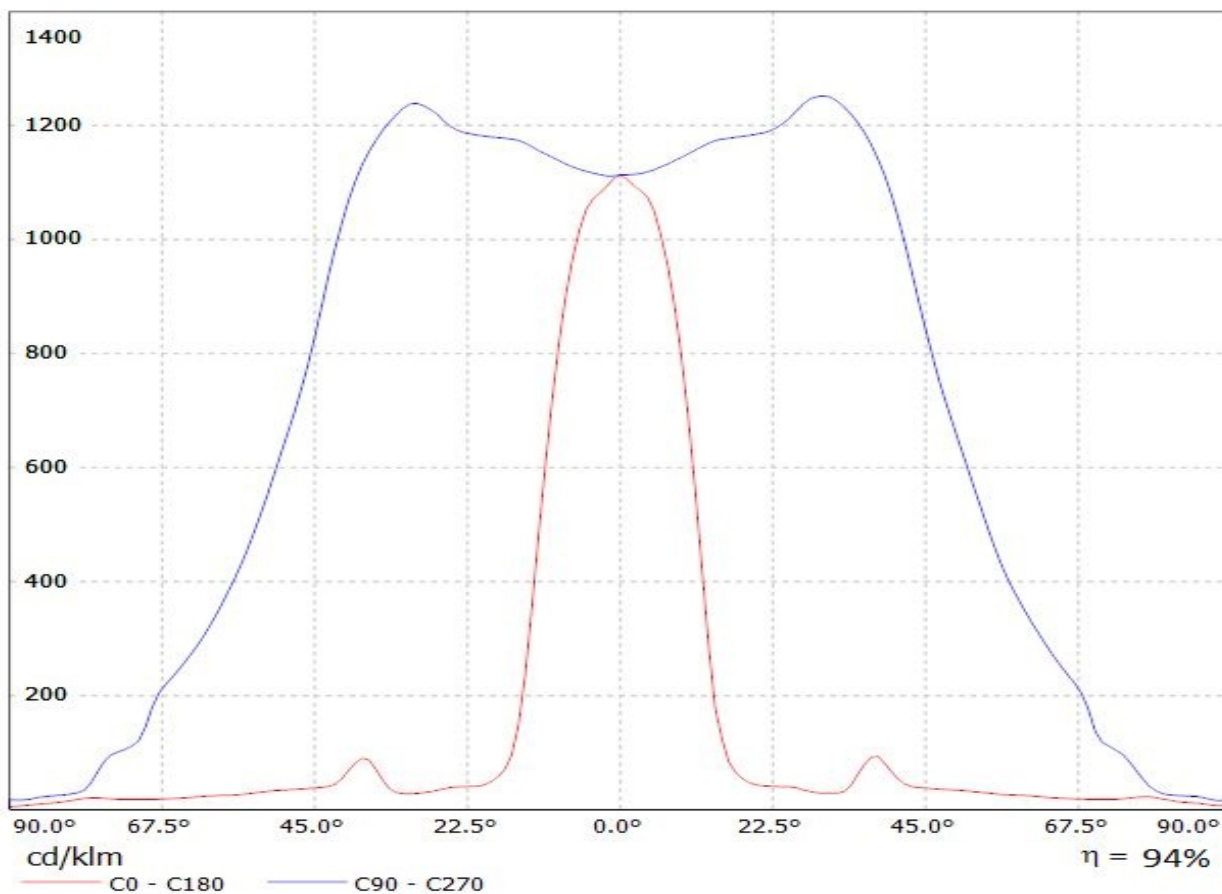

Luminaire: LEDiL Oy C13749_HB-2X2-O_(Tridonic_Module_RLE_G1)
Lamps: 1 x Tridonic_Module_RLE_G1_2288lm@700mA_P=16W_I=0.700A

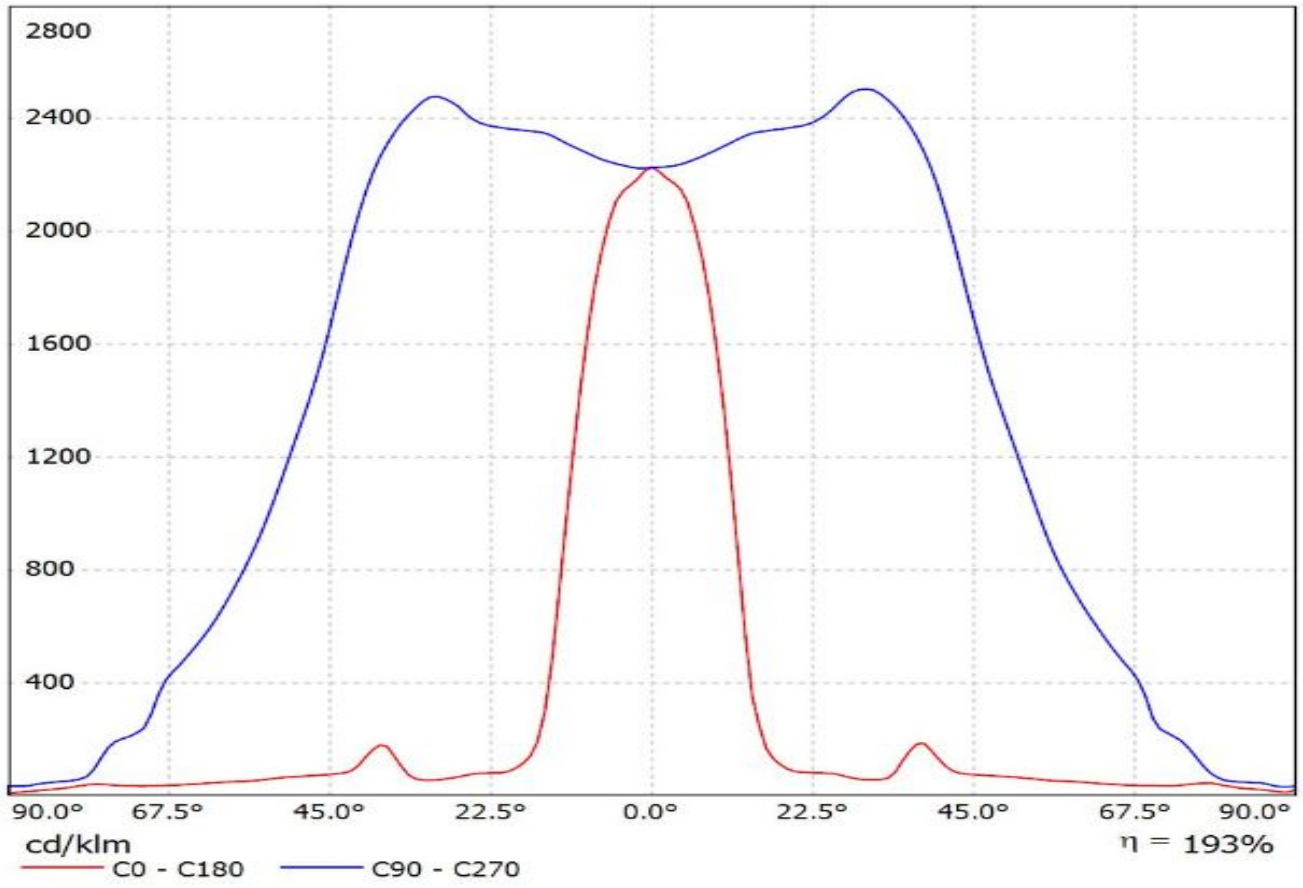

Luminaire: LEDiL Oy C13749_HB-2X2-O_(Tridonic_Module_RLE_G1)
Lamps: 1 x Tridonic_Module_RLE_G1_2288lm@700mA_P=16W_I=0.700A

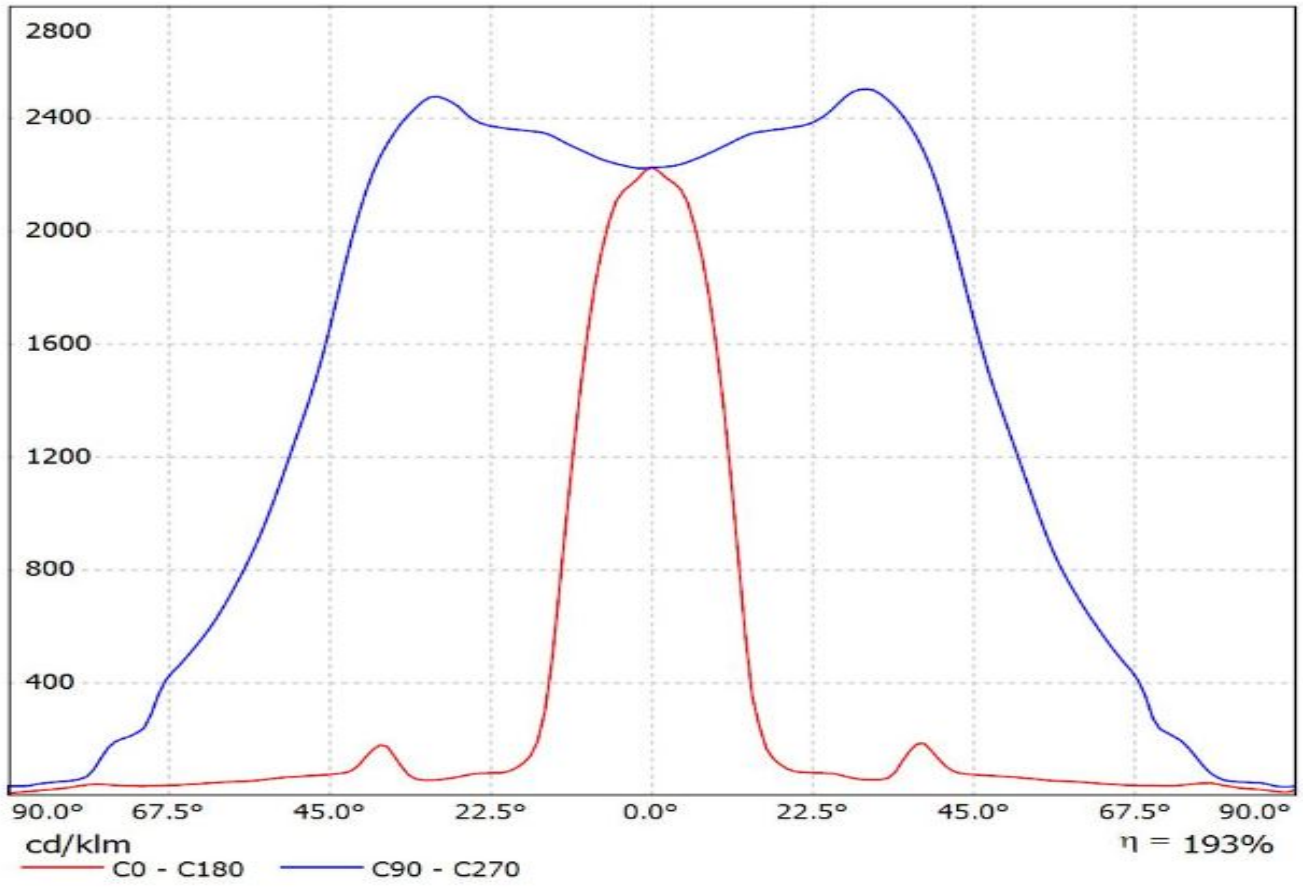

Luminaire: LEDil Oy C13749_HB-2X2-O_(XP-G2) Efficiency=94%

Lamps: 1 x Cree XP-G2 (XPGBWT-L1-000-00G51) 411lm @ 250mA CCT=7200K P=2.9W I=250mA

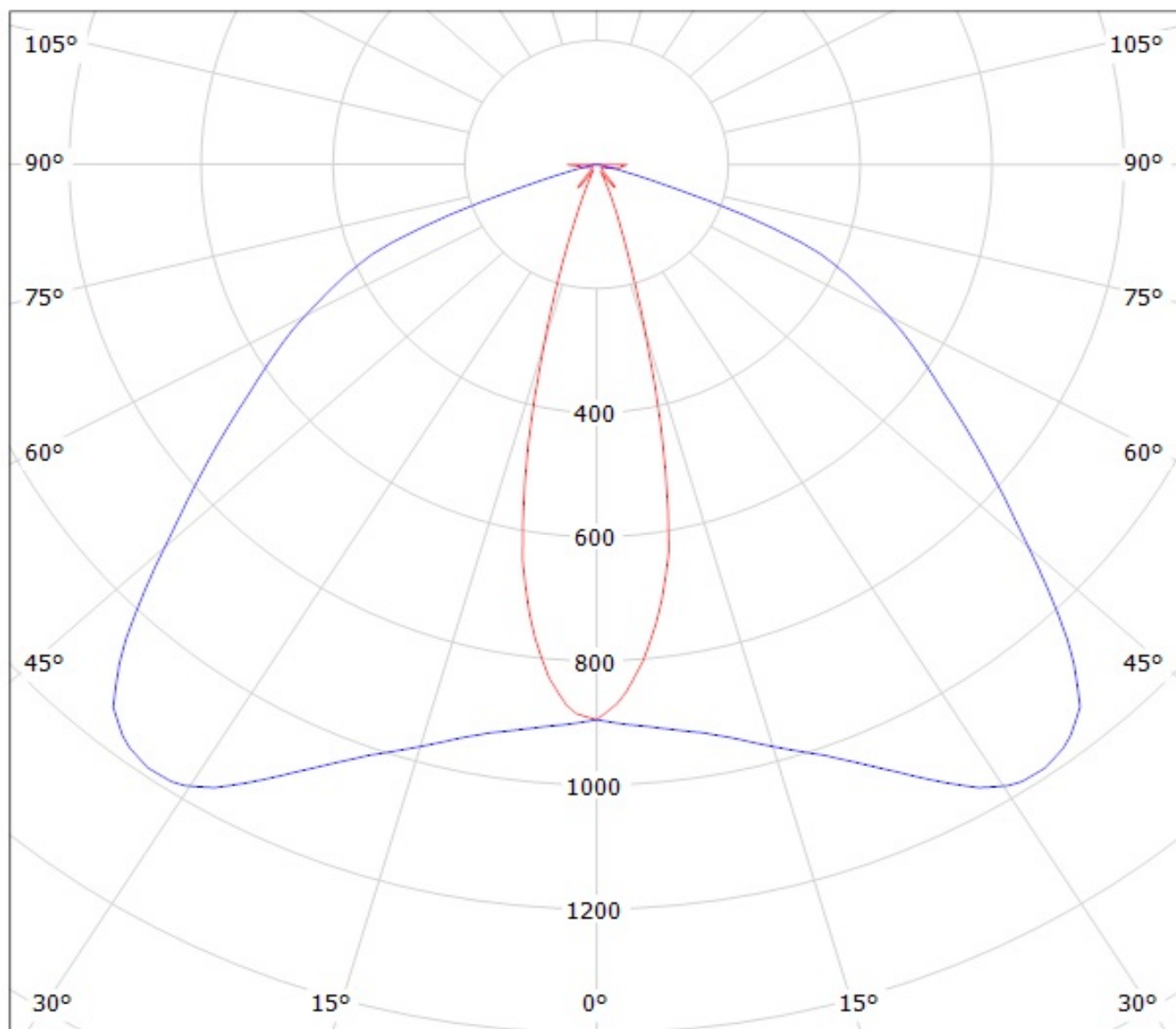

cd/klm

— C0 - C180

— C90 - C270

Luminaire: LEDil Oy C13749_HB-2X2-O_(XM-L2) Efficiency=94%
Lamps: 1 x Cree XM-L2 (XMLBWT-0-7B4-T30-0L-0001) 356lm @ 250mA CCT=3200K P=2.8W I=250mA

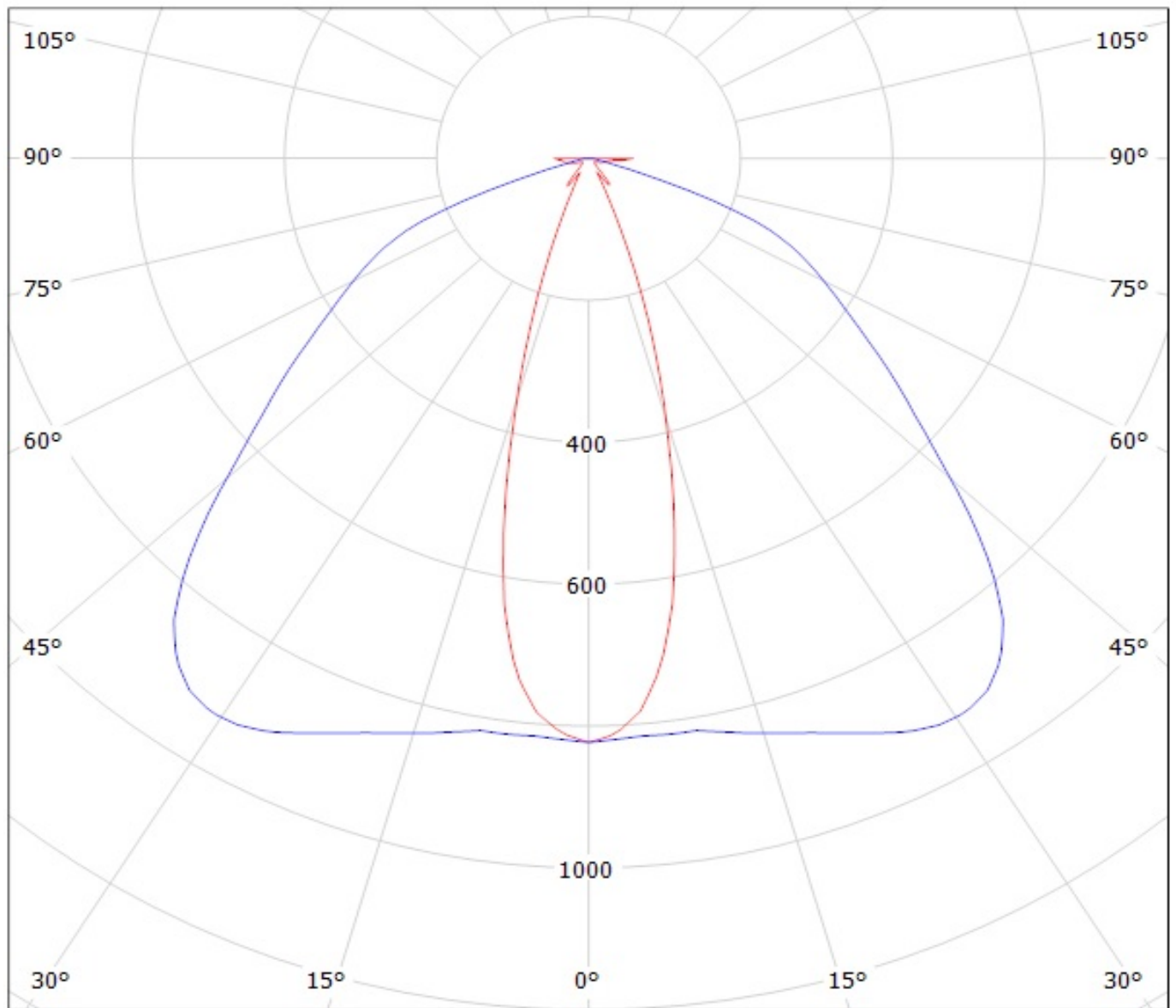

cd/klm

— C0 - C180 — C90 - C270

Luminaire: Ledil Oy C13749_HB-2X2-O_(XP-G)_SIMULATED
Lamps: 1 x Cree XP-G

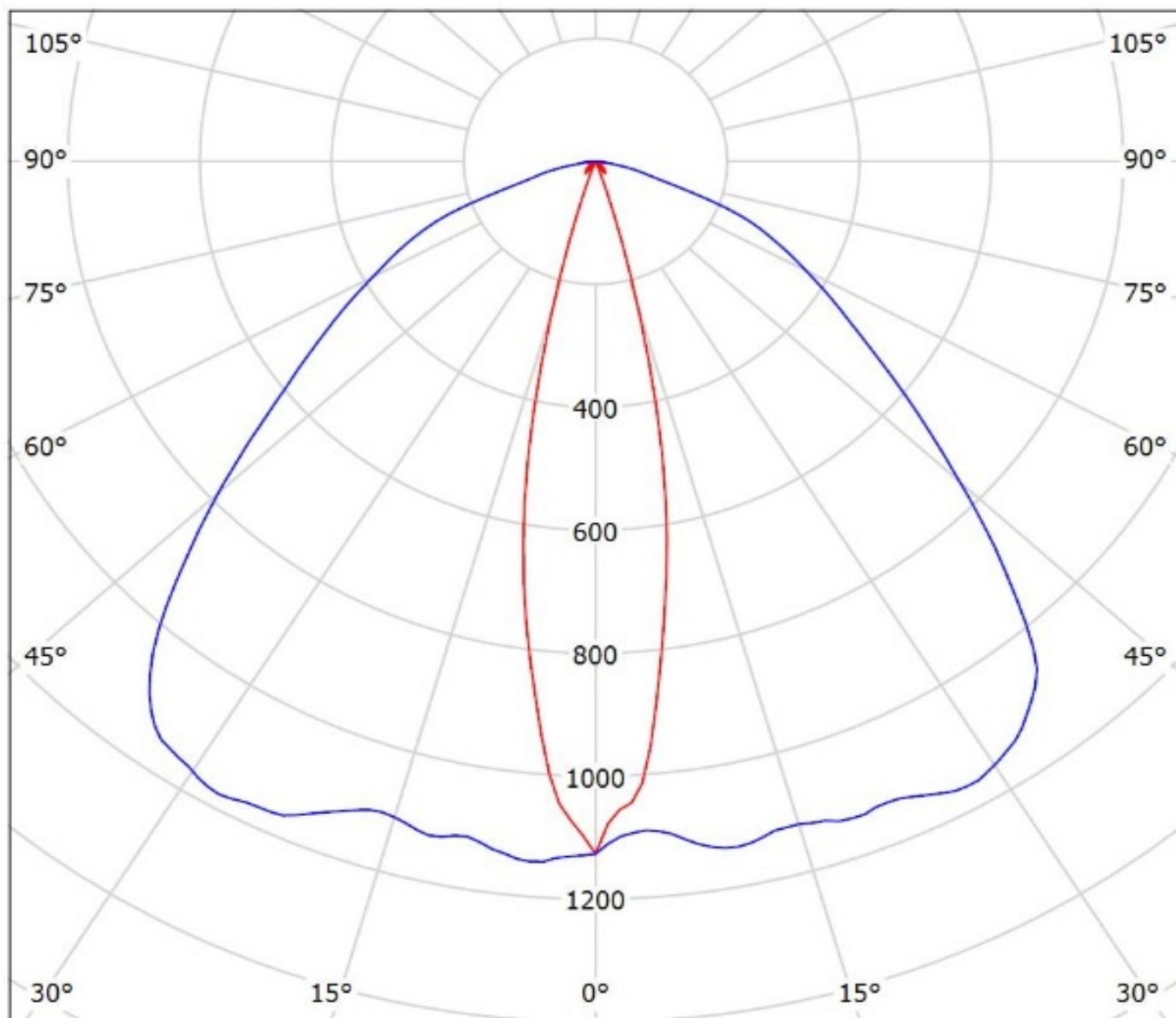

cd/klm

— C0 - C180 — C90 - C270

$\eta = 93\%$

Luminaire: LEDiL Oy C13749_HB-2X2-O_(XP-L)

Lamps: 1 x CREE_XP-L_2x2_(XPLAWT-0-1B0-V40-00-0001)_490lm@250mA_CCT=7600K_P=2.79963W_I=249.9mA

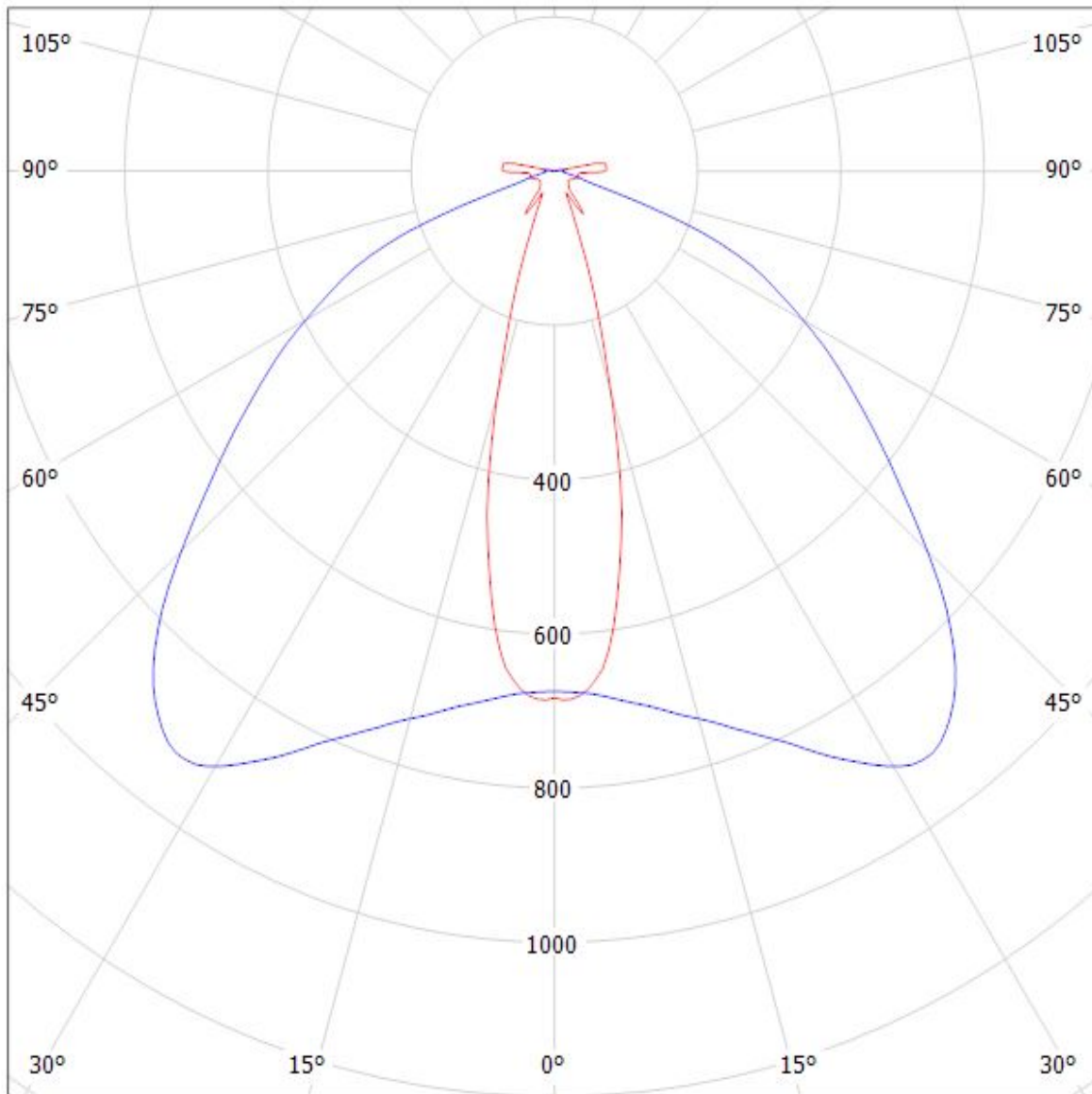

cd/klm

— C0 - C180 — C90 - C270

$\eta = 94\%$

Luminaire: Ledil Oy C13749_HB-2X2-O_(XP-G3)_SIMULATED C13749_HB-2X2-O_(XP-G3)_SIMULATED
Lamps: 1 x Cree XP-G3 - 1.00 W

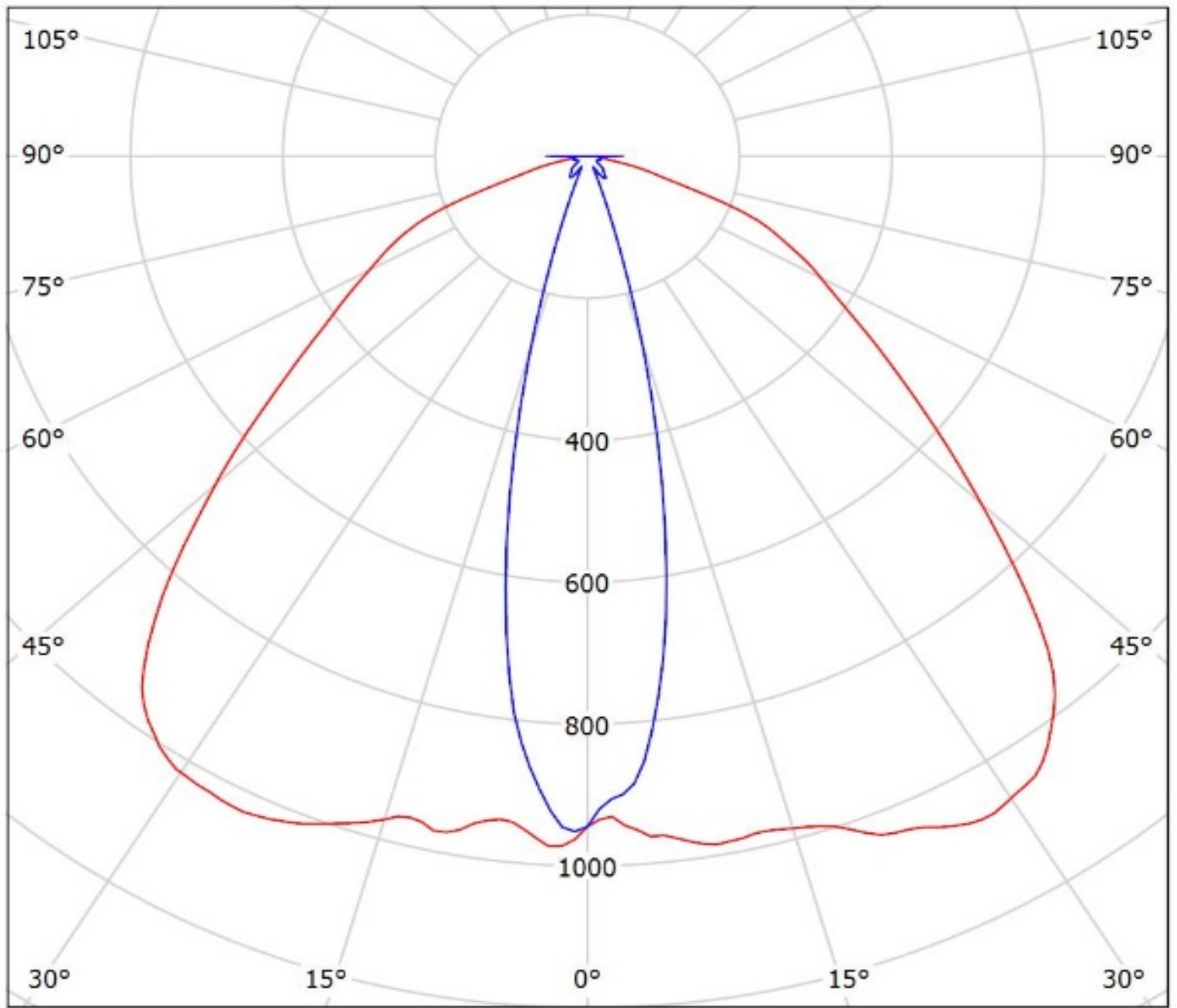

cd/klm
— C0 - C180 — C90 - C270

$\eta = 94\%$

Luminaire: Ledil C13749_HB-2X2-O_(XP-L2)

Lamps: 1 x Cree_XP-L2_2x2_(XPLBWT-00-0000-000BV50E3)550.93lm@250mA_P=2.7815W_I=0.25A

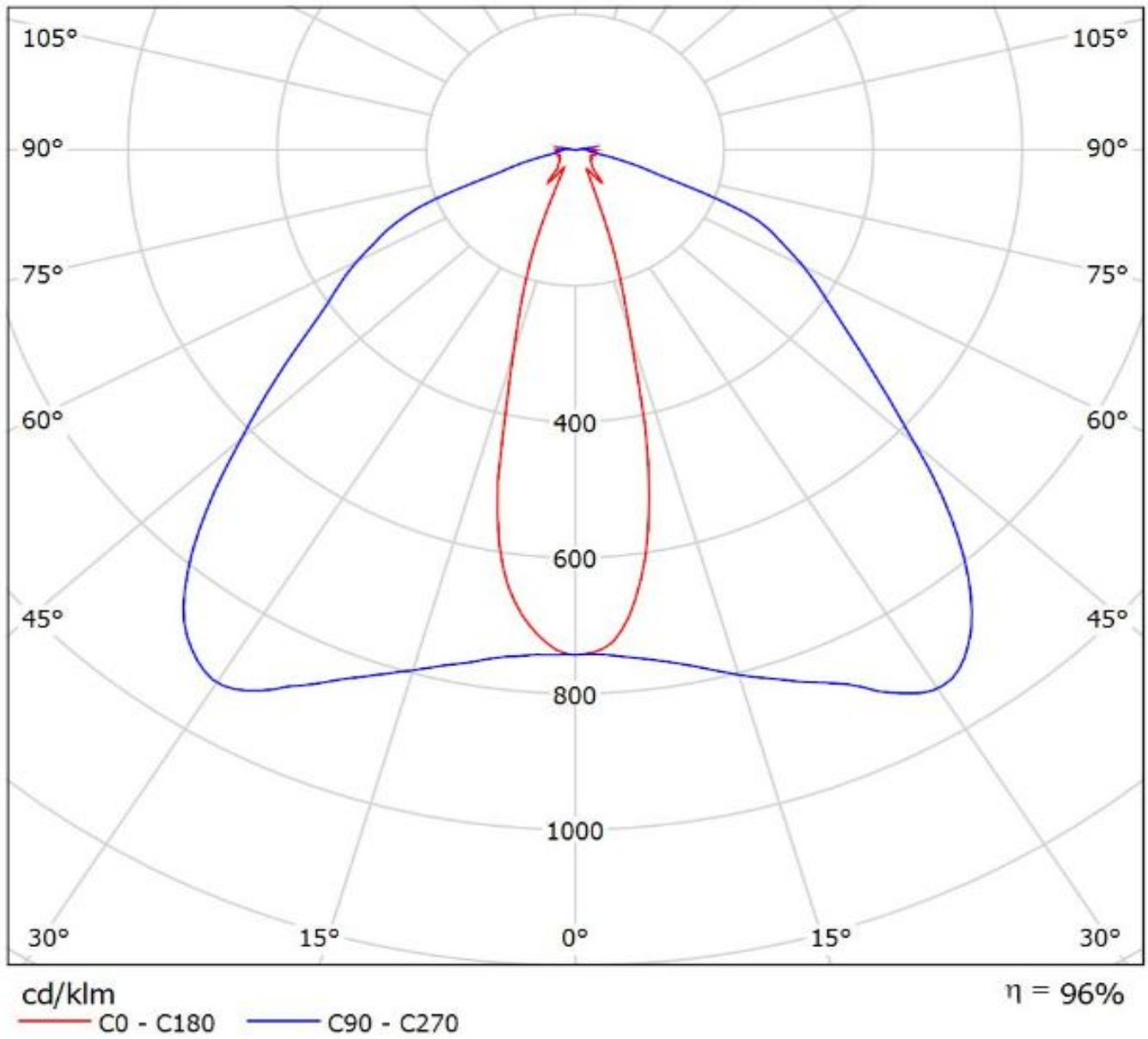

Luminaire: Ledil C13749_HB-2x2-O_(H35C1)

Lamps: 1 x LG_H35C1_2x2_477.216lm@250mA_P=2.87475W_I=0.250A

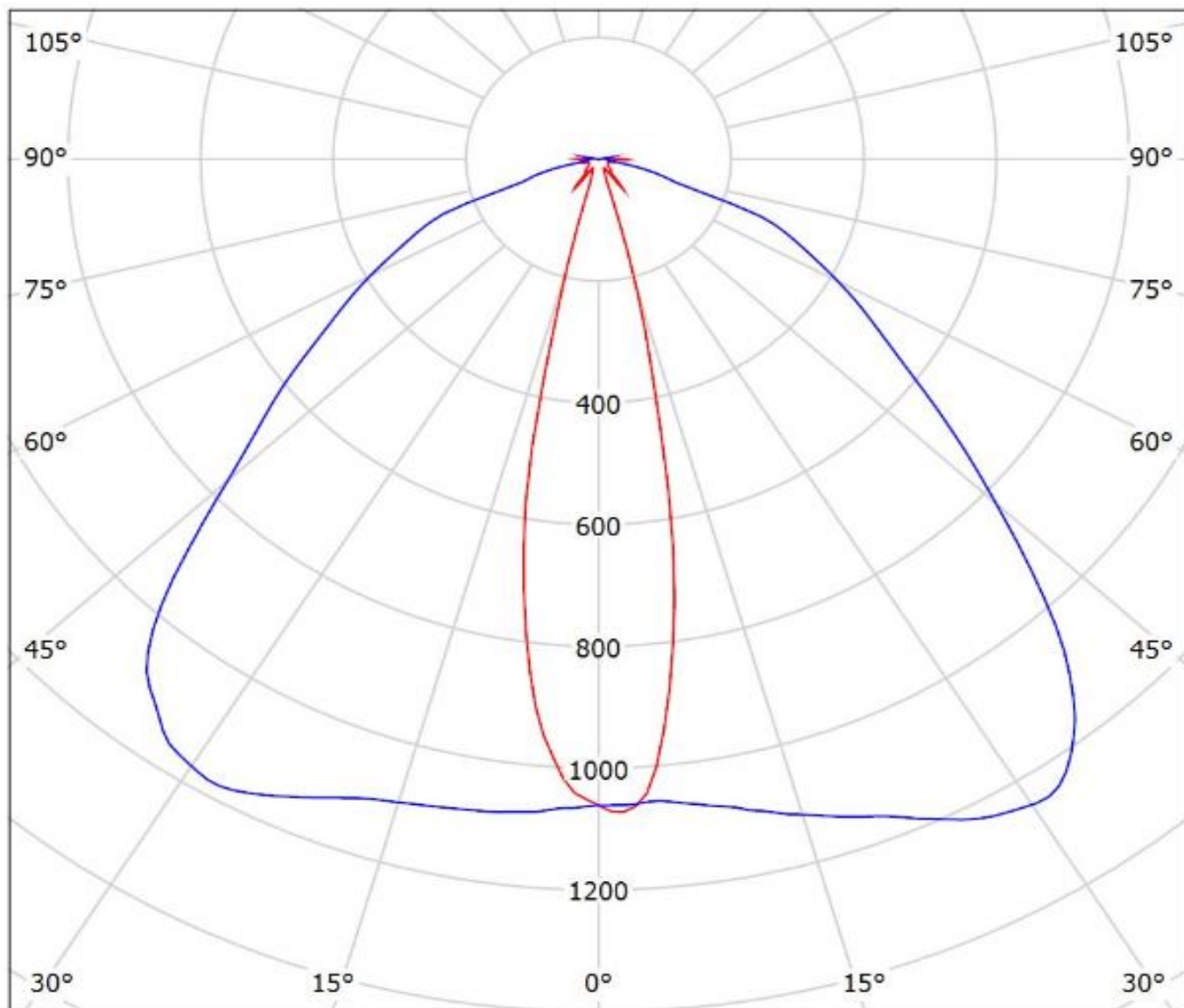

cd/klm

— C0 - C180 — C90 - C270

η = 96%

Luminaire: LEDil Oy C13749_HB-2X2-O_(Luxeon_T) Efficiency=94%
Lamps: 1 x Luxeon T (LXH8-FW30-3) 289lm @ 250mA CCT=3200K P=2.8W I=250mA

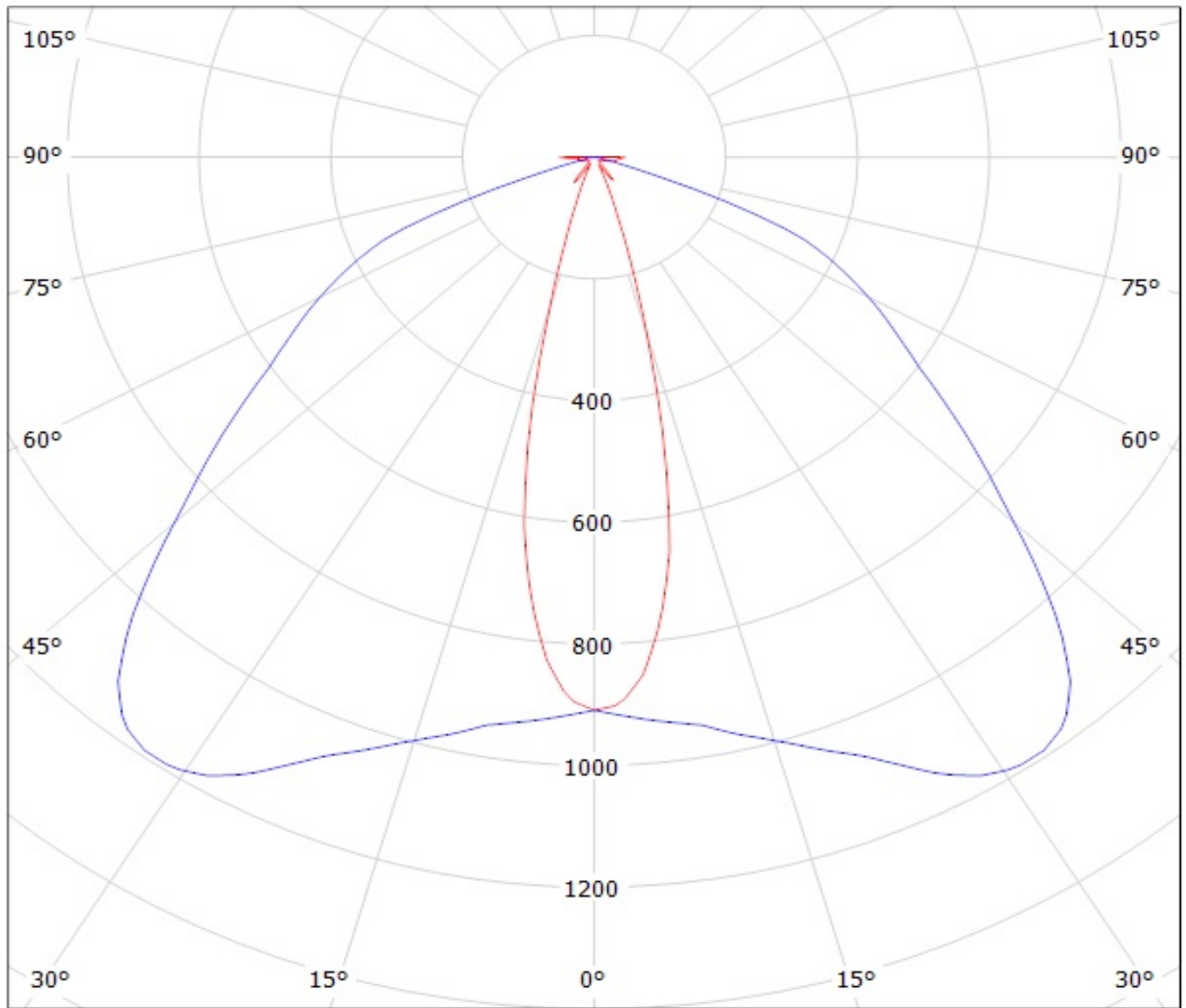

cd/klm

— C0 - C180 — C90 - C270

Luminaire: LEDil Oy C13749_HB-2X2-O_(Luxeon_MZ)

Lamps: 1 x Philips Lumileds Luxeon MZ (413.59lm @ 250mA) P=2.7W I=250mA

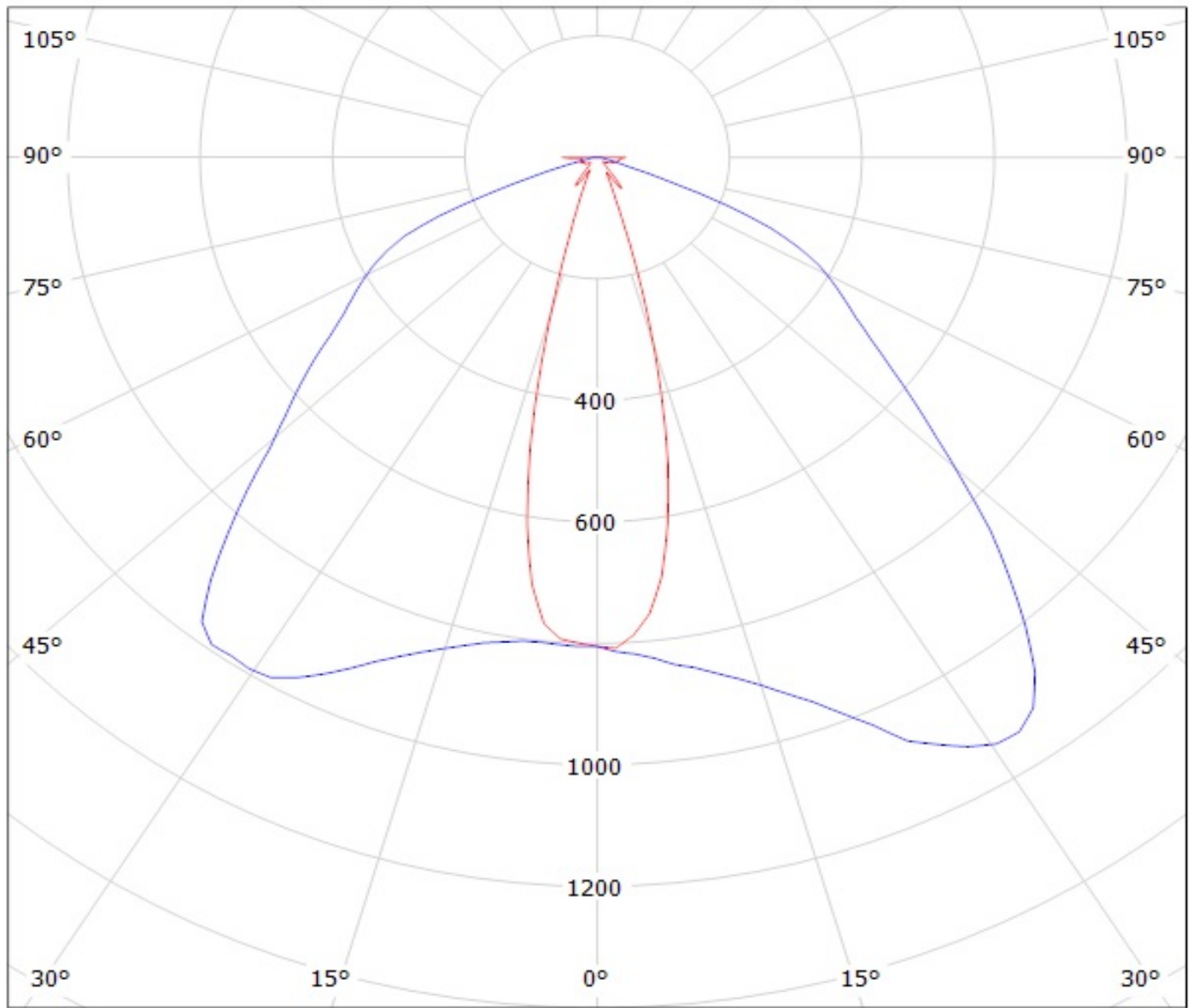

cd/klm

— C0 - C180

— C90 - C270

$\eta = 94\%$

Luminaire: LEDiL Oy C13749_HB-2X2-O_(Luxeon_TX)
Lamps: 1 x Luxeon_TX_2x2_305lm@250mA_P=2.79451W_I=249.8mA

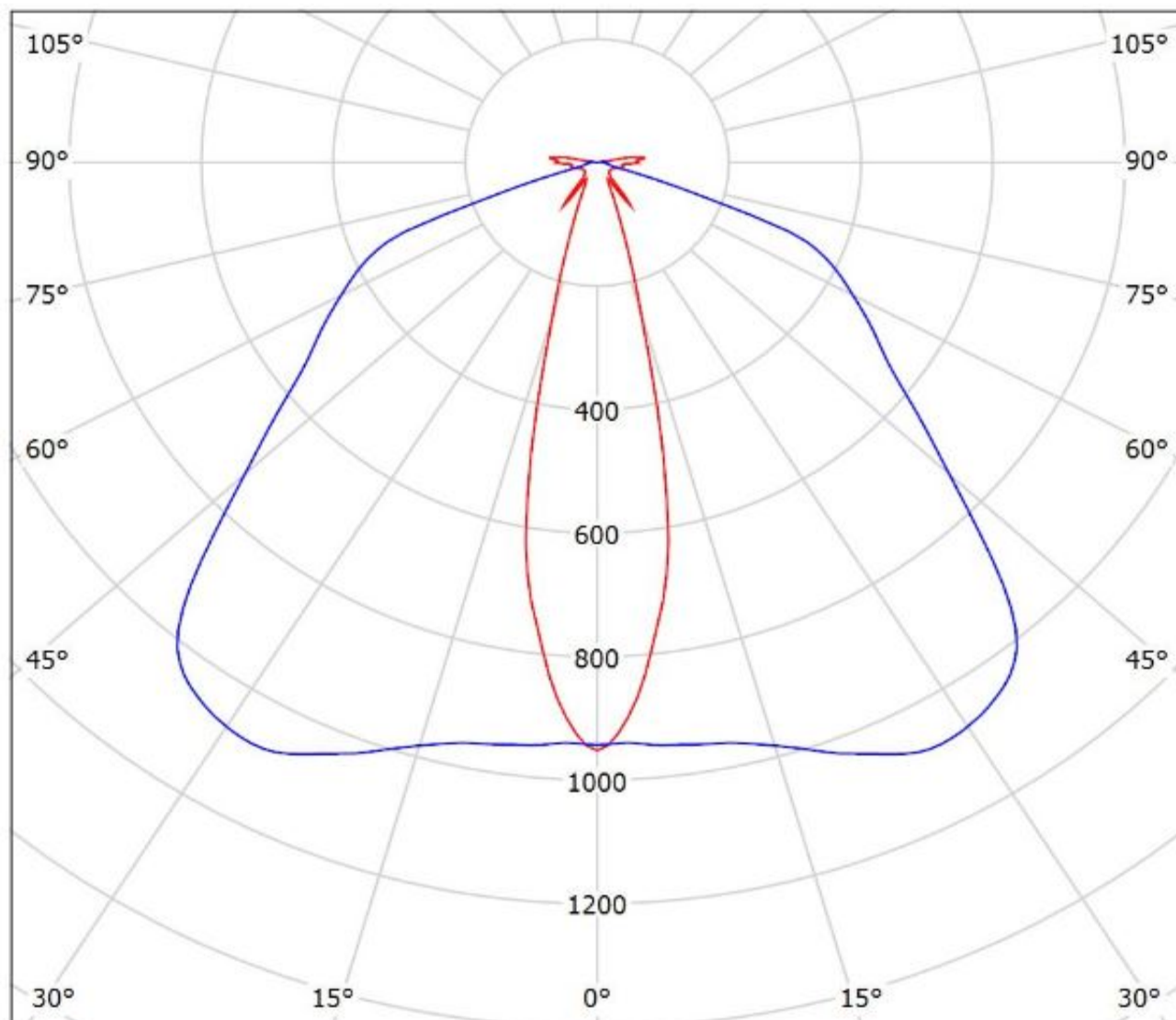

cd/klm
— C0 - C180 — C90 - C270

$\eta = 94\%$

Luminaire: LEDiL Oy C13749_HB-2X2-O_(Luxeon_5050)

Lamps: 1 x Luxeon_5050_2x2_1270.76lm@80mA_CCT=5700K_P=7.35815W_I=0.080A_70CRI

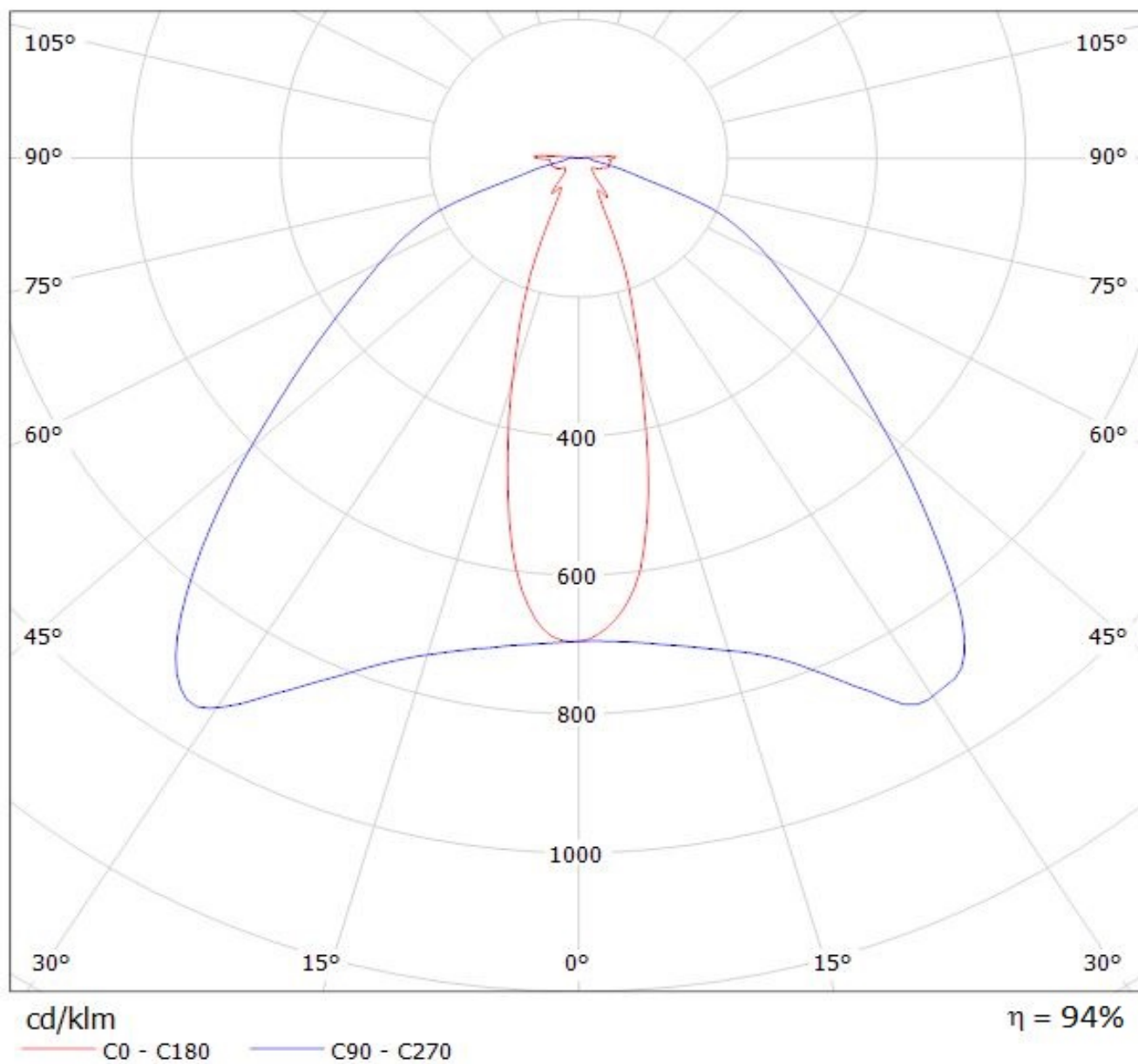

Luminaire: LEDil Oy C13749_HB-2X2-O_(NVSxx19B) Efficiency=94%
Lamps: 1 x Nichia NCSxx19B (NVSL219BE) 315lm @ 250mA CCT=3100K P=2.9W I=250mA

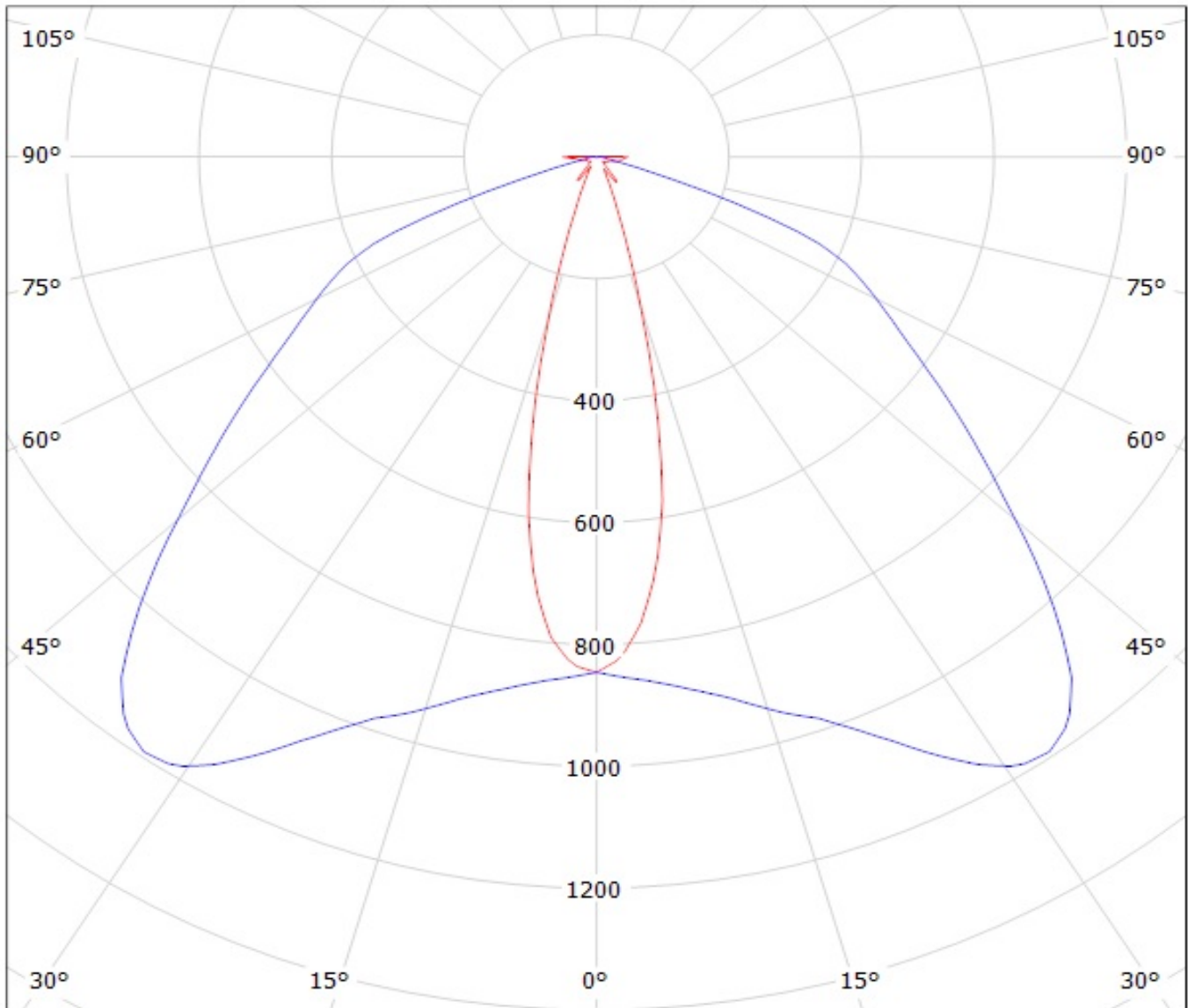

cd/klm
— C0 - C180 — C90 - C270

Luminaire: LEDil Oy C13749_HB-2X2-O_(NCSxx19B) Efficiency=94%
Lamps: 1 x Nichia NCSxx19B (NCSW119BE) 425lm @ 250mA CCT=5400K P=3.1W I=250mA

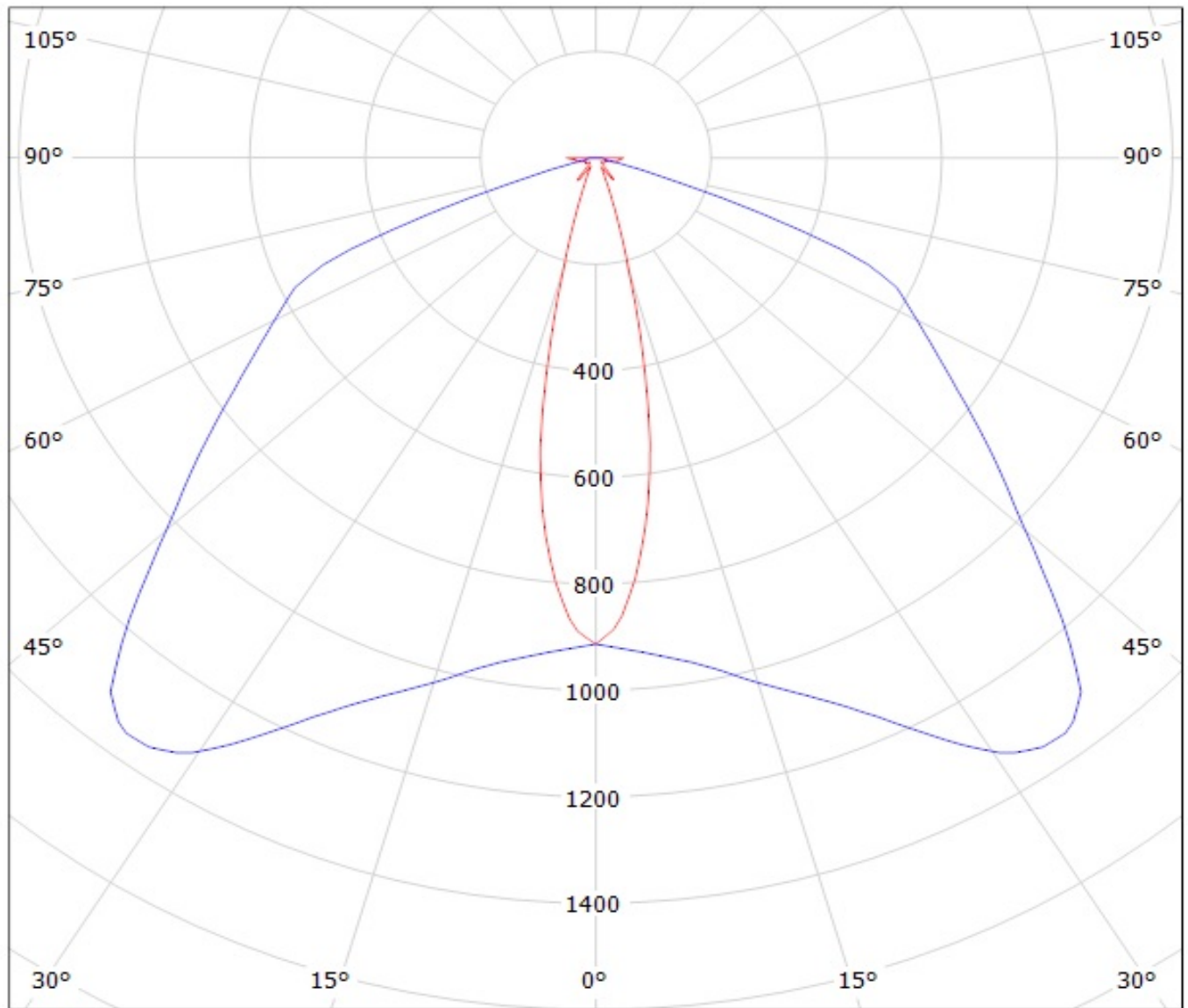

cd/klm

— C0 - C180 — C90 - C270

Luminaire: LEDiL Oy C13749_HB-2X2-O_(NWSL229AE)

Lamps: 1 x Nichia_2X2_NWSL229AE_476.548lm@250mA_P=2.7515W_I=0.250A

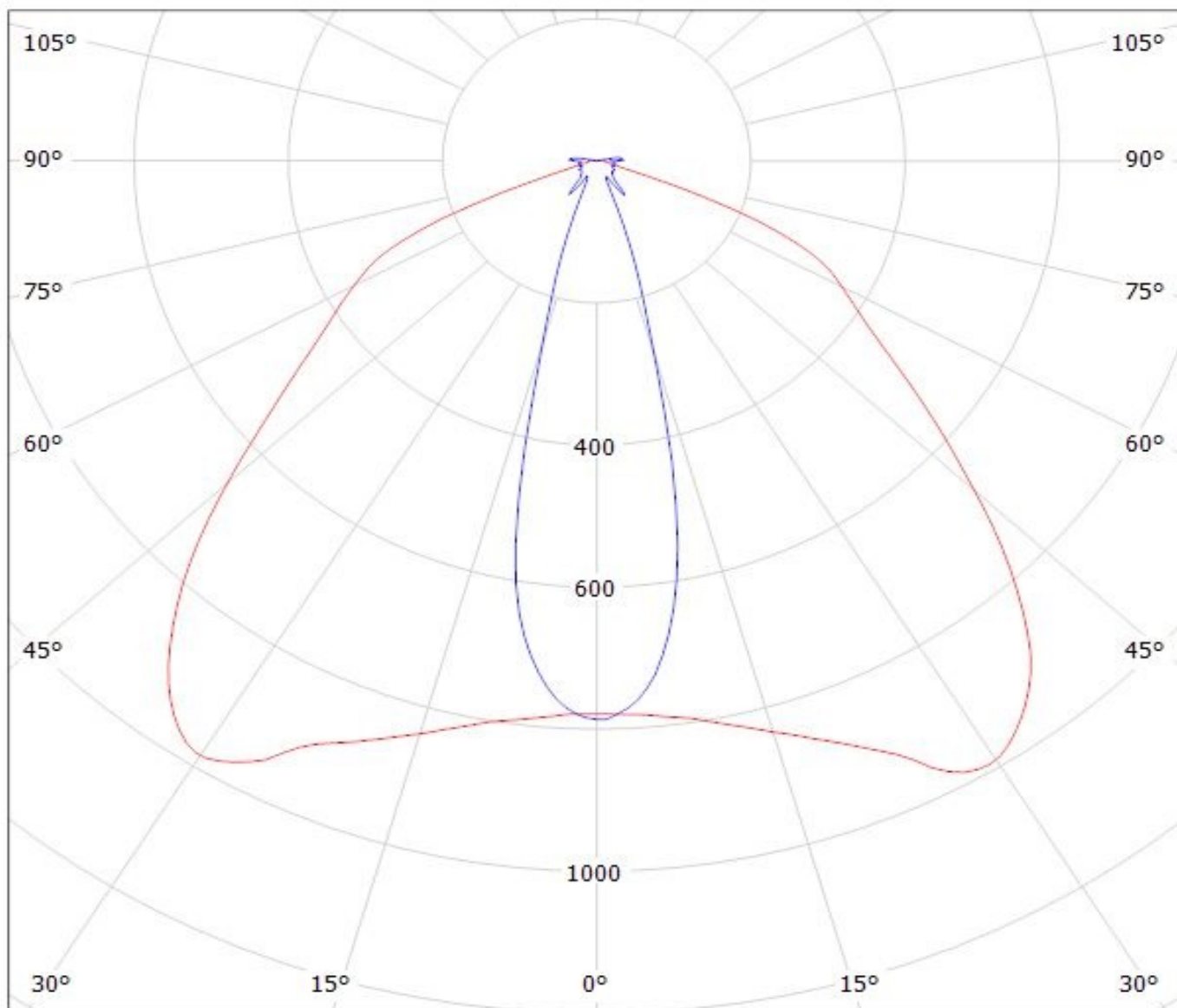

cd/klm

— C0 - C180

— C90 - C270

$\eta = 94\%$

Luminaire: LEDiL Oy C13749_HB-2X2-O_(NVSW3x9A)

Lamps: 1 x Nichia_NVSW3x9A_(sm405/R70)_483.482lmP=2.75904W_I=0.250A

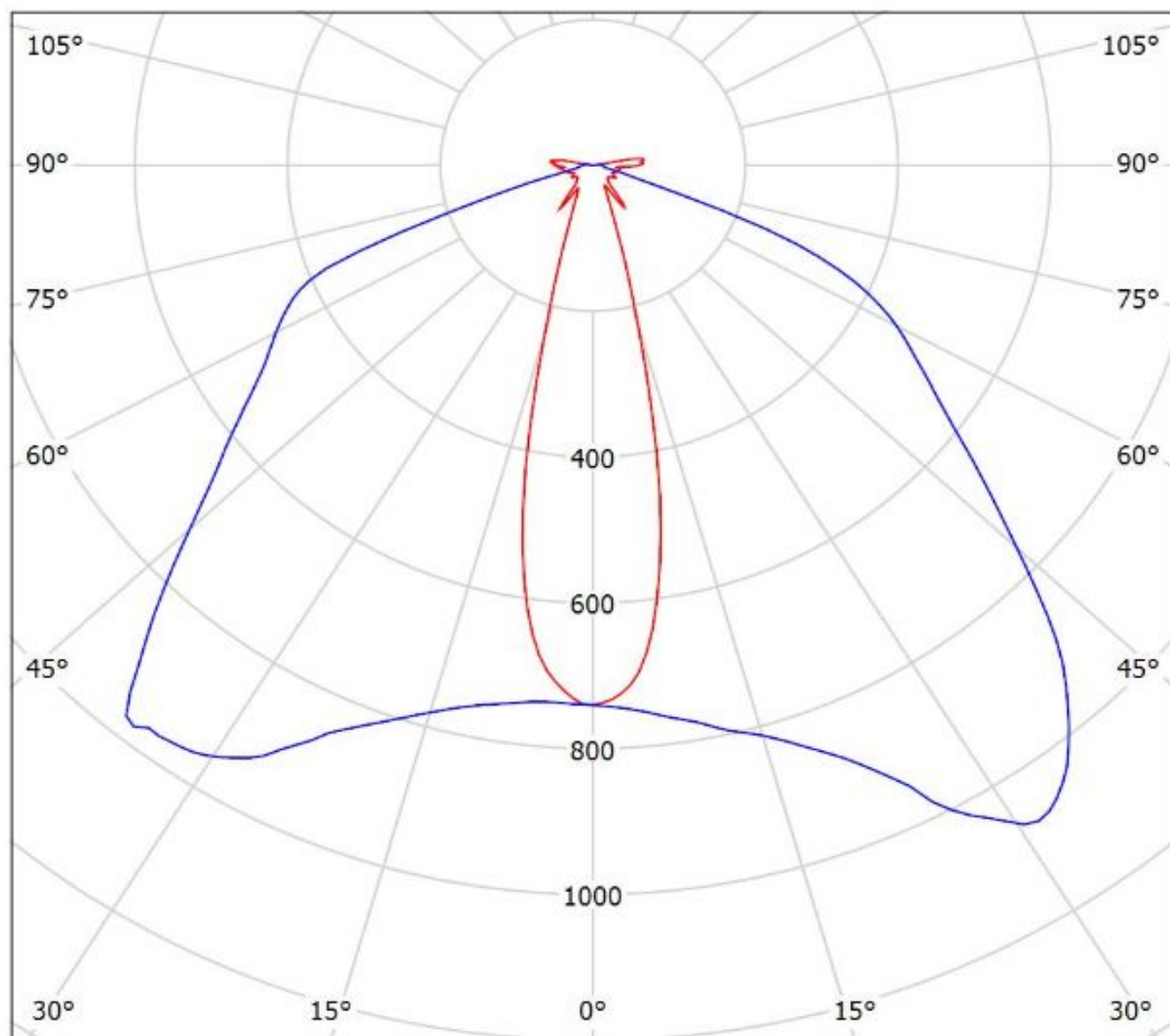

cd/klm
— C0 - C180 — C90 - C270

$\eta = 93\%$

Luminaire: LEDiL Oy C13749_HB-2X2-O_(E21A_2X2)

Lamps: 1 x Nichia_E21A_2X2_451.614lm@250mA_P=2.8045W_I=0.250A

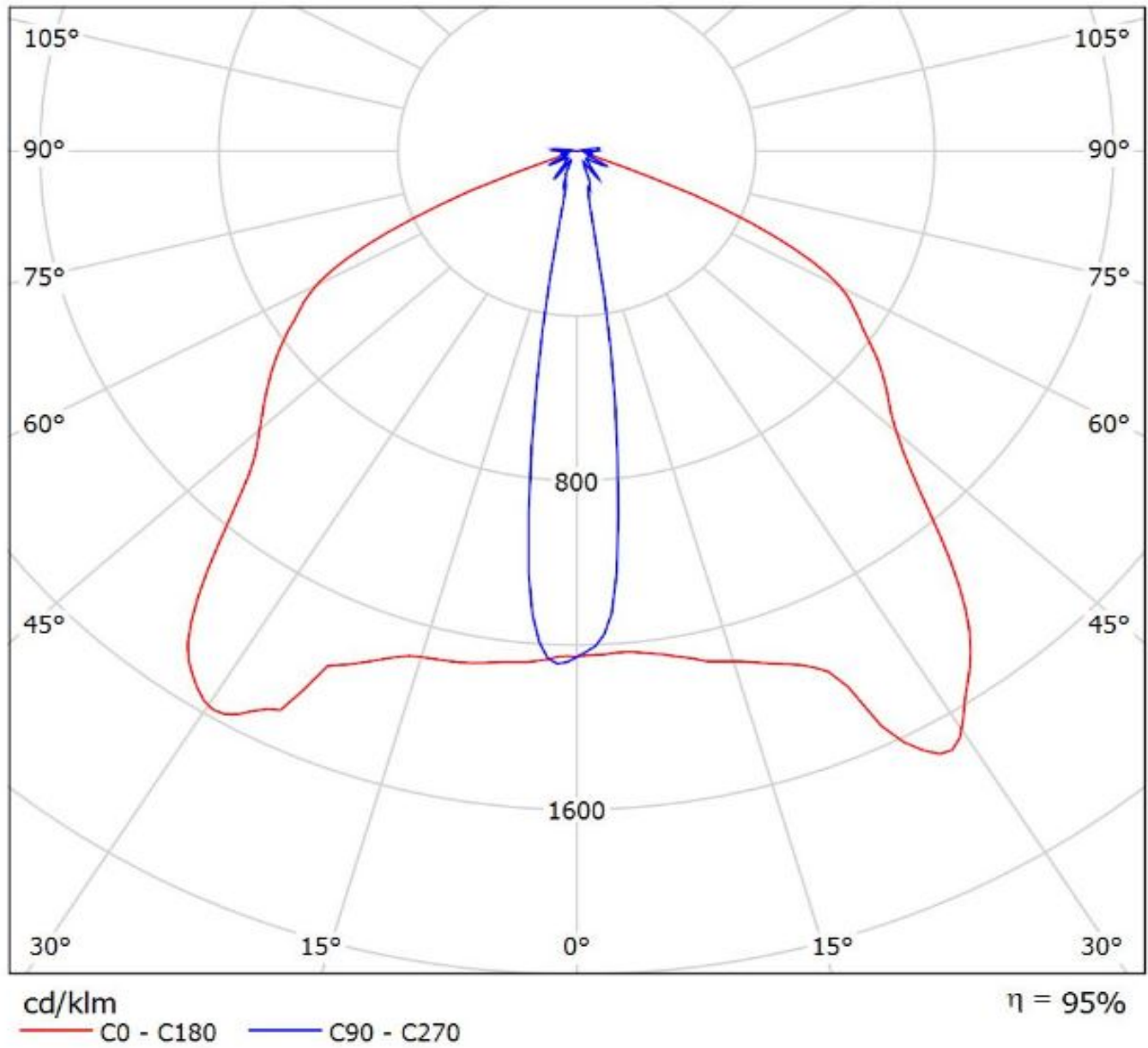

Luminaire: LEDiL Oy C13749 HB-2X2-O_(NVSW319AE)

Lamps: 1 x Nichia_NVSW319AE_499.093lm@250mA_P=2.79052W_I=0.25A

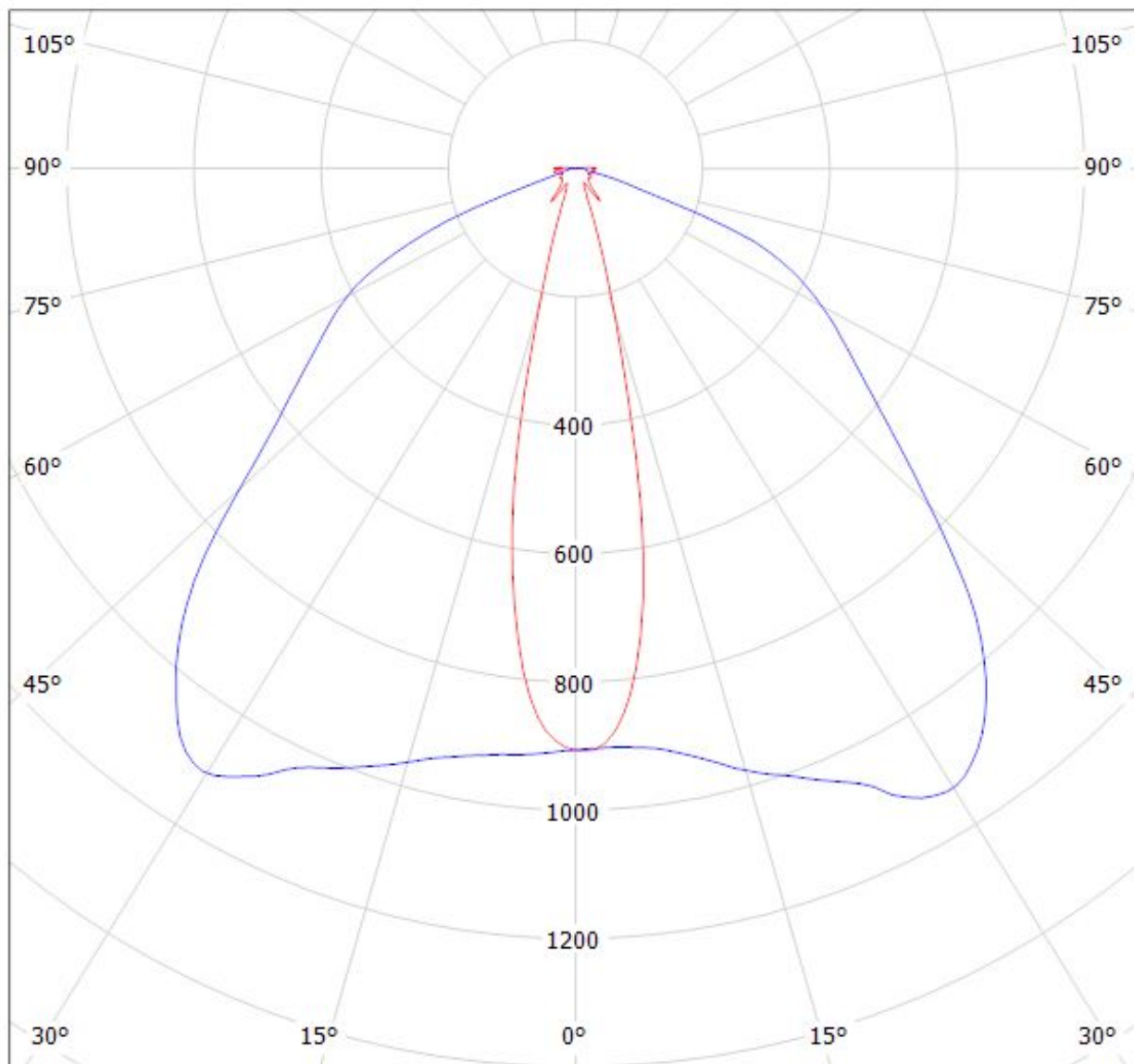

cd/klm

— C0 - C180

— C90 - C270

$\eta = 96\%$

Luminaire: LEDiL Oy C13479_HB-2x2-O_(SQ-PC)

Lamps: 1 x OSRAM_OSLON_SQUARE_PC_2x2_(GWCSSRM1.PC)_414.854lm@250mA_P=2.8626W_CCT=5201K_I=249.9mA

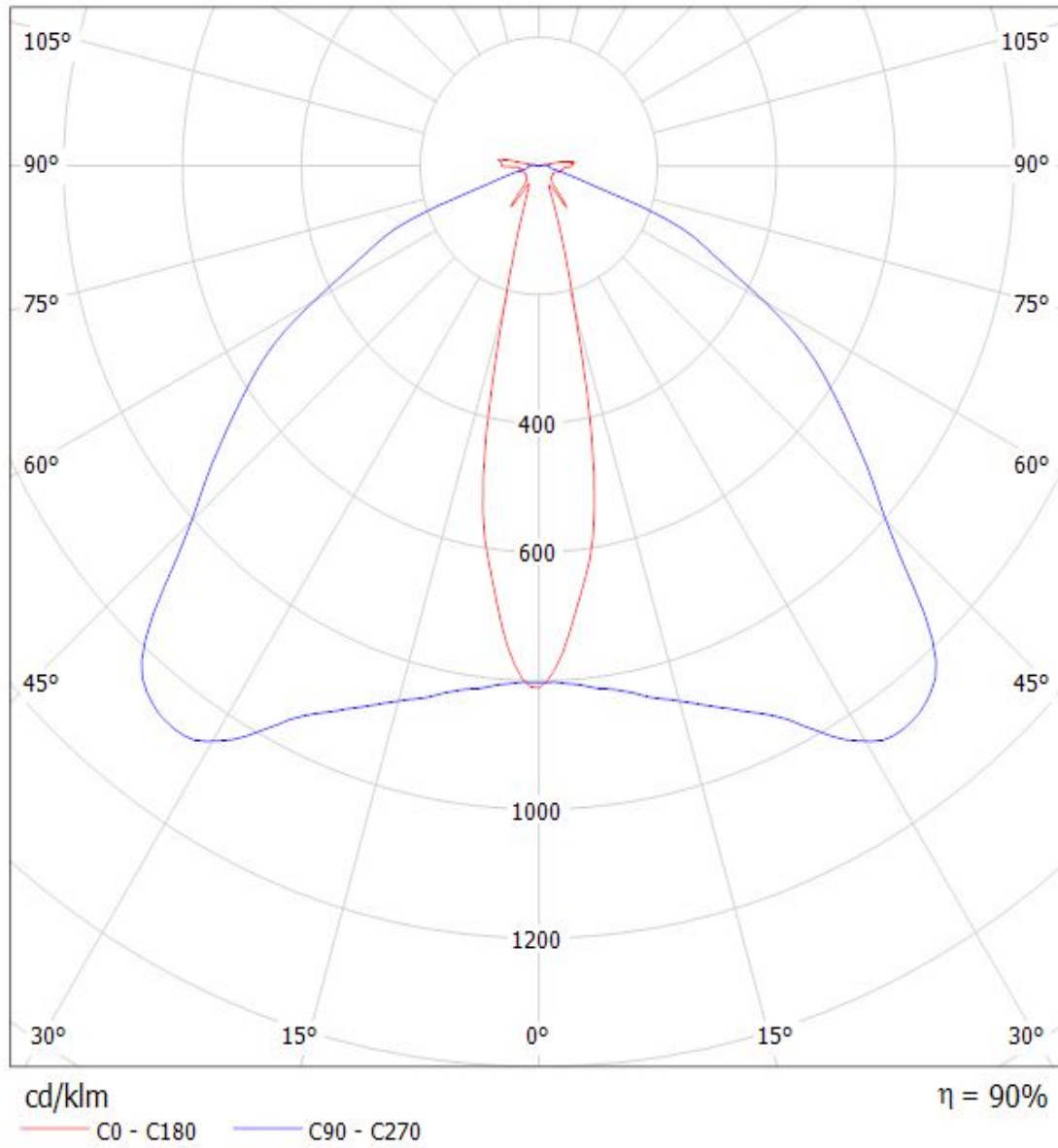

Luminaire: Ledil Oy C13749_HB-2X2-O_(Duris_P8)_SIMULATED
Lamps: 1 x Osram Duris P8

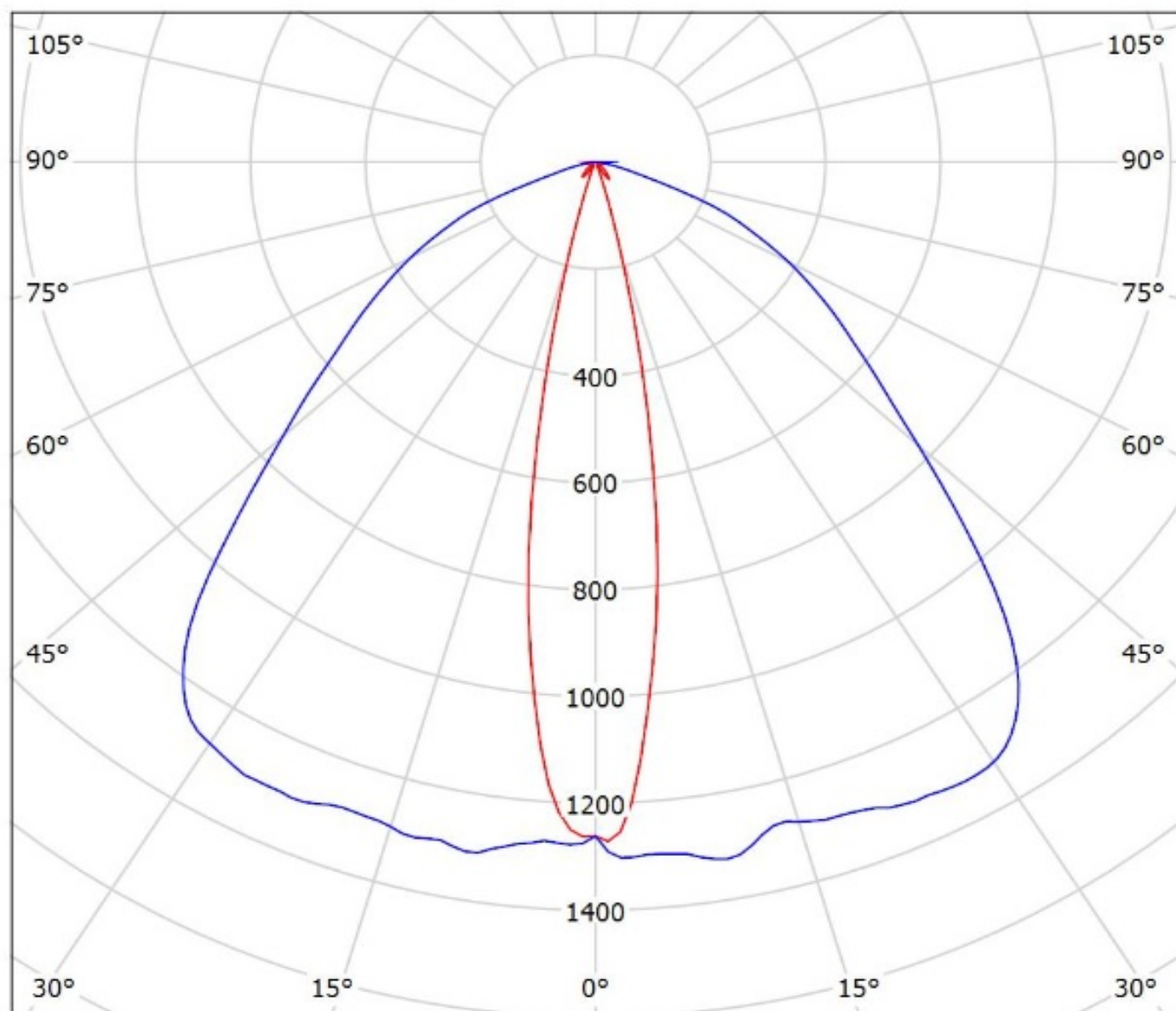

cd/klm

— C0 - C180 — C90 - C270

$\eta = 94\%$

Luminaire: Ledil C13749_HB-2X2-O_(Fortimo_FastFlex_LED_board_2x8/740_DA_G3)

Lamps: 1 x Fortimo_FastFlex_LED_board_2x8/740_DA_G3_1828.23lm@250mA_P=11.667W_I=0.25A

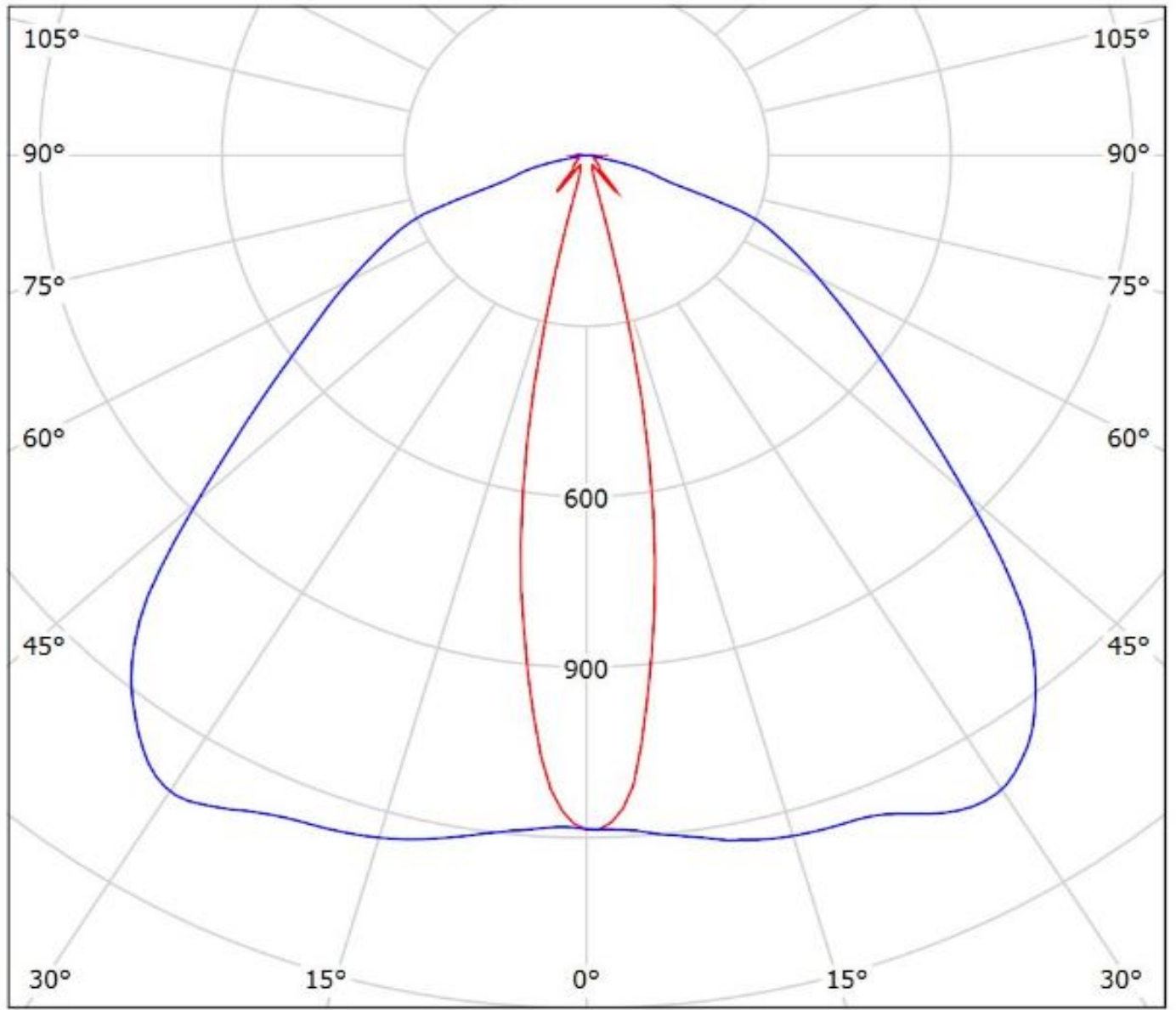

cd/klm
— C0 - C180 — C90 - C270

$\eta = 96\%$

Luminaire: LEDiL Oy C13749_HB-2X2-O_(LH351Z)

Lamps: 1 x SAMSUNG_LH351Z_2x2_361.9lm@250mA_P=2.86371W_I=249.8mA

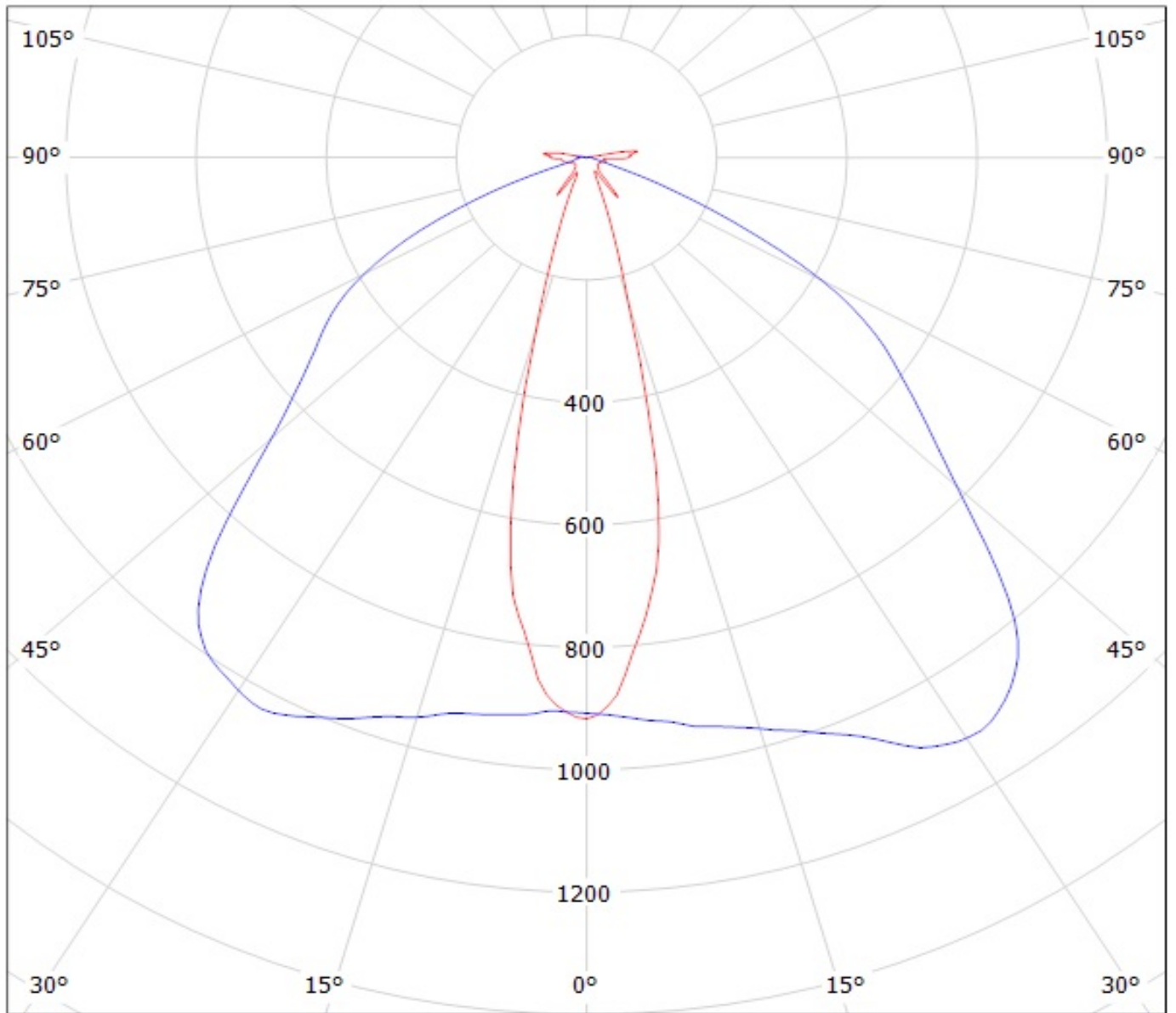

cd/klm

— C0 - C180 — C90 - C270

$\eta = 94\%$

Luminaire: Ledil C13749_HB-2X2-O_(LH351B)

Lamps: 1 x Samsung_LH351B_2x2_444.178lm@250mA_P=2.8535W_I=0.25A

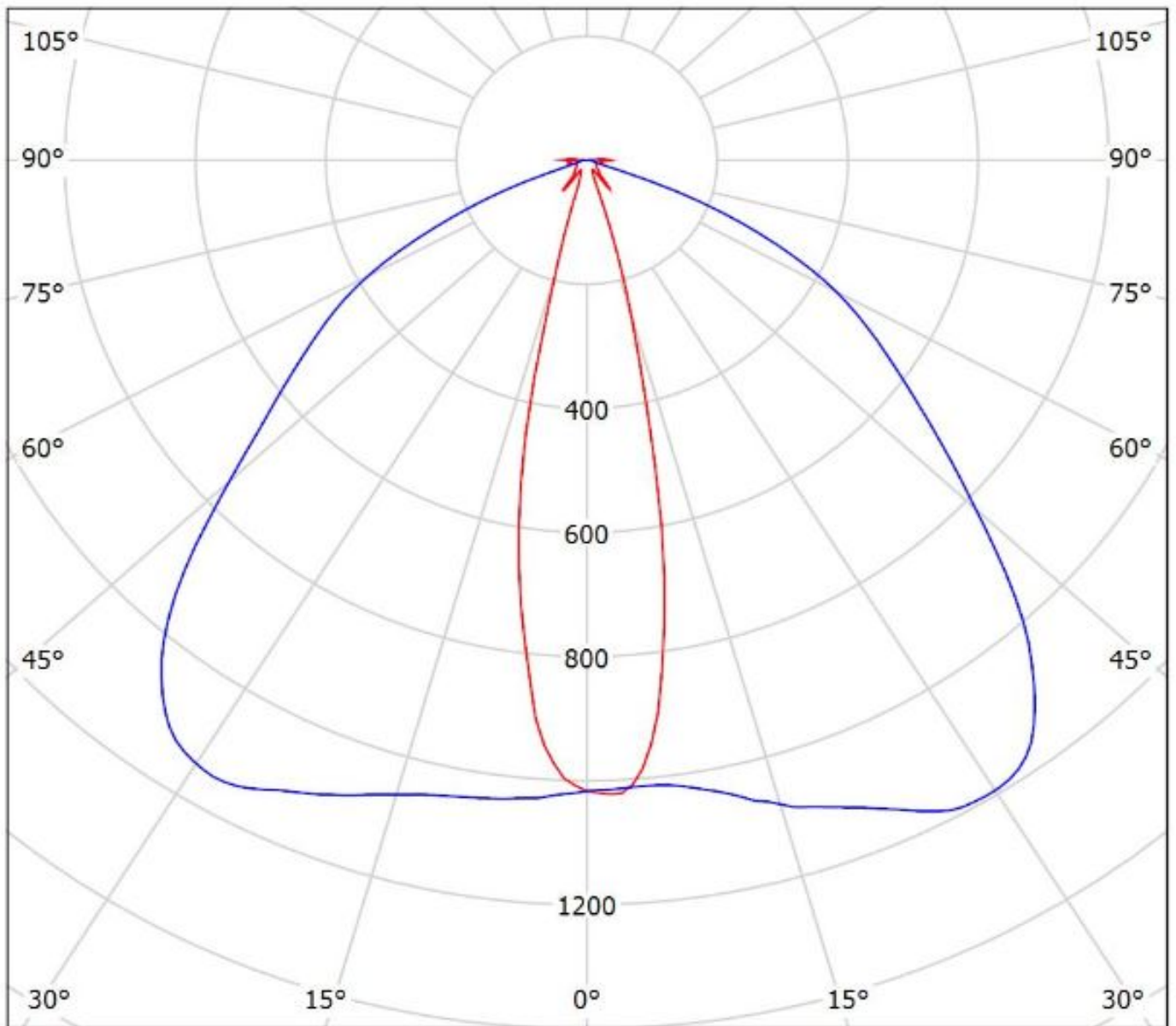

cd/klm

— C0 - C180 — C90 - C270

$\eta = 96\%$

Luminaire: Ledil C13749_HB-2X2-O_(LH351D)

Lamps: 1 x Samsung_LH351D_536.957lm@250mA_P=2.7695W_I=0.250A

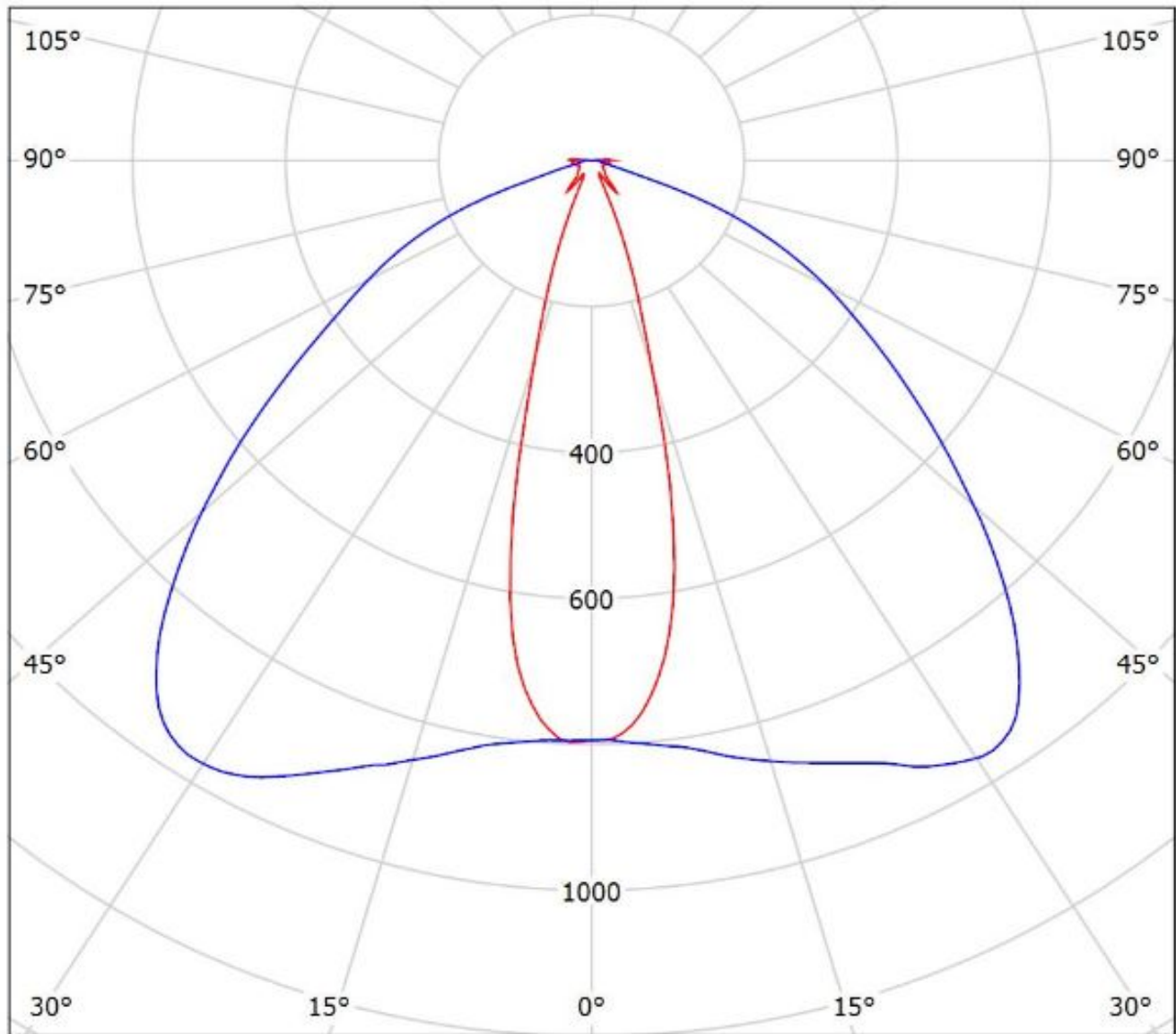

cd/klm

— C0 - C180

— C90 - C270

$\eta = 96\%$

Luminaire: Ledil Oy C13749_HB-2X2-O_(Z5M2)_SIMULATED
Lamps: 1 x Seoul Z5M2 (SZ5-M2-W0-00)

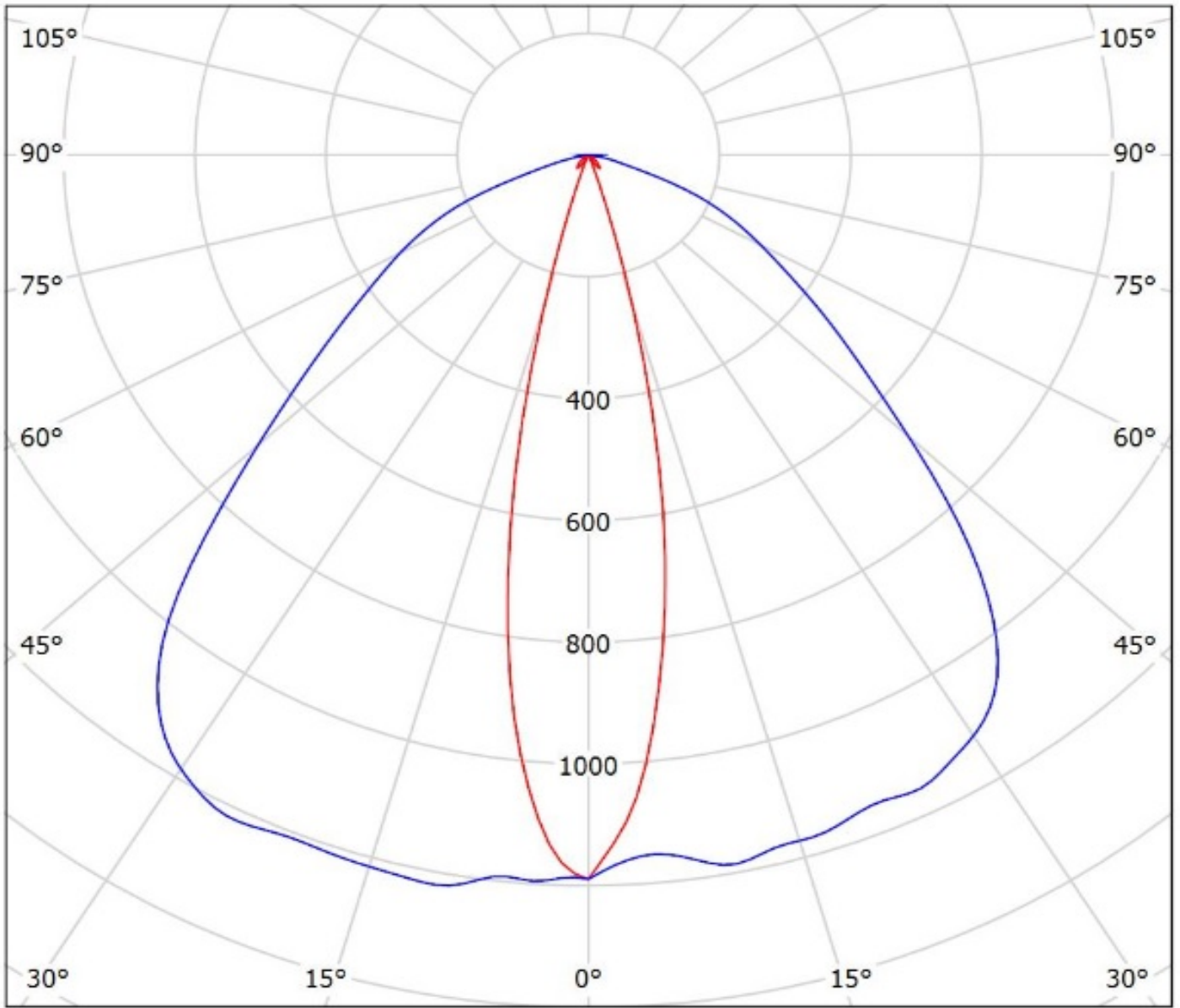

cd/klm

— C0 - C180 — C90 - C270

$\eta = 94\%$

Luminaire: LEDiL Oy C13749_HB-2X2-O_(Tridonic_Module_RLE_G1)
Lamps: 1 x Tridonic_Module_RLE_G1_4576.03lm@700mA_P=32.0681W_I=0.700A

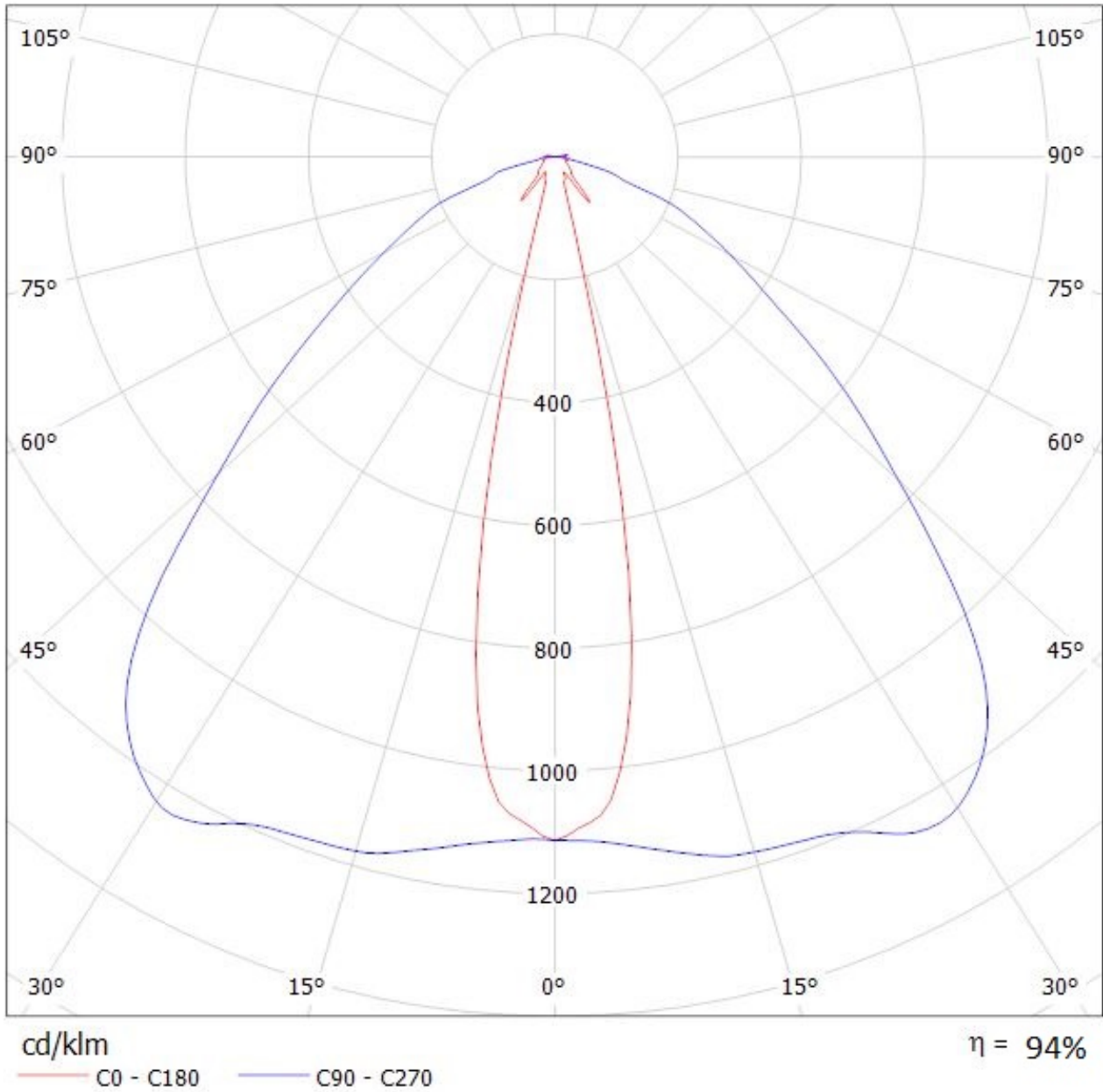

Luminaire: LEDiL Oy C13749_HB-2X2-O_(Tridonic_Module_RLE_G1)
Lamps: 1 x Tridonic_Module_RLE_G1_4576.03lm@700mA_P=32.0681W_I=0.700A

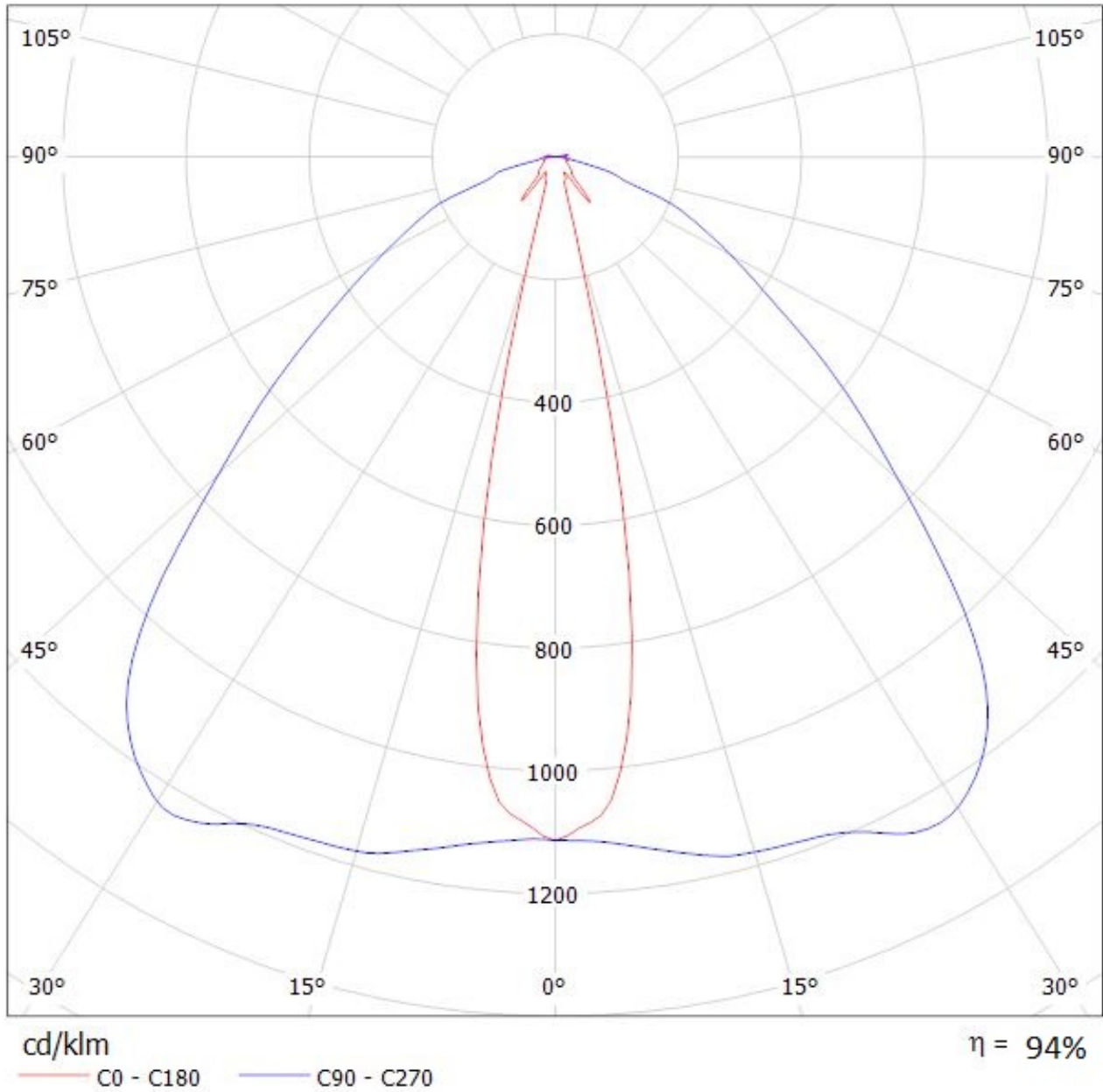

Luminaire: LEDiL Oy C13749_HB-2X2-O_(Tridonic_Module_RLE_G1)
Lamps: 1 x Tridonic_Module_RLE_G1_2288lm@700mA_P=16W_I=0.700A

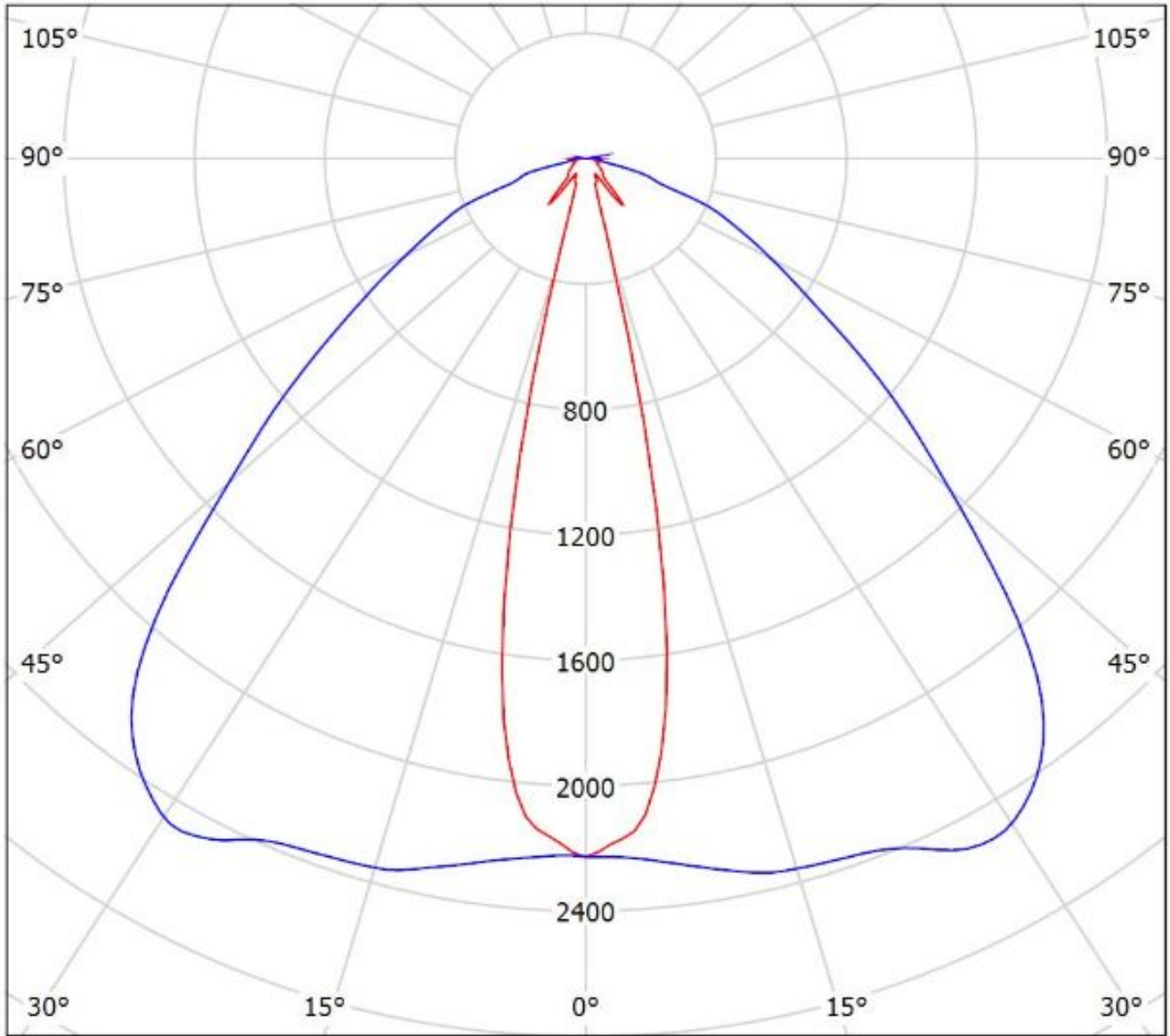

cd/klm
— C0 - C180 — C90 - C270

$\eta = 193\%$

Luminaire: LEDiL Oy C13749_HB-2X2-O_(Tridonic_Module_RLE_G1)
Lamps: 1 x Tridonic_Module_RLE_G1_2288lm@700mA_P=16W_I=0.700A

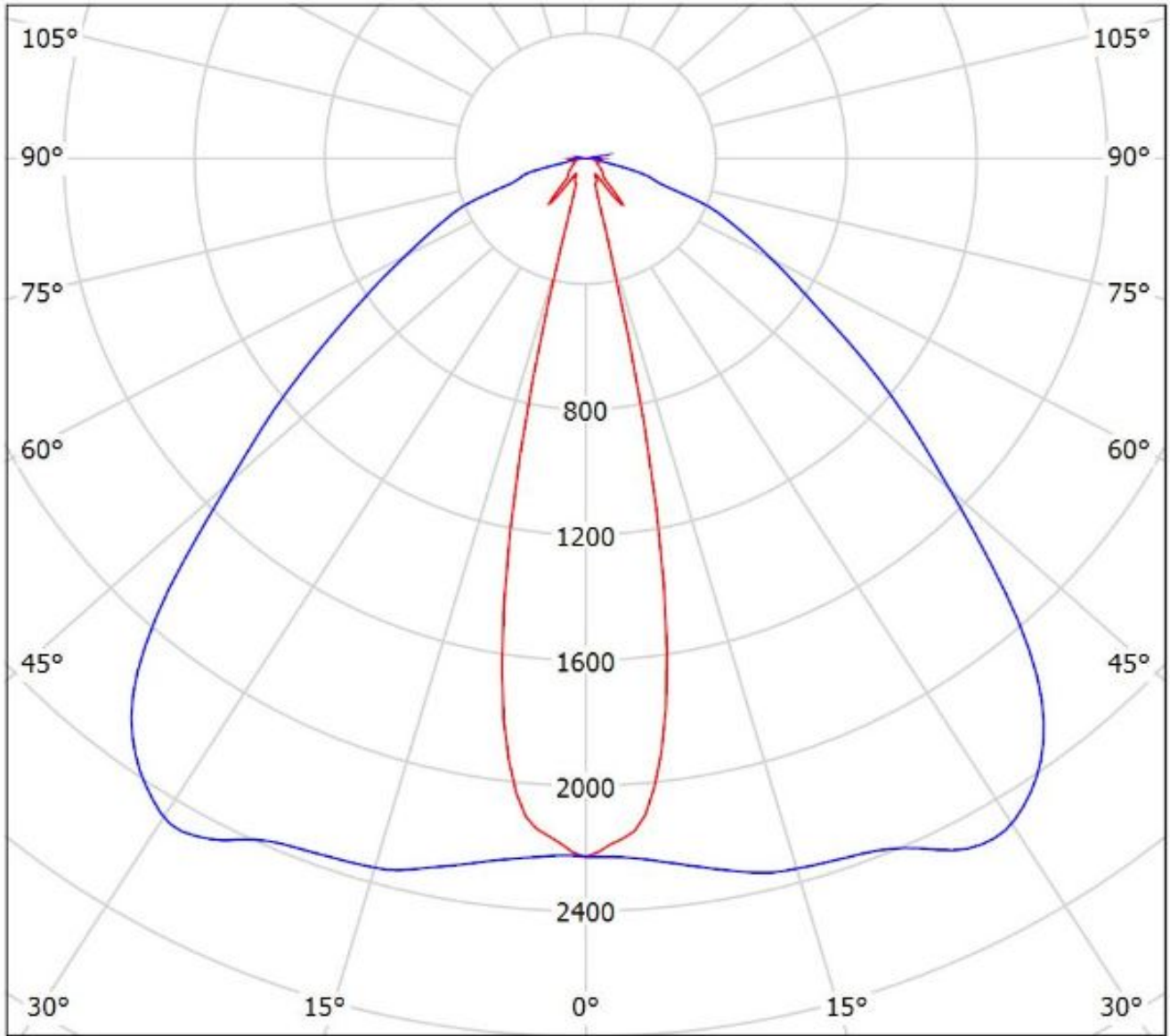

cd/klm

— C0 - C180 — C90 - C270

$\eta = 193\%$

NOTE: The typical divergence will be changed by different color, chip size and chip position tolerance. The typical total divergence is the full angle measured where the luminous intensity is half of the peak value.