

Data sheet

Commercial Art.No.: 25.841.0553.0

PCB connector 8213 BFK / 5 TOP F

PCB female connector with tension spring connection, 5 poles, printed version, max. cross section: 2.5 mm², pitch: 5.08 mm, type of packing: carton, color: grey



Commercial Art.No.	25.841.0553.0
EAN	4015573614956
Order Unit	50

Certificates / Approvals



Technical data

General

Modular spacing	5.08 mm
Connection type	spring clamp connection
Soldering process	None
Packaging	Carton
Number of poles	5
Marking	yes
Fastening	Flange
Mating direction towards connector	180°

Technical data

Nominal cross section	2.5 mm ²
Rated current	12 A
Overvoltage Category I	1000 V
Overvoltage Category II	400 V
Overvoltage Category III	250 V
Rated impulse voltage	4 kV
Wire strip length	11 mm

Connection Data

Minimum cross section solid	0.14 mm ²
Maximum cross section solid	2.5 mm ²
Minimum cross section fine stranded	0.14 mm ²
Maximum cross section fine stranded	2.5 mm ²
Wire strip length	11 mm

Technical Data UL/CSA

Cross section UL	22-12 AWG
------------------	-----------

Voltage UL	300 V
Current field wiring	12 A
Current factory wiring	12 A
Cross section CSA	22-16 AWG
Voltage CSA	300 V
Current CSA	12 A

Other

Type of insulation material	Thermoplastic
Color	Grey
Height	15 mm
Length	25.4 mm
Depth	24.3 mm
Material attachment screw	None
Material contact base	Steel
Material contact surface	Sn

Classification

ECLASS 11	
ECLASS 8.1	27440402
ETIM 7.0	EC002637
ETIM 6.0	EC002637
ETIM 5.0	EC002637
ETIM 4.0	EC002637

Fits with

Commercial Art.No.:	Article-type description:	Description:
25.358.3553.0	PCB pin header 8213 S / 5 WF OB	PCB pin header, connection method depends on used socket part , 5 poles, pitch: 5.08 mm, type of packing: carton, color: grey
25.359.3553.0	PCB pin header 8213 S / 5 GF OB	PCB pin header, connection method depends on used socket part , 5 poles, pitch: 5.08 mm, type of packing: carton, color: grey
25.359.3506.0	PCB pin header 8213 S / 5 GF THR	PCB pin header, connection method depends on used socket part , 5 poles, with solder pin (2.6mm, tin plated), pitch: 5.08 mm, type of packing: carton, color: grey, This product can be soldered by reflow and wave soldering,

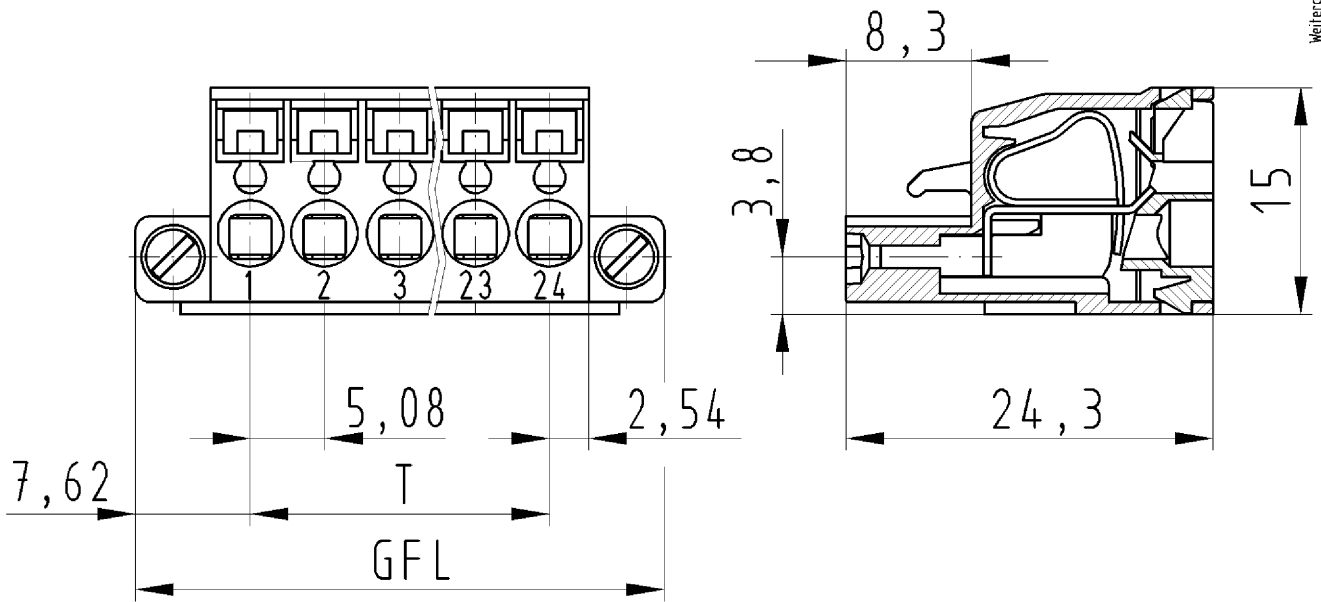

für folgende Tabellen-Zchnng.:
25.841.0253.0 8213 BFK/.. TOP K F

LP . STECKKLEMME
25.841.0253.0 10W
06.11.2007 DÜT
M 2:1