



给您一颗快乐的“芯”！

YSX321SL



Features

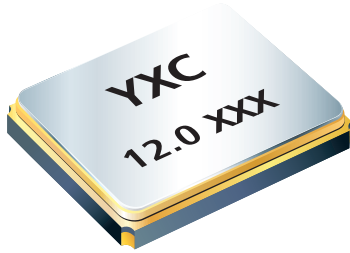

- External dimensions: 3.2 x 2.5 x 0.7 mm.
- Frequency range: 8MHz ~ 64MHz.
- High precision and high frequency stability.
- Extremely good for reducing EMI effect.
- RoHS Compliant / Pb Free.
- The best choice of Bluetooth, wireless communication set, DSC, PDA and mobile phone.

Electrical Specifications

Item / Type	YSX321SL
Nominal Frequency Range	8 ~ 64 MHz
Vibration Mode	AT Fundamental
Load Capacitance	12pF, 20pF, or specify
Frequency Tolerance (at 25 °C)	± 10 ppm, ± 20 ppm, or specify
Frequency Versus Temperature Characteristics	±20 ppm, or specify
Operating Temperature	- 20 ~ + 70 °C , - 40 ~ + 85 °C , or specify
Storage Temperature	- 40 ~ + 85 °C , or specify
Shunt Capacitance	7 pF Max.
Level Of Drive	1~100 μ W Max. (10 uW typical)
Frequency Aging (at 25 °C)	± 3 ppm / year Max.
Insulation Resistance	More Than 500MΩ at DC 100V

Equivalent Series Resistance(ESR)

Fundamental	
8 ~ 11.2892 MHz	150 Ω Max.
12 ~ 16 MHz	80 Ω Max.
17 ~ 64 MHz	50 Ω Max.

Dimensions

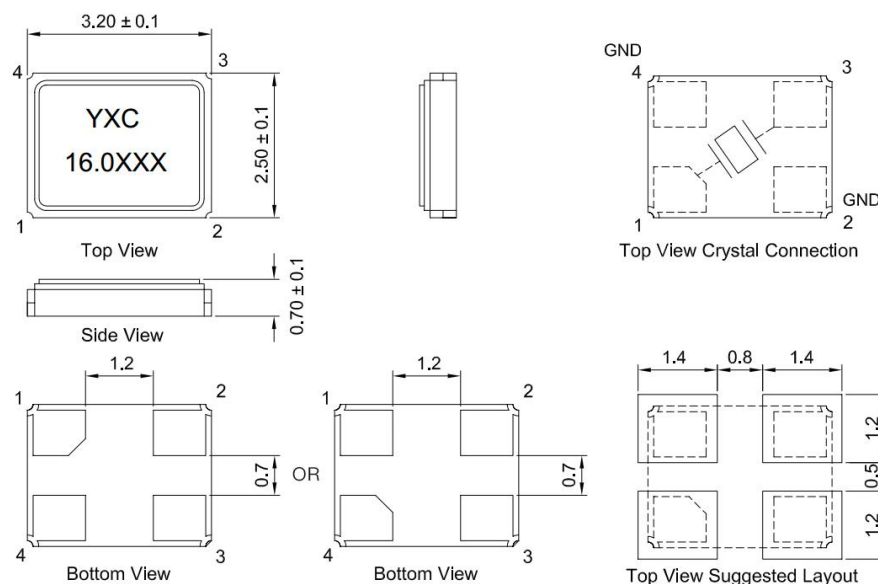

Units: mm



给您一颗快乐的“芯”！

YSX321SL



★ PART NUMBER GUIDE 部件号示例 e.g. X322512MSB4SC YSX321SL = 3.2×2..5 SMD SEAM TYPE

Quartz Crystal Resonator	Dimensions	Frequency (Hz)	Load Capacitance (Pf)	Frequency Stability Overall (ppm)	Pin	Material	Operating Temp. Range
X	3225	12M	S	B	4	S	C

★ TAPING SPECIFICATION (Unit: mm) 编带规格

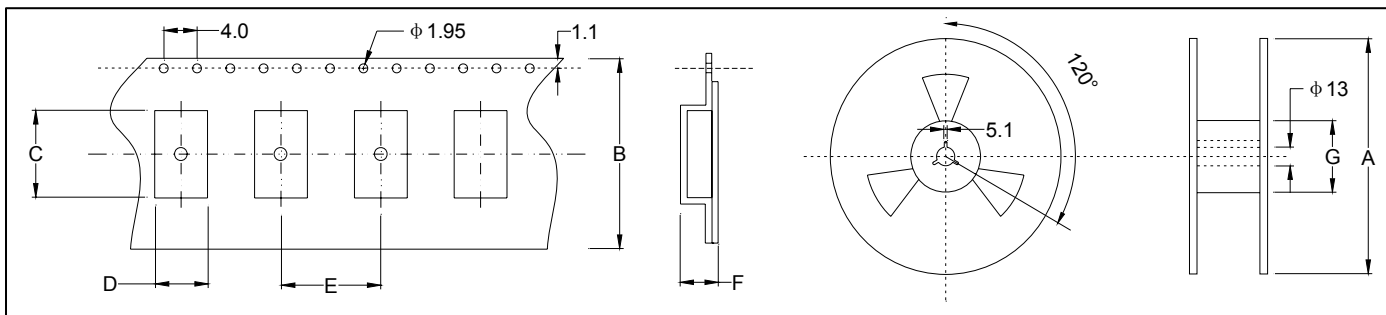

	A	B	C	D	E	F	G
SMD3225	178±2.0	8.03±0.3	3.81±0.10	3.04±0.10	3.84±0.1	1.54±0.10	62.0±1.0
3000 pcs per reel							

★ REFLOW SOLDERING PROFILE 回流焊特性

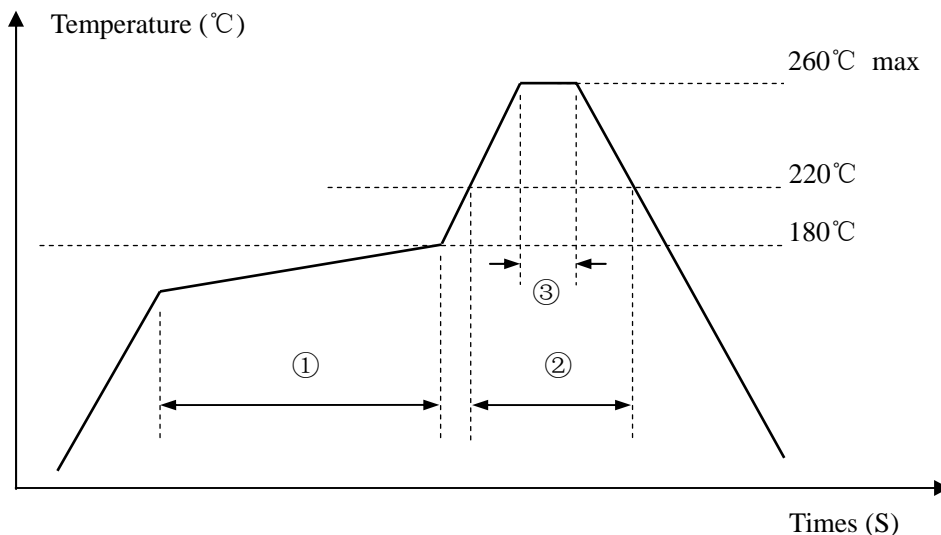

Pb free reflow A	①	Preheat	160~180°C	120sec. max
	②	Primary heat	220°C	60sec. max
	③	Peak	260°C	10sec. max.