

LM20242 Evaluation Board

National Semiconductor
Application Note 1694
Steven Schulte
October 30, 2007



Introduction

The LM20242 synchronous rectifier Buck evaluation board is designed to provide the design engineer with a fully functional Buck power converter based on Current Mode Control to evaluate the LM20242 switching regulator IC. The evaluation board provides a 3.3V output with 2A current capability. The input voltage ranges from 8V to 36V. The design operates at 300 kHz, a good compromise between conversion efficiency and solution size. The printed circuit board consists of 2 layers of 2 ounce copper on FR4 material with a thickness of 0.062 inches. This application note contains the evaluation board schematic, Bill-of-Materials (BOM) and a quick setup procedure. Refer to the LM20242 datasheet for complete circuit design information.

The performance of the synchronous rectifier buck evaluation board is as follows:

- Input Range: 8V to 36V
- Output Voltage: 3.3V, $\pm 2\%$
- Output Current: 0 to 2A
- Frequency of Operation: 300 kHz
- Board Size: 2.15 X 2.0 X 0.6 inches
- Load Regulation: 0.1%
- Line Regulation: 0.1%
- Over Current Limiting

Evaluation Board Schematic

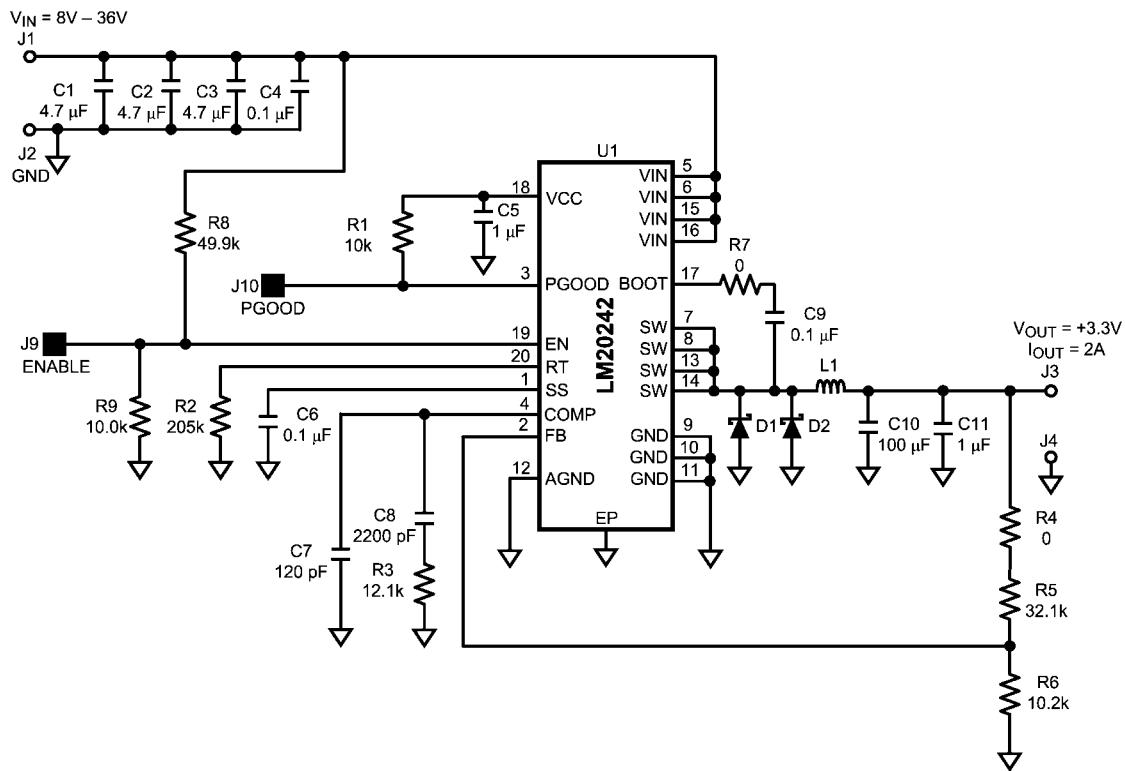

30033201

Powering and Loading Considerations

Read this entire page prior to attempting to power the evaluation board.

QUICK SETUP PROCEDURE

Step 1: Set the input source current limit to 1A. Turn off the input source. Connect the positive output of the input source to J1 and the negative output to J2.

Step 2: Connect the load, with 2A capability, to J3 for the positive connection and J4 for the negative connection.

Step 3: The ENABLE pin, J9, should be left open for normal operation.

Step 4: Set the input source voltage to 12V and the load to 0.1A. The load voltage should be in regulation with a nominal 3.3V output.

Step 5: Slowly increase the load while monitoring the load voltage at J3 and J4. It should remain in regulation with a nominal 3.3V output as the load is increased up to 2 Amp.

Step 6: Slowly sweep the input source voltage from 8V to 36V. The load voltage should remain in regulation with a nominal 3.3V output.

Step 7: Temporally short the ENABLE pin (J9) to GND (J2) to check the shutdown function.

Step 8: Increase the load beyond the normal range to check current limiting while the input source is set to 12V. The output current should limit at approximately 3.8A. The input source current limit should be increased for this step. Fan cooling is critical during this step.

AIR FLOW

Prolonged operation at full power and high ambient temperature will cause the thermal shutdown circuit within the regulator IC to activate. A fan with a minimum of 200 LFM should always be provided.

POWERING UP

Using the ENABLE pin (J9) provided will allow powering up the input source with the current level set low. It is suggested that the load power be kept low during the first power up. Set the current limit of the input source to provide about 1.5 times the anticipated wattage of the load. As you remove the connection from the ENABLE pin to GND (J2), immediately check for 3.3 volts at the output.

A quick efficiency check is the best way to confirm that everything is operating properly. If something is amiss you can be reasonably sure that it will affect the efficiency adversely. Few parameters can be incorrect in a switching power supply without creating losses and potentially damaging heat.

OVER CURRENT PROTECTION

The evaluation board is configured with cycle-by-cycle over-current protection. This function is completely contained in the LM20242. The peak current is limited to approximately 3.8A. The thermal stress on various circuit components is quite severe while in an overloaded condition, therefore limit the duration of the overload and provide sufficient cooling (air-flow).

Performance Characteristics

EFFICIENCY PLOTS

Figure 1 shows the conversion efficiency versus output current for several input voltage conditions.

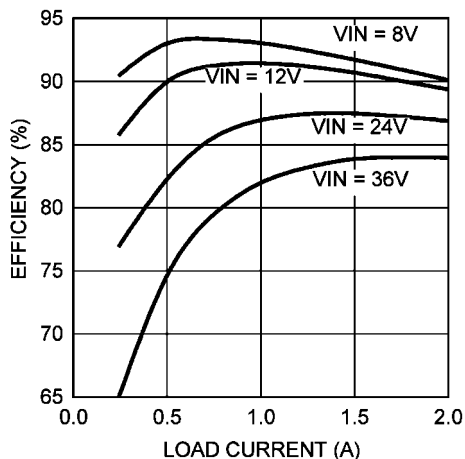

30033202

FIGURE 1.

TURN-ON WAVEFORM

When applying power to the LM20242 evaluation board a soft-start sequence occurs. Figure 2 shows the output voltage during a typical start-up sequence.

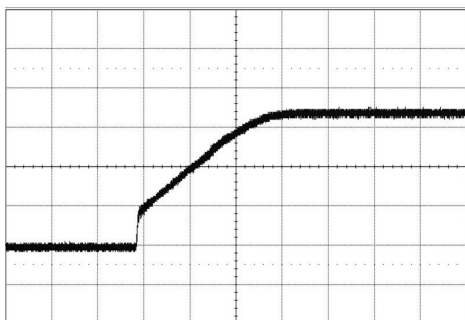

30033203

Conditions: Input Voltage = 12VDC, Output Current = 2A
Trace 1: Output Voltage Volts/div = 1V
Horizontal Resolution = 5ms/div

FIGURE 2.

OUTPUT RIPPLE WAVEFORM

Figure 3 shows the output voltage ripple. This measurement was taken with the scope probe tip placed on the J3 load terminal and the scope probe ground "barrel" pushed against the J4 load terminal. The scope bandwidth is set to 20 MHz.

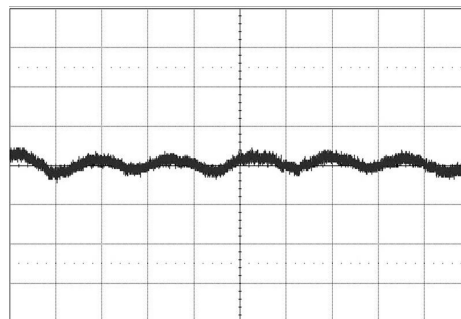

30033204

Conditions: Input Voltage = 12VDC, Output Current = 2A,
Bandwidth Limit = 20 MHz
Trace 1: Output Ripple Voltage Volts/div = 20 mV
Horizontal Resolution = 2 μ s/div

FIGURE 3.

PRIMARY SWITCHNODE WAVEFORM

FIGURE 4 shows the typical SW pin voltage during continuous conduction mode (CCM).

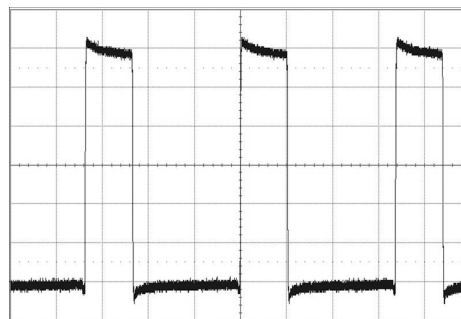

30033205

Conditions: Input Voltage = 12VDC, Output Current = 2A,
Bandwidth Limit = 20 MHz
Trace 1: LM20242 SW Pin Volts/div = 2V
Horizontal Resolution = 1 μ s/div

FIGURE 4.

Layout and Bill of Materials

The Bill of Materials is shown below, including the manufacturer and part number.

TABLE 1.

DESIGNATOR	QTY	PART NUMBER	DESCRIPTION	VALUE
C1-3	3	GRM32ER71H475KA88L	CAPACITOR, 1210 X7R CER, MURATA	4.7 μ , 50V
C4	1	C2012X7R2A104K	CAPACITOR, 0805 X7R CER, TDK	0.1 μ , 100V
C5	1	GRM188R71A105KA61D	CAPACITOR, 0603 X7R CER, MURATA	1 μ , 10V
C6,9	2	C1608X7R1H104K	CAPACITOR, 0603 X7R CER, TDK	0.1 μ , 50V
C7	1	C1608C0G1H121J	CAPACITOR, 0603 COG CER, TDK	120p, 50V
C8	1	C1608C0G1H222J	CAPACITOR, 0603 COG CER, TDK	2200p, 50V
C10	1	C1210C107M9PAC	CAPACITOR, 1210 X5R CER, KEMET	100 μ , 6.3V
C11	1	GRM21BR71H105KA12L	CAPACITOR, 0805 X7R CER, MURATA	1 μ , 50V
D1,2	2	MBR0540	DIODE, SCHOTTKY, SOD123, FAIRCHILD	500 mA, 40V
L1	1	MSS1278-153ML	INDUCTOR, COILCRAFT 12 mm x 12 mm	15 μ H, 3.5A
R1,9	2	CRCW06031002F	RESISTOR, 0603, VISHAY	10k
R2	1	CRCW06032053F	RESISTOR, 0603, VISHAY	205k
R3	1	CRCW06031212F	RESISTOR, 0603, VISHAY	12.1k
R4,7	2	CRCW06030000Z0EA	RESISTOR, 0603, VISHAY	0
R5	1	CRCW06033212F	RESISTOR, 0603, VISHAY	32.1k
R6	1	CRCW06031022F	RESISTOR, 0603, VISHAY	10.2k
R8	1	CRCW06034992F	RESISTOR, 0603, VISHAY	49.9k
U1	1	LM20242MH	SWITCHING REGULATOR, NATIONAL SEMI	
J1,2,3,4	4	1503-2	0.112" TURRET TERMINAL, KEYSTONE	TERMINAL, TURRET
J9,10	2	5002	TERMINAL, SINGLE PIN, KEYSTONE	TESTPOINT, LOOP

PCB Layout

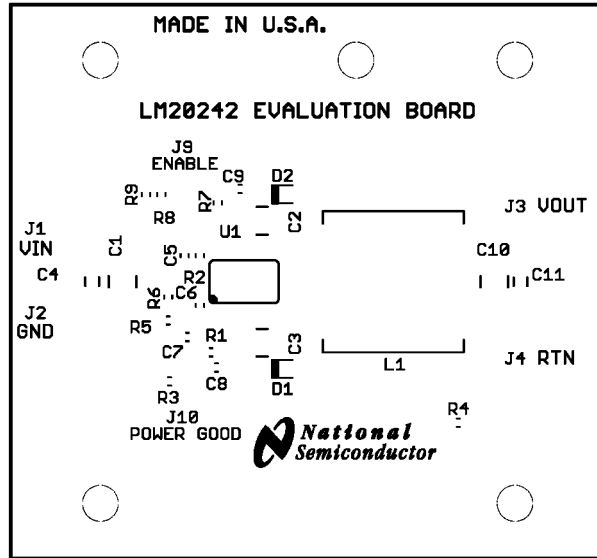

Silkscreen

30033206

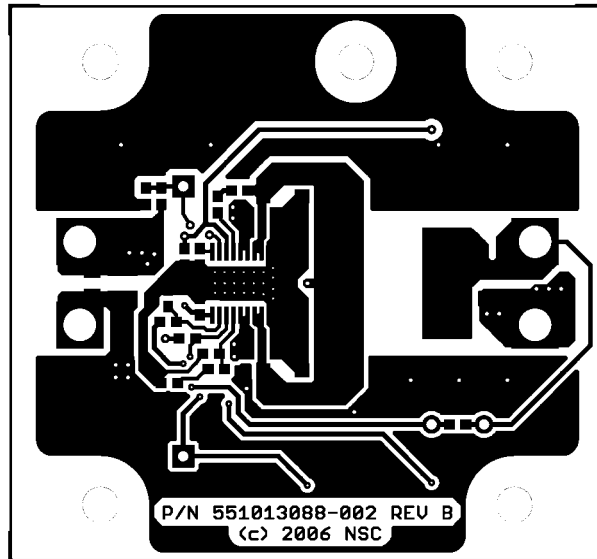

Component Side

30033207

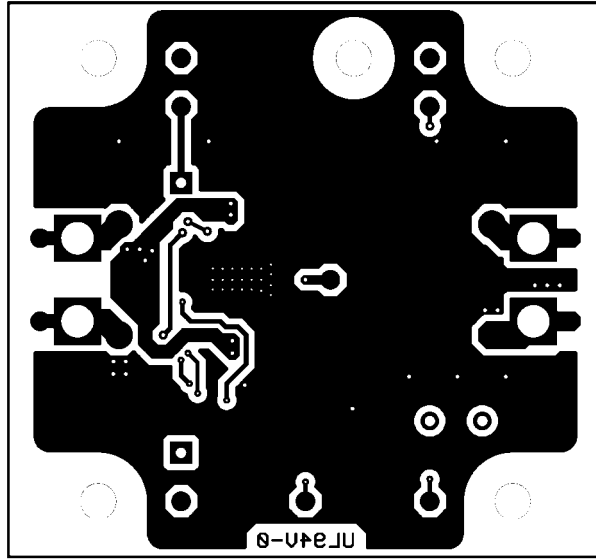

Solder Side

30033208

Notes

For more National Semiconductor product information and proven design tools, visit the following Web sites at:

Products		Design Support	
Amplifiers	www.national.com/amplifiers	WEBENCH	www.national.com/webench
Audio	www.national.com/audio	Analog University	www.national.com/AU
Clock Conditioners	www.national.com/timing	App Notes	www.national.com/appnotes
Data Converters	www.national.com/adc	Distributors	www.national.com/contacts
Displays	www.national.com/displays	Green Compliance	www.national.com/quality/green
Ethernet	www.national.com/ethernet	Packaging	www.national.com/packaging
Interface	www.national.com/interface	Quality and Reliability	www.national.com/quality
LVDS	www.national.com/lvds	Reference Designs	www.national.com/refdesigns
Power Management	www.national.com/power	Feedback	www.national.com/feedback
Switching Regulators	www.national.com/switchers		
LDOs	www.national.com/ldo		
LED Lighting	www.national.com/led		
PowerWise	www.national.com/powerwise		
Serial Digital Interface (SDI)	www.national.com/sdi		
Temperature Sensors	www.national.com/tempsensors		
Wireless (PLL/VCO)	www.national.com/wireless		

THE CONTENTS OF THIS DOCUMENT ARE PROVIDED IN CONNECTION WITH NATIONAL SEMICONDUCTOR CORPORATION ("NATIONAL") PRODUCTS. NATIONAL MAKES NO REPRESENTATIONS OR WARRANTIES WITH RESPECT TO THE ACCURACY OR COMPLETENESS OF THE CONTENTS OF THIS PUBLICATION AND RESERVES THE RIGHT TO MAKE CHANGES TO SPECIFICATIONS AND PRODUCT DESCRIPTIONS AT ANY TIME WITHOUT NOTICE. NO LICENSE, WHETHER EXPRESS, IMPLIED, ARISING BY ESTOPPEL OR OTHERWISE, TO ANY INTELLECTUAL PROPERTY RIGHTS IS GRANTED BY THIS DOCUMENT.

TESTING AND OTHER QUALITY CONTROLS ARE USED TO THE EXTENT NATIONAL DEEMS NECESSARY TO SUPPORT NATIONAL'S PRODUCT WARRANTY. EXCEPT WHERE MANDATED BY GOVERNMENT REQUIREMENTS, TESTING OF ALL PARAMETERS OF EACH PRODUCT IS NOT NECESSARILY PERFORMED. NATIONAL ASSUMES NO LIABILITY FOR APPLICATIONS ASSISTANCE OR BUYER PRODUCT DESIGN. BUYERS ARE RESPONSIBLE FOR THEIR PRODUCTS AND APPLICATIONS USING NATIONAL COMPONENTS. PRIOR TO USING OR DISTRIBUTING ANY PRODUCTS THAT INCLUDE NATIONAL COMPONENTS, BUYERS SHOULD PROVIDE ADEQUATE DESIGN, TESTING AND OPERATING SAFEGUARDS.

EXCEPT AS PROVIDED IN NATIONAL'S TERMS AND CONDITIONS OF SALE FOR SUCH PRODUCTS, NATIONAL ASSUMES NO LIABILITY WHATSOEVER, AND NATIONAL DISCLAIMS ANY EXPRESS OR IMPLIED WARRANTY RELATING TO THE SALE AND/OR USE OF NATIONAL PRODUCTS INCLUDING LIABILITY OR WARRANTIES RELATING TO FITNESS FOR A PARTICULAR PURPOSE, MERCHANTABILITY, OR INFRINGEMENT OF ANY PATENT, COPYRIGHT OR OTHER INTELLECTUAL PROPERTY RIGHT.

LIFE SUPPORT POLICY

NATIONAL'S PRODUCTS ARE NOT AUTHORIZED FOR USE AS CRITICAL COMPONENTS IN LIFE SUPPORT DEVICES OR SYSTEMS WITHOUT THE EXPRESS PRIOR WRITTEN APPROVAL OF THE CHIEF EXECUTIVE OFFICER AND GENERAL COUNSEL OF NATIONAL SEMICONDUCTOR CORPORATION. As used herein:

Life support devices or systems are devices which (a) are intended for surgical implant into the body, or (b) support or sustain life and whose failure to perform when properly used in accordance with instructions for use provided in the labeling can be reasonably expected to result in a significant injury to the user. A critical component is any component in a life support device or system whose failure to perform can be reasonably expected to cause the failure of the life support device or system or to affect its safety or effectiveness.

National Semiconductor and the National Semiconductor logo are registered trademarks of National Semiconductor Corporation. All other brand or product names may be trademarks or registered trademarks of their respective holders.

Copyright© 2007 National Semiconductor Corporation

For the most current product information visit us at www.national.com



**National Semiconductor
Americas Customer
Support Center**
Email:
new.feedback@nsc.com
Tel: 1-800-272-9959

**National Semiconductor Europe
Customer Support Center**
Fax: +49 (0) 180-530-85-86
Email: europe.support@nsc.com
Deutsch Tel: +49 (0) 69 9508 6208
English Tel: +49 (0) 870 24 0 2171
Français Tel: +33 (0) 1 41 91 8790

**National Semiconductor Asia
Pacific Customer Support Center**
Email: ap.support@nsc.com

**National Semiconductor Japan
Customer Support Center**
Fax: 81-3-5639-7507
Email: jpn.feedback@nsc.com
Tel: 81-3-5639-7560