

# CSD86330Q3D Synchronous Buck NexFET™ Power Block

## 1 Features

- Half-Bridge Power Block
- 90% System Efficiency at 15 A
- Up to 20 A Operation
- High Frequency Operation (Up To 1.5 MHz)
- High Density – SON 3.3 mm x 3.3 mm Footprint
- Optimized for 5 V Gate Drive
- Low Switching Losses
- Ultra Low Inductance Package
- RoHS Compliant
- Halogen Free
- Pb-Free Terminal Plating

## 2 Applications

- Synchronous Buck Converters
  - High Frequency Applications
  - High Current, Low Duty Cycle Applications
- Multiphase Synchronous Buck Converters
- POL DC-DC Converters
- IMVP, VRM, and VRD Applications

## 3 Description

The CSD86330Q3D NexFET™ power block is an optimized design for synchronous buck applications offering high current, high efficiency, and high frequency capability in a small 3.3 mm x 3.3 mm outline. Optimized for 5 V gate drive applications, this product offers a flexible solution capable of offering a high density power supply when paired with any 5 V gate drive from an external controller/driver.

Top View

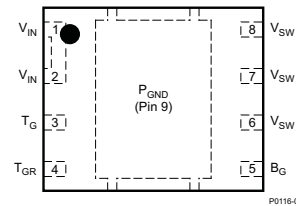

Ordering Information<sup>(1)</sup>

Device	Media	Qty	Package	Ship
CSD86330Q3D	13-Inch Reel	2500	SON 3.3 mm x 3.3 mm Plastic Package	Tape and Reel
CSD86330Q3DT	7-Inch Reel	250		

(1) For all available packages, see the orderable addendum at the end of the data sheet.

$R_{DS(on)}$  vs  $V_{GS}$

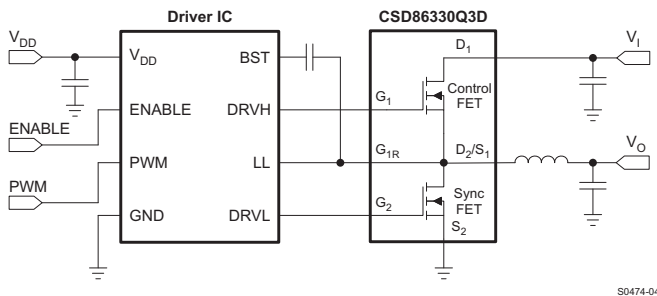

Gate Charge

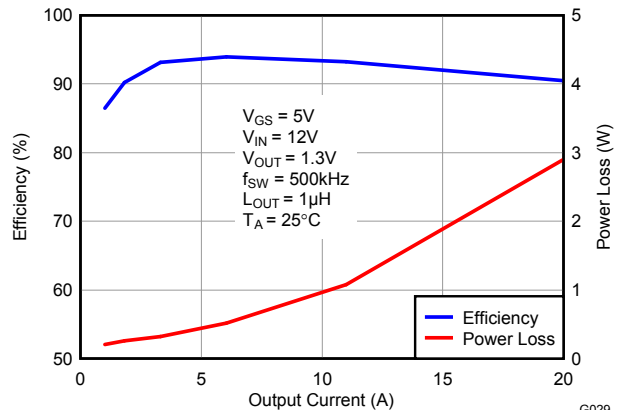

G029



## Table of Contents

<b>1 Features</b> .....	<b>1</b>	6.3 Safe Operating Curves (SOA) .....	<b>12</b>
<b>2 Applications</b> .....	<b>1</b>	6.4 Normalized Curves.....	<b>12</b>
<b>3 Description</b> .....	<b>1</b>	6.5 Calculating Power Loss and SOA .....	<b>14</b>
<b>4 Revision History</b> .....	<b>2</b>	<b>7 Recommended PCB Design Overview</b> .....	<b>15</b>
<b>5 Specifications</b> .....	<b>3</b>	7.1 Electrical Performance.....	<b>15</b>
5.1 Absolute Maximum Ratings .....	<b>3</b>	7.2 Thermal Performance .....	<b>15</b>
5.2 Recommended Operating Conditions.....	<b>3</b>	<b>8 Device and Documentation Support</b> .....	<b>17</b>
5.3 Thermal Information .....	<b>3</b>	8.1 Trademarks .....	<b>17</b>
5.4 Power Block Performance .....	<b>3</b>	8.2 Electrostatic Discharge Caution.....	<b>17</b>
5.5 Electrical Characteristics.....	<b>4</b>	8.3 Glossary .....	<b>17</b>
5.6 Typical Power Block Device Characteristics.....	<b>5</b>	<b>9 Mechanical, Packaging, and Orderable Information</b> .....	<b>18</b>
5.7 Typical Power Block MOSFET Characteristics.....	<b>7</b>	9.1 Q3D Package Dimensions.....	<b>18</b>
<b>6 Application and Implementation</b> .....	<b>10</b>	9.2 Land Pattern Recommendation .....	<b>19</b>
6.1 Application Information.....	<b>10</b>	9.3 Stencil Recommendation .....	<b>19</b>
6.2 Power Loss Curves .....	<b>12</b>	9.4 Q3D Tape and Reel Information.....	<b>20</b>

## 4 Revision History

NOTE: Page numbers for previous revisions may differ from page numbers in the current version.

### Changes from Revision C (October 2011) to Revision D

Page

- Corrected 125°C line in [Figure 20](#) to agree with data in [Figure 22](#) ..... **8**
- Corrected 125°C line in [Figure 21](#) to agree with data in [Figure 23](#) ..... **8**

### Changes from Revision B (September 2011) to Revision C

Page

- Changed "DIM A" Millimeter Max value From: 1.55 To: 1.5 and Inches Max value From: 0.061 To: 0.059 ..... **18**

### Changes from Revision A (December 2010) to Revision B

Page

- Change  $R_{DS(on)}$  to  $Z_{DS(on)}$  .....
 **4** |- Added *Equivalent System Performance* section .....
 **10** |- Added Electrical Performance bullet .....
 **15** |

### Changes from Original (October 2010) to Revision A

Page

- Changed  $I_{OUT}$  Conditions From: 20A To: 15A, and the TYP value From: 2.9W To: 1.9W..... **3**

## 5 Specifications

### 5.1 Absolute Maximum Ratings

 $T_A = 25^\circ\text{C}$  (unless otherwise noted)<sup>(1)</sup>

		MIN	MAX	UNIT
Voltage range	$V_{IN}$ to $P_{GND}$	-0.8	25	V
	$T_G$ to $T_{GR}$	-8	10	V
	$B_G$ to $P_{GND}$	-8	10	V
Pulsed Current Rating, $I_{DM}$			60	A
Power Dissipation, $P_D$			6	W
Avalanche Energy $E_{AS}$	Sync FET, $I_D = 65\text{ A}$ , $L = 0.1\text{ mH}$		211	mJ
	Control FET, $I_D = 42\text{ A}$ , $L = 0.1\text{ mH}$		88	
Operating junction, $T_J$		-55	150	$^\circ\text{C}$
Storage temperature, $T_{stg}$		-55	150	$^\circ\text{C}$

(1) Stresses beyond those listed under Absolute Maximum Ratings may cause permanent damage to the device. These are stress ratings only, and functional operation of the device at these or any other conditions beyond those indicated is not implied. Exposure to absolute-maximum-rated conditions for extended periods may affect device reliability.

### 5.2 Recommended Operating Conditions

 $T_A = 25^\circ$  (unless otherwise noted)

		MIN	MAX	UNIT
Gate drive voltage, $V_{GS}$		4.5	8	V
Input supply voltage, $V_{IN}$			22	V
Switching frequency, $f_{SW}$	$C_{BST} = 0.1\ \mu\text{F}$ (min)	200	1500	kHz
Operating current			20	A
Operating temperature, $T_J$			125	$^\circ\text{C}$

### 5.3 Thermal Information

 $T_A = 25^\circ\text{C}$  (unless otherwise stated)

THERMAL METRIC		MIN	TYP	MAX	UNIT
$R_{\theta JA}$	Junction-to-ambient thermal resistance (Min Cu) <sup>(1)</sup>			135	$^\circ\text{C/W}$
	Junction-to-ambient thermal resistance (Max Cu) <sup>(1)(2)</sup>			73	
$R_{\theta JC}$	Junction-to-case thermal resistance (Top of package) <sup>(1)</sup>			29	
	Junction-to-case thermal resistance ( $P_{GND}$ Pin) <sup>(1)</sup>			2.5	

(1)  $R_{\theta JC}$  is determined with the device mounted on a 1 inch<sup>2</sup> (6.45 cm<sup>2</sup>), 2 oz. (0.071 mm thick) Cu pad on a 1.5 inches x 1.5 inches (3.81 cm x 3.81 cm), 0.06 inch (1.52 mm) thick FR4 board.  $R_{\theta JC}$  is specified by design while  $R_{\theta JA}$  is determined by the user's board design.

(2) Device mounted on FR4 material with 1 inch<sup>2</sup> (6.45 cm<sup>2</sup>) Cu.

### 5.4 Power Block Performance

 $T_A = 25^\circ$  (unless otherwise noted)

PARAMETER	TEST CONDITIONS	MIN	TYP	MAX	UNIT
Power Loss, $P_{LOSS}$ <sup>(1)</sup>	$V_{IN} = 12\text{ V}$ , $V_{GS} = 5\text{ V}$ , $V_{OUT} = 1.3\text{ V}$ , $I_{OUT} = 15\text{ A}$ , $f_{SW} = 500\text{ kHz}$ , $L_{OUT} = 1\ \mu\text{H}$ , $T_J = 25^\circ\text{C}$		1.9		W
$V_{IN}$ Quiescent Current, $I_{QVIN}$	$T_G$ to $T_{GR} = 0\text{ V}$ $B_G$ to $P_{GND} = 0\text{ V}$		10		$\mu\text{A}$

(1) Measurement made with six 10  $\mu\text{F}$  (TDK C3216X5R1C106KT or equivalent) ceramic capacitors placed across  $V_{IN}$  to  $P_{GND}$  pins and using a high current 5 V driver IC.

## 5.5 Electrical Characteristics

 $T_A = 25^\circ\text{C}$  (unless otherwise stated)

PARAMETER	TEST CONDITIONS	Q1 Control FET			Q2 Sync FET			UNIT			
		MIN	TYP	MAX	MIN	TYP	MAX				
<b>STATIC CHARACTERISTICS</b>											
$BV_{DSS}$	Drain-to-Source Voltage	$V_{GS} = 0\text{ V}, I_{DS} = 250\ \mu\text{A}$			25			V			
$I_{DSS}$	Drain-to-Source Leakage Current	$V_{GS} = 0\text{ V}, V_{DS} = 20\text{ V}$			1			$\mu\text{A}$			
$I_{GSS}$	Gate-to-Source Leakage Current	$V_{DS} = 0\text{ V}, V_{GS} = +10 / -8$			100			nA			
$V_{GS(th)}$	Gate-to-Source Threshold Voltage	$V_{DS} = V_{GS}, I_{DS} = 250\ \mu\text{A}$			0.9	1.4	2.1	0.9	1.1	1.6	V
$Z_{DS(on)}$	Effective AC On-Impedance	$V_{IN} = 12\text{ V}, V_{GS} = 5\text{ V}, V_{OUT} = 1.3\text{ V}, I_{OUT} = 15\text{ A}, f_{SW} = 500\text{ kHz}, L_{OUT} = 1\ \mu\text{H}$			8.8			3.3		$\text{m}\Omega$	
$g_{fs}$	Transconductance	$V_{DS} = 15\text{ V}, I_{DS} = 14\text{ A}$			52			82		S	
<b>DYNAMIC CHARACTERISTICS</b>											
$C_{ISS}$	Input Capacitance <sup>(1)</sup>	$V_{GS} = 0\text{ V}, V_{DS} = 12.5\text{ V}, f = 1\text{ MHz}$			710	920	1280		1660	pF	
$C_{OSS}$	Output Capacitance <sup>(1)</sup>				350	455	680		880		pF
$C_{RSS}$	Reverse Transfer Capacitance <sup>(1)</sup>				18	23	38		49		pF
$R_G$	Series Gate Resistance <sup>(1)</sup>	$V_{DS} = 12.5\text{ V}, I_{DS} = 14\text{ A}$			1.5	3.0	1.2		2.4	$\Omega$	
$Q_g$	Gate Charge Total (4.5 V) <sup>(1)</sup>				4.8	6.2	9.2		12		nC
$Q_{gd}$	Gate Charge - Gate-to-Drain				0.9		1.6				nC
$Q_{gs}$	Gate Charge - Gate-to-Source				1.6		2.1				nC
$Q_{g(th)}$	Gate Charge at $V_{th}$				0.9		1.2				nC
$Q_{OSS}$	Output Charge	$V_{DS} = 15.5\text{ V}, V_{GS} = 0\text{ V}$			7.2		13.6		nC		
$t_{d(on)}$	Turn On Delay Time	$V_{DS} = 12.5\text{ V}, V_{GS} = 4.5\text{ V}, I_{DS} = 14\text{ A}, R_G = 2\ \Omega$			4.9		5.3		ns		
$t_r$	Rise Time				7.5		6.3				ns
$t_{d(off)}$	Turn Off Delay Time				8.5		15.8				ns
$t_f$	Fall Time				1.9		4.2				ns
<b>DIODE CHARACTERISTICS</b>											
$V_{SD}$	Diode Forward Voltage	$I_{DS} = 14\text{ A}, V_{GS} = 0\text{ V}$			0.85	1	0.8		1	V	
$Q_{rr}$	Reverse Recovery Charge	$V_{dd} = 15.5\text{ V}, I_F = 14\text{ A}, di/dt = 300\text{ A}/\mu\text{s}$			3.9		7.3		nC		
$t_{rr}$	Reverse Recovery Time				13.9		19		ns		

(1) Specified by design

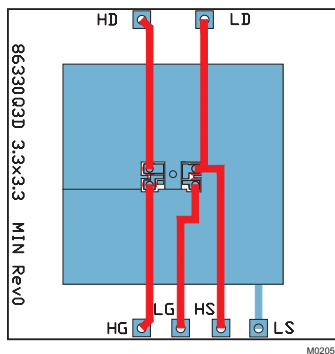

Max  $R_{\theta JA} = 76^\circ\text{C}/\text{W}$   
 when mounted on  
 1 inch<sup>2</sup> (6.45 cm<sup>2</sup>) of  
 2 oz. (0.071 mm thick)  
 Cu.

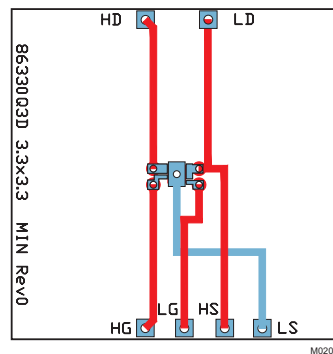

Max  $R_{\theta JA} = 140^\circ\text{C}/\text{W}$   
 when mounted on  
 minimum pad area of  
 2 oz. (0.071 mm thick)  
 Cu.

### 5.6 Typical Power Block Device Characteristics

$V_{IN} = 12\text{ V}$ ,  $V_{DD} = 5\text{ V}$ ,  $f_{SW} = 500\text{ kHz}$ ,  $V_{OUT} = 1.2\text{ V}$ ,  $L_{OUT} = 1.0\text{ }\mu\text{H}$ ,  $I_{OUT} = 20\text{ A}$ ,  $T_J = 125^\circ\text{C}$ , unless stated otherwise.

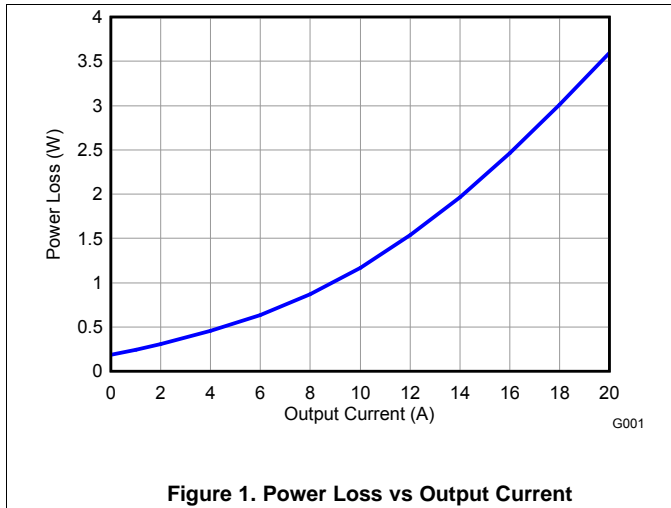

**Figure 1. Power Loss vs Output Current**

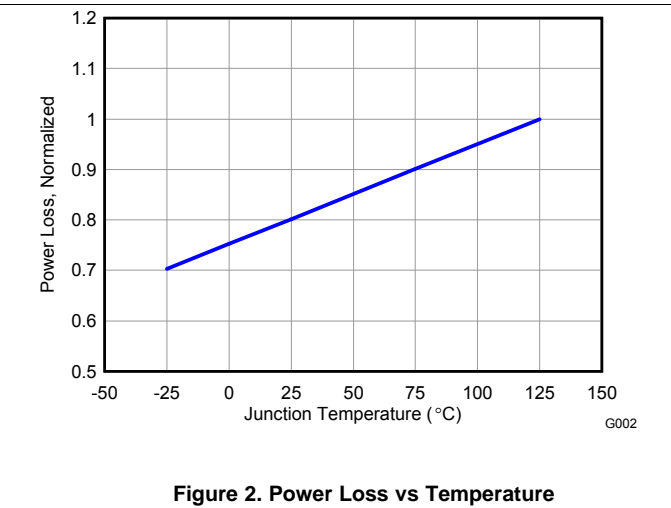

**Figure 2. Power Loss vs Temperature**

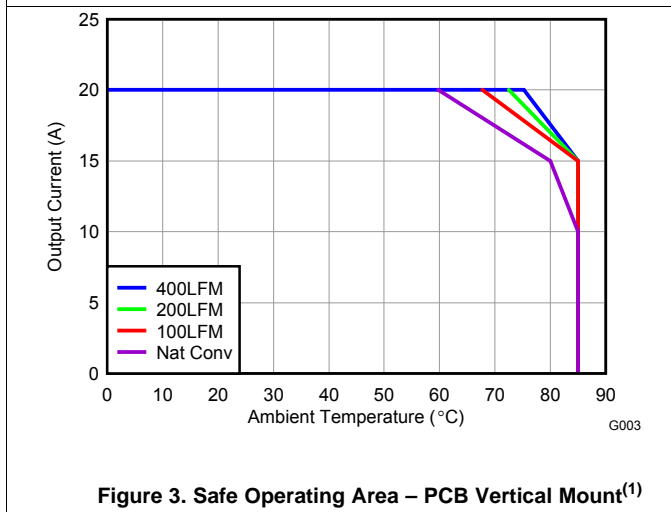

**Figure 3. Safe Operating Area – PCB Vertical Mount<sup>(1)</sup>**

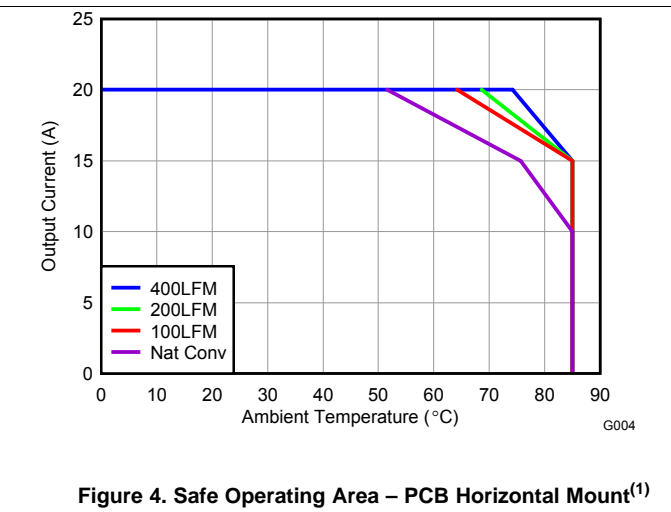
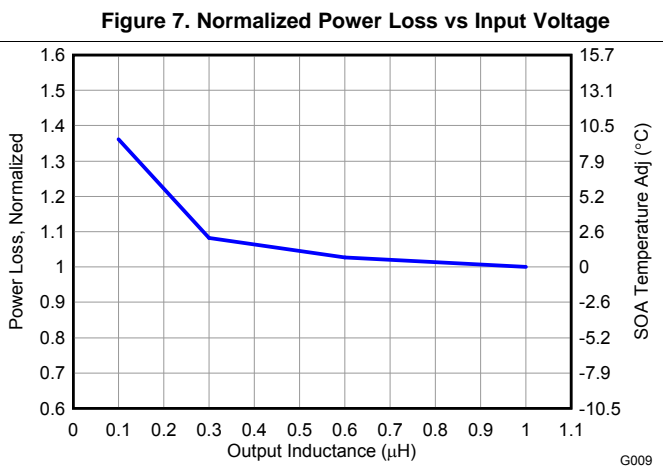
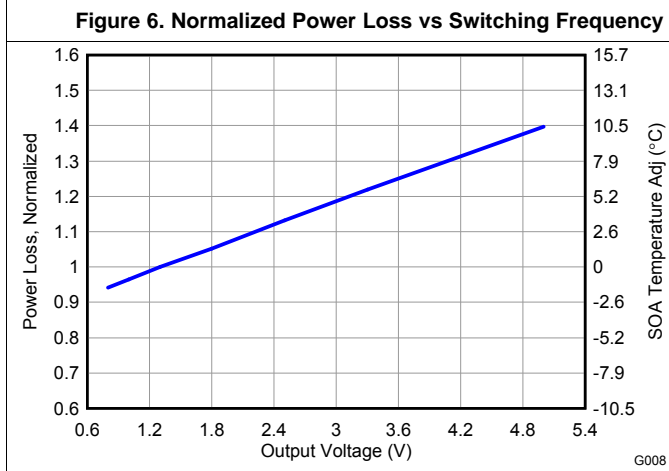
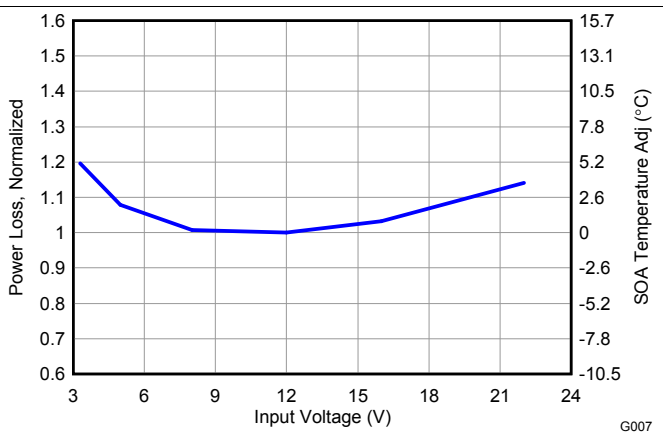
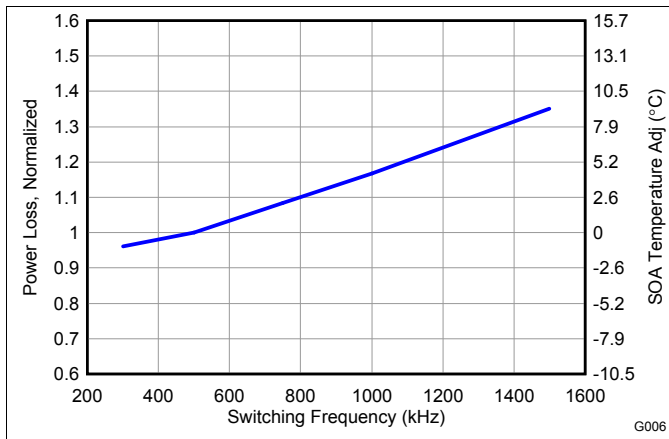
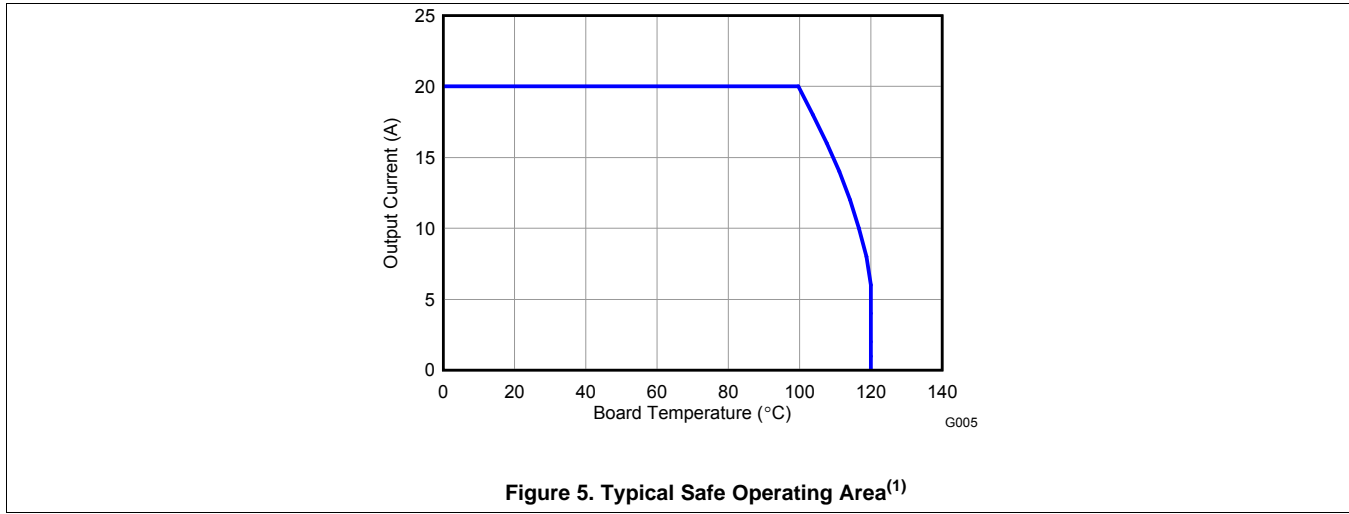

**Figure 4. Safe Operating Area – PCB Horizontal Mount<sup>(1)</sup>**

(1) The Typical Power Block System Characteristic curves are based on measurements made on a PCB design with dimensions of 4.0" (W) × 3.5" (L) × 0.062" (H) and 6 copper layers of 1 oz. copper thickness. See Application Section for detailed explanation.

**Typical Power Block Device Characteristics (continued)**

$V_{IN} = 12\text{ V}$ ,  $V_{DD} = 5\text{ V}$ ,  $f_{SW} = 500\text{ kHz}$ ,  $V_{OUT} = 1.2\text{ V}$ ,  $L_{OUT} = 1.0\text{ }\mu\text{H}$ ,  $I_{OUT} = 20\text{ A}$ ,  $T_J = 125^\circ\text{C}$ , unless stated otherwise.



### 5.7 Typical Power Block MOSFET Characteristics

$T_A = 25^\circ\text{C}$ , unless stated otherwise.

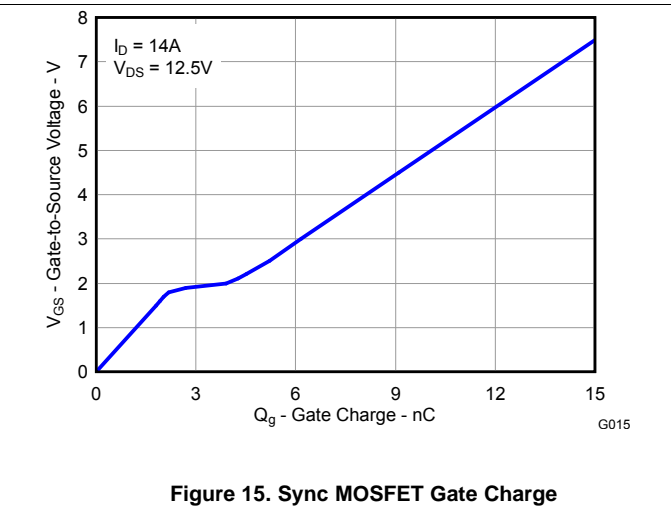
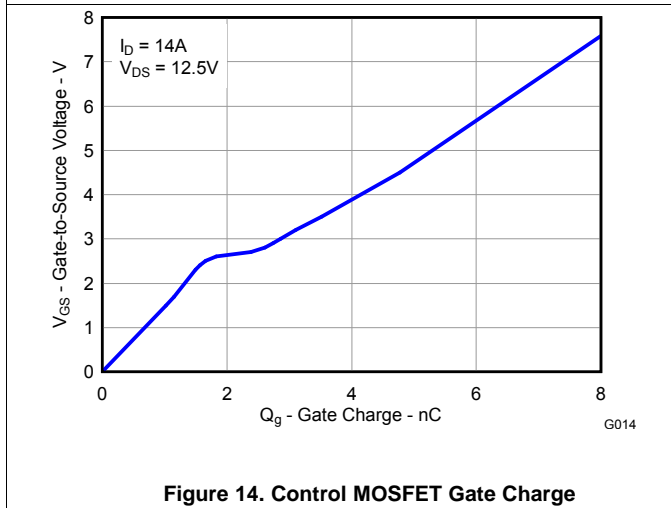
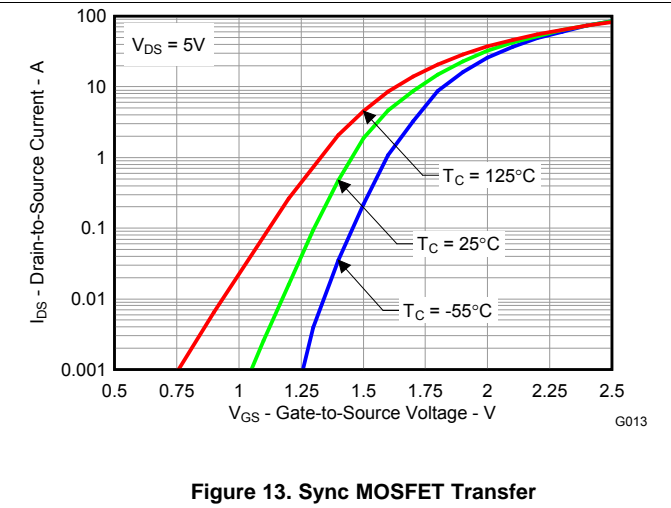
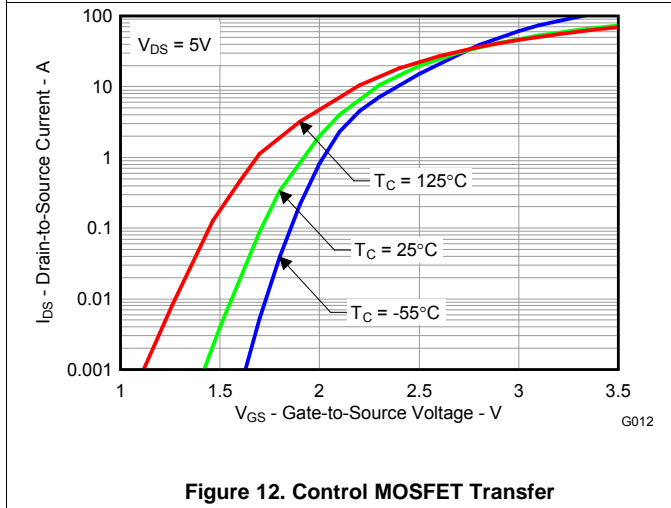
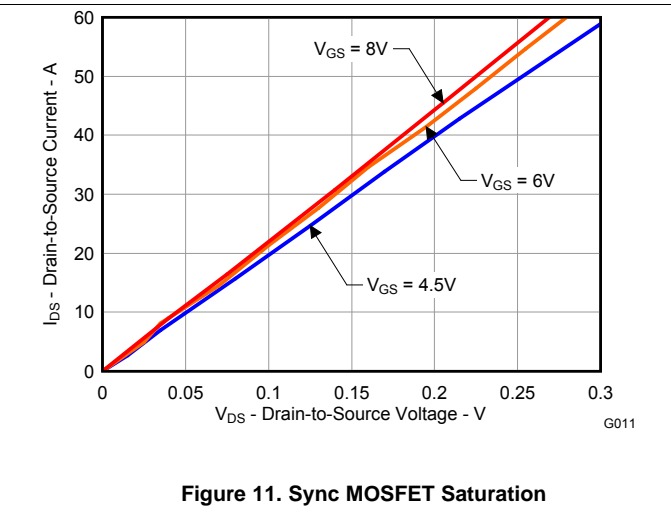
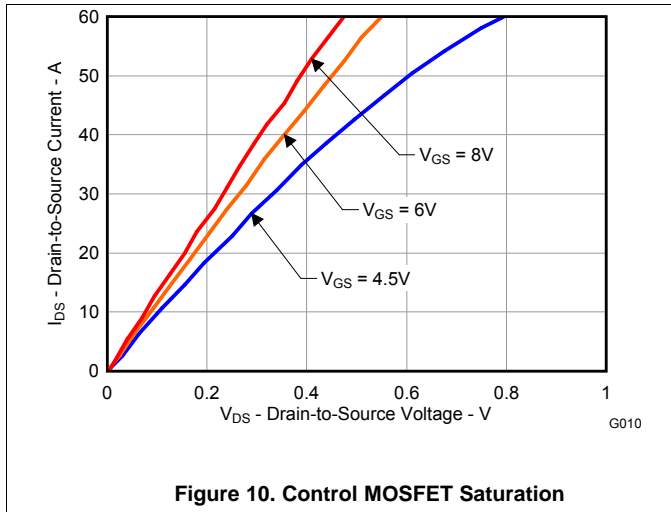

Typical Power Block MOSFET Characteristics (continued)

T<sub>A</sub> = 25°C, unless stated otherwise.

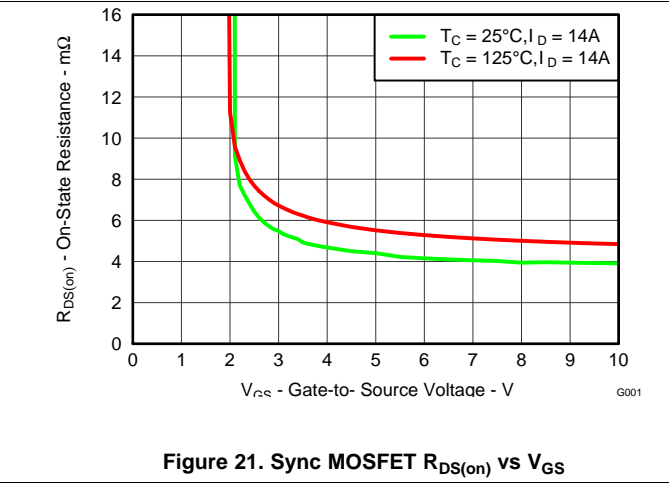
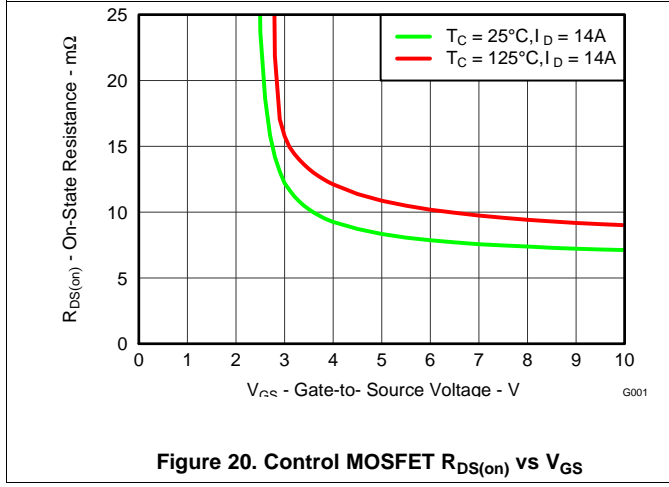
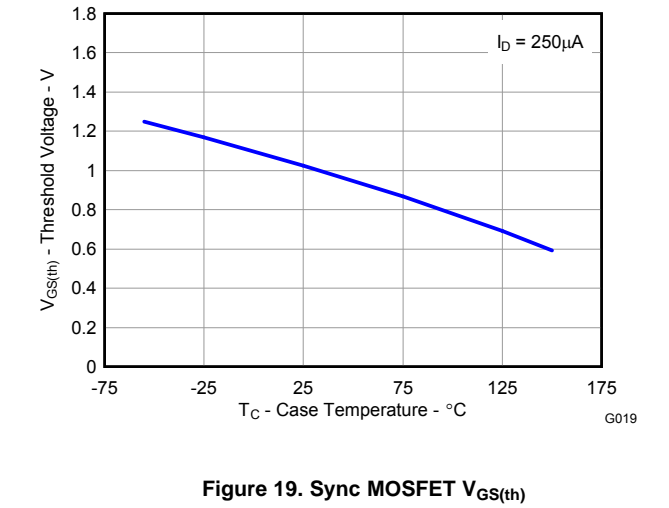
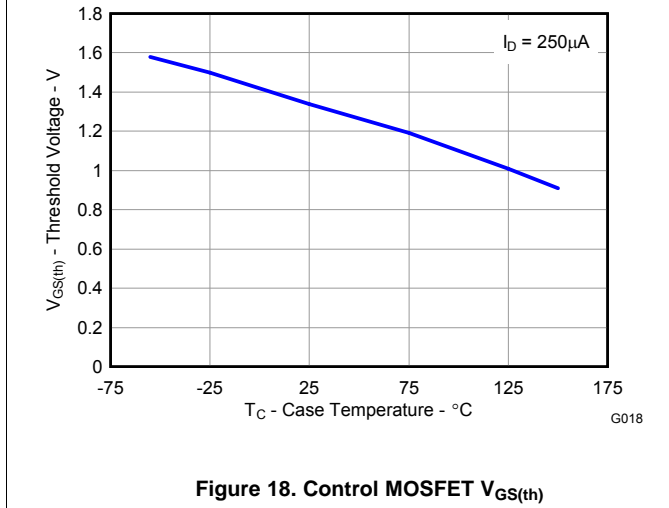
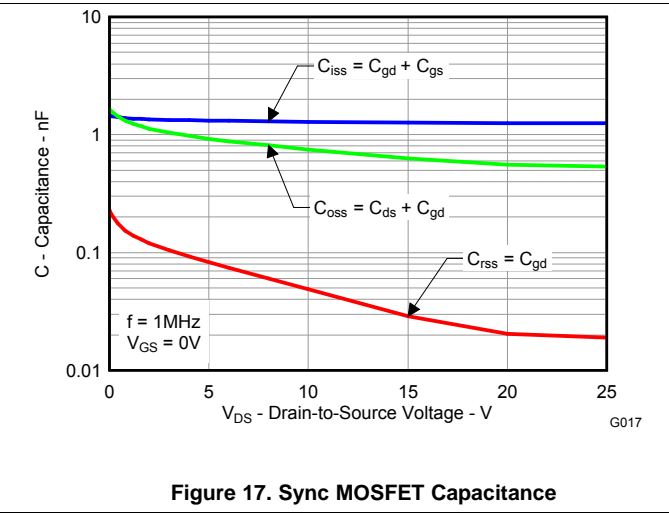
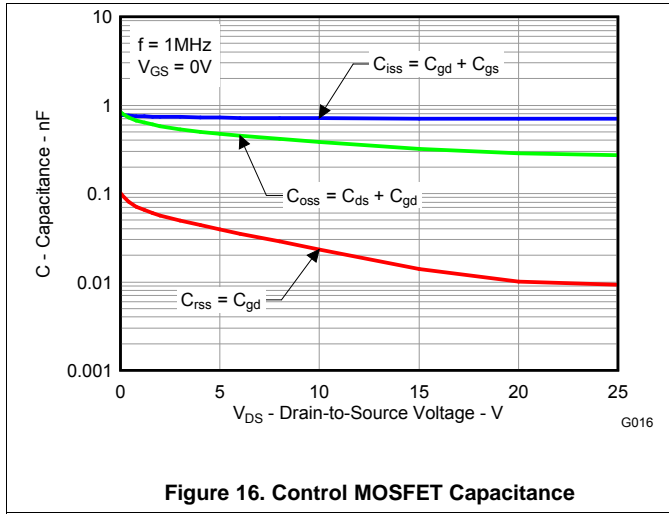



Typical Power Block MOSFET Characteristics (continued)

$T_A = 25^\circ\text{C}$ , unless stated otherwise.

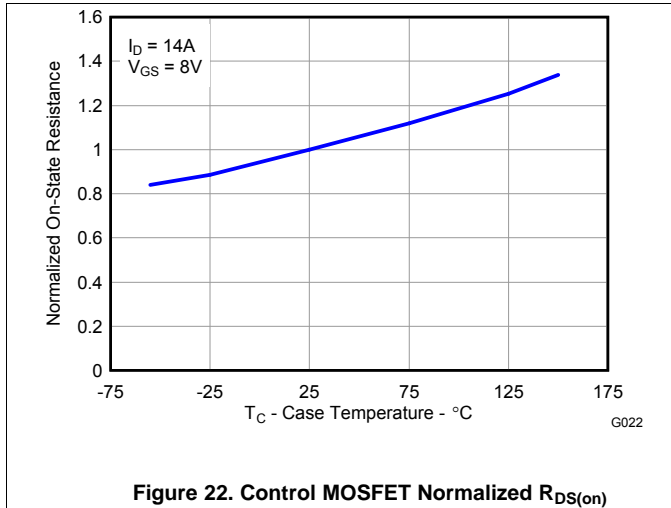

Figure 22. Control MOSFET Normalized  $R_{DS(on)}$

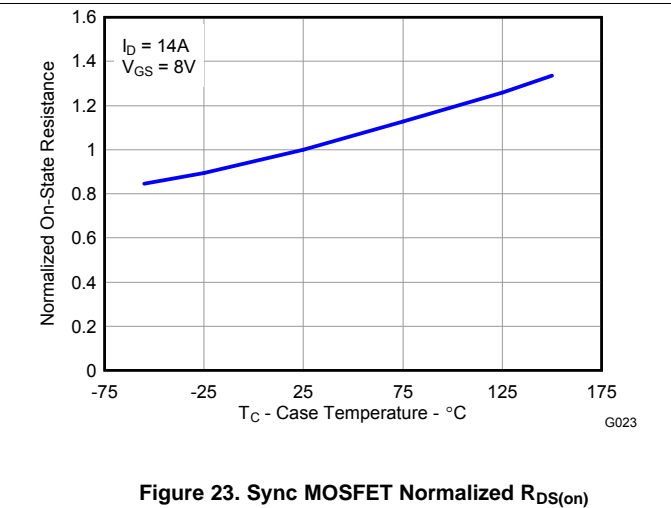

Figure 23. Sync MOSFET Normalized  $R_{DS(on)}$

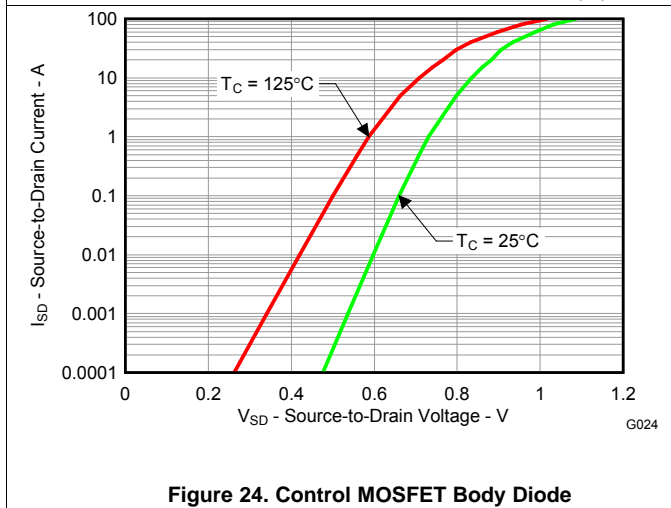

Figure 24. Control MOSFET Body Diode

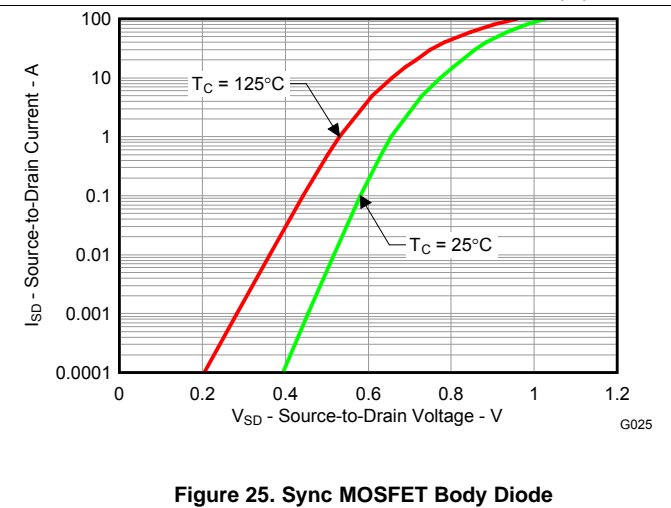

Figure 25. Sync MOSFET Body Diode

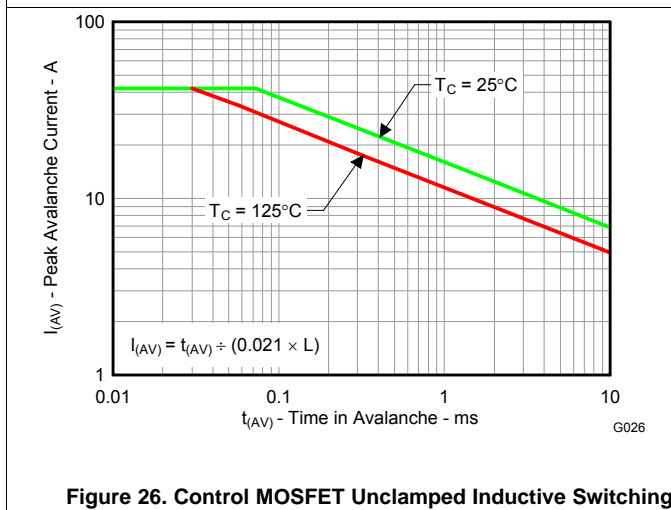

Figure 26. Control MOSFET Unclamped Inductive Switching

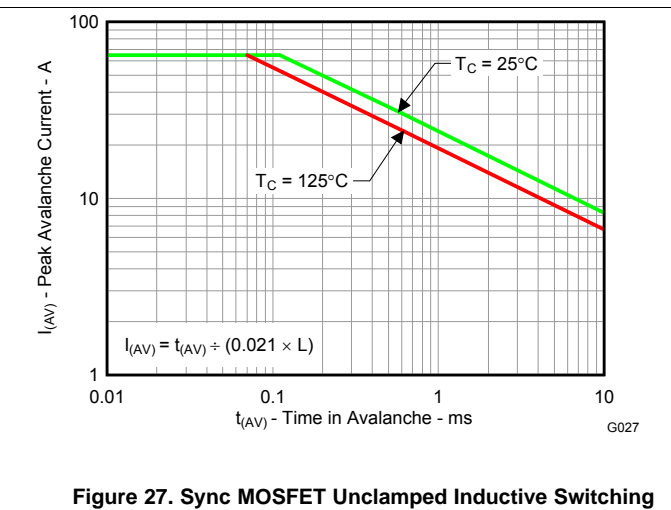

Figure 27. Sync MOSFET Unclamped Inductive Switching

## 6 Application and Implementation

### NOTE

Information in the following applications sections is not part of the TI component specification, and TI does not warrant its accuracy or completeness. TI's customers are responsible for determining suitability of components for their purposes. Customers should validate and test their design implementation to confirm system functionality.

### 6.1 Application Information

#### 6.1.1 Equivalent System Performance

Many of today's high performance computing systems require low power consumption in an effort to reduce system operating temperatures and improve overall system efficiency. This has created a major emphasis on improving the conversion efficiency of today's Synchronous Buck Topology. In particular, there has been an emphasis in improving the performance of the critical Power Semiconductor in the Power Stage of this Application (see [Figure 28](#)). As such, optimization of the power semiconductors in these applications, needs to go beyond simply reducing  $R_{DS(ON)}$ .

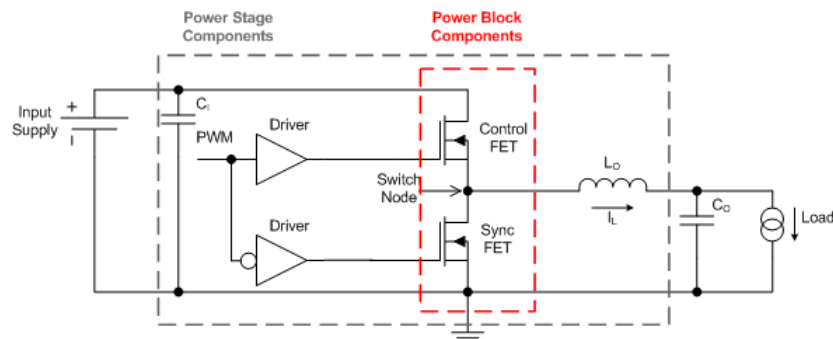

**Figure 28.**

The CSD86330Q3D is part of TI's Power Block product family which is a highly optimized product for use in a synchronous buck topology requiring high current, high efficiency, and high frequency. It incorporates TI's latest generation silicon which has been optimized for switching performance, as well as minimizing losses associated with  $Q_{GD}$ ,  $Q_{GS}$ , and  $Q_{RR}$ . Furthermore, TI's patented packaging technology has minimized losses by nearly eliminating parasitic elements between the Control FET and Sync FET connections (see [Figure 29](#)). A key challenge solved by TI's patented packaging technology is the system level impact of Common Source Inductance (CSI). CSI greatly impedes the switching characteristics of any MOSFET which in turn increases switching losses and reduces system efficiency. As a result, the effects of CSI need to be considered during the MOSFET selection process. In addition, standard MOSFET switching loss equations used to predict system efficiency need to be modified in order to account for the effects of CSI. Further details behind the effects of CSI and modification of switching loss equations are outlined in TI's Application Note [SLPA009](#).

**Application Information (continued)**

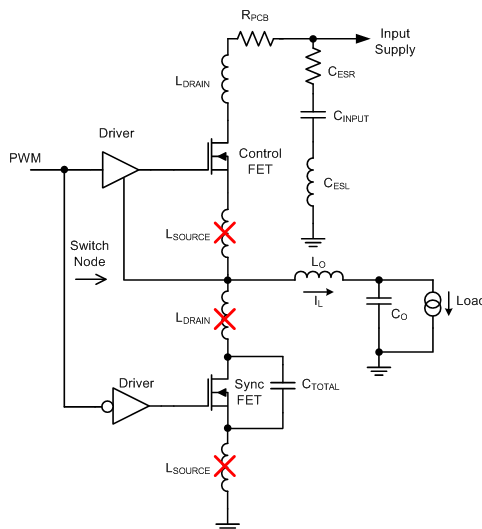

**Figure 29.**

The combination of TI's latest generation silicon and optimized packaging technology has created a benchmarking solution that outperforms industry standard MOSFET chipsets of similar  $R_{DS(ON)}$  and MOSFET chipsets with lower  $R_{DS(ON)}$ . [Figure 30](#) and [Figure 31](#) compare the efficiency and power loss performance of the CSD86330Q3D versus industry standard MOSFET chipsets commonly used in this type of application. This comparison purely focuses on the efficiency and generated loss of the power semiconductors only. The performance of CSD86330Q3D clearly highlights the importance of considering the Effective AC On-Impedance ( $Z_{DS(ON)}$ ) during the MOSFET selection process of any new design. Simply normalizing to traditional MOSFET  $R_{DS(ON)}$  specifications is not an indicator of the actual in-circuit performance when using TI's Power Block technology.

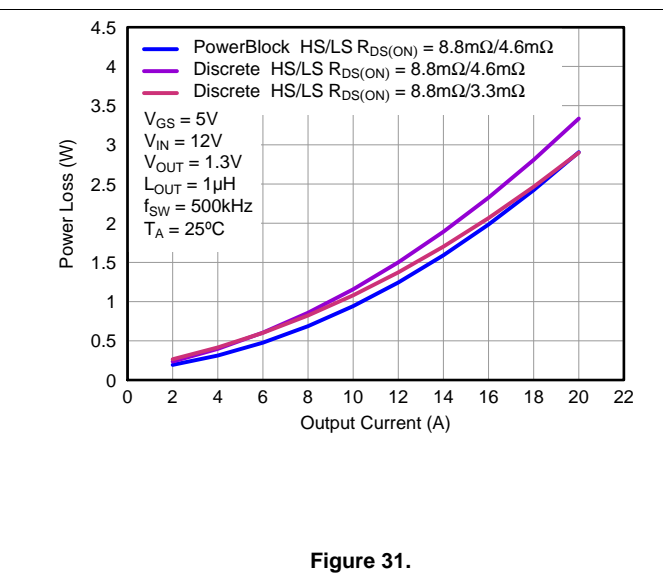
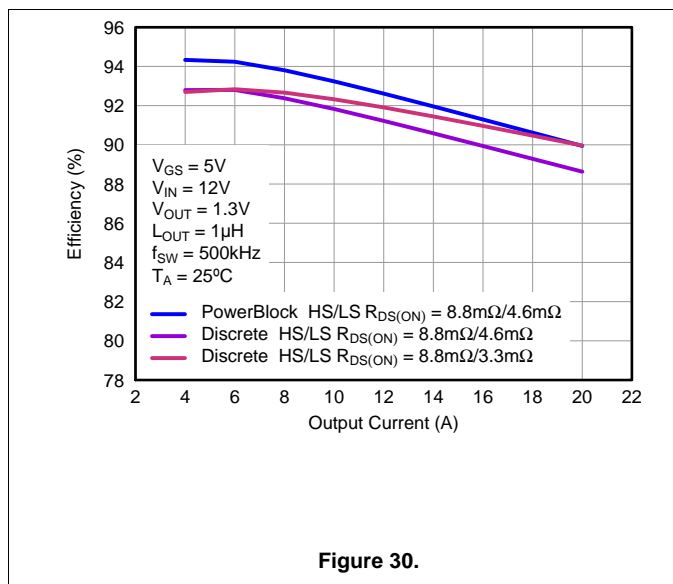

## Application Information (continued)

**Table 1** compares the traditional DC measured  $R_{DS(ON)}$  of CSD86330Q3D versus its  $Z_{DS(ON)}$ . This comparison takes into account the improved efficiency associated with TI's patented packaging technology. As such, when comparing TI's Power Block products to individually packaged discrete MOSFETs or dual MOSFETs in a standard package, the in-circuit switching performance of the solution must be considered. In this example, individually packaged discrete MOSFETs or dual MOSFETs in a standard package would need to have DC measured  $R_{DS(ON)}$  values that are equivalent to CSD86330Q3D's  $Z_{DS(ON)}$  value in order to have the same efficiency performance at full load. Mid to light-load efficiency will still be lower with individually packaged discrete MOSFETs or dual MOSFETs in a standard package.

**Table 1. Comparison of  $R_{DS(ON)}$  vs  $Z_{DS(ON)}$**

Parameter	HS		LS	
	Typ	Max	Typ	Max
Effective AC On-Impedance $Z_{DS(ON)}$ ( $V_{GS} = 5\text{ V}$ )	8.8	-	3.3	-
DC Measured $R_{DS(ON)}$ ( $V_{GS} = 4.5\text{ V}$ )	8.8	11.5	4.6	6

The CSD86330Q3D NexFET power block is an optimized design for synchronous buck applications using 5 V gate drive. The Control FET and Sync FET silicon are parametrically tuned to yield the lowest power loss and highest system efficiency. As a result, a new rating method is needed which is tailored towards a more systems centric environment. System level performance curves such as Power Loss, Safe Operating Area, and normalized graphs allow engineers to predict the product performance in the actual application.

### 6.2 Power Loss Curves

MOSFET centric parameters such as  $R_{DS(ON)}$  and  $Q_{gd}$  are needed to estimate the loss generated by the devices. In an effort to simplify the design process for engineers, Texas Instruments has provided measured power loss performance curves. **Figure 1** plots the power loss of the CSD86330Q3D as a function of load current. This curve is measured by configuring and running the CSD86330Q3D as it would be in the final application (see **Figure 32**). The measured power loss is the CSD86330Q3D loss and consists of both input conversion loss and gate drive loss. **Equation 1** is used to generate the power loss curve.

$$(V_{IN} \times I_{IN}) + (V_{DD} \times I_{DD}) - (V_{SW\_AVG} \times I_{OUT}) = \text{Power Loss} \quad (1)$$

The power loss curve in **Figure 1** is measured at the maximum recommended junction temperatures of 125°C under isothermal test conditions.

### 6.3 Safe Operating Curves (SOA)

The SOA curves in the CSD86330Q3D data sheet provides guidance on the temperature boundaries within an operating system by incorporating the thermal resistance and system power loss. **Figure 3** to **Figure 5** outline the temperature and airflow conditions required for a given load current. The area under the curve dictates the safe operating area. All the curves are based on measurements made on a PCB design with dimensions of 4" (W) × 3.5" (L) × 0.062" (T) and 6 copper layers of 1 oz. copper thickness.

### 6.4 Normalized Curves

The normalized curves in the CSD86330Q3D data sheet provides guidance on the Power Loss and SOA adjustments based on their application specific needs. These curves show how the power loss and SOA boundaries will adjust for a given set of systems conditions. The primary Y-axis is the normalized change in power loss and the secondary Y-axis is the change in system temperature required in order to comply with the SOA curve. The change in power loss is a multiplier for the Power Loss curve and the change in temperature is subtracted from the SOA curve.

**Normalized Curves (continued)**

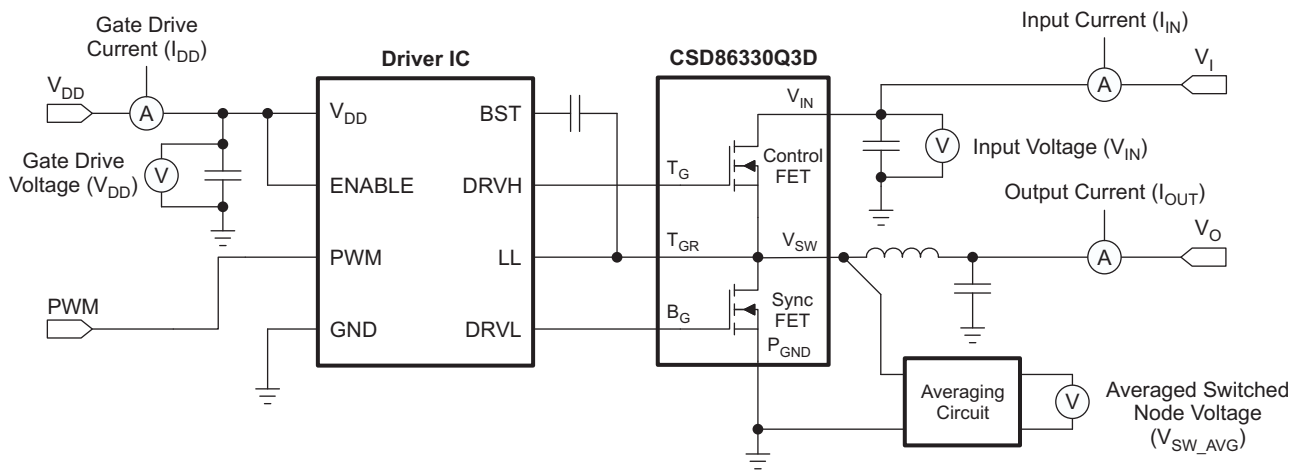

S0475-04

**Figure 32. Typical Application**

## 6.5 Calculating Power Loss and SOA

The user can estimate product loss and SOA boundaries by arithmetic means (see [Design Example](#)). Though the Power Loss and SOA curves in this data sheet are taken for a specific set of test conditions, the following procedure will outline the steps the user should take to predict product performance for any set of system conditions.

### 6.5.1 Design Example

Operating Conditions:

- Output Current = 15 A
- Input Voltage = 12 V
- Output Voltage = 1.2 V
- Switching Frequency = 1000 kHz
- Inductor = 0.4  $\mu$ H

### 6.5.2 Calculating Power Loss

- Power Loss at 15 A = 2.2 W ([Figure 1](#))
- Normalized Power Loss for input voltage  $\approx 1.0$  ([Figure 7](#))
- Normalized Power Loss for output voltage  $\approx 0.98$  ([Figure 8](#))
- Normalized Power Loss for switching frequency  $\approx 1.17$  ([Figure 6](#))
- Normalized Power Loss for output inductor  $\approx 1.06$  ([Figure 9](#))
- **Final calculated Power Loss = 2.2 W  $\times$  1.0  $\times$  0.98  $\times$  1.17  $\times$  1.06  $\approx$  2.67 W**

### 6.5.3 Calculating SOA Adjustments

- SOA adjustment for input voltage  $\approx 0^\circ\text{C}$  ([Figure 7](#))
- SOA adjustment for output voltage  $\approx -0.29^\circ\text{C}$  ([Figure 8](#))
- SOA adjustment for switching frequency  $\approx 4.1^\circ\text{C}$  ([Figure 6](#))
- SOA adjustment for output inductor  $\approx 1.5^\circ\text{C}$  ([Figure 9](#))
- **Final calculated SOA adjustment = 0 + (-0.29) + 4.1 + 1.5  $\approx$  5.3 $^\circ\text{C}$**

In the design example above, the estimated power loss of the CSD86330Q3D would increase to 2.67 W. In addition, the maximum allowable board and/or ambient temperature would have to decrease by 5.3 $^\circ\text{C}$ . [Figure 33](#) graphically shows how the SOA curve would be adjusted accordingly.

1. Start by drawing a horizontal line from the application current to the SOA curve.
2. Draw a vertical line from the SOA curve intercept down to the board/ambient temperature.
3. Adjust the SOA board/ambient temperature by subtracting the temperature adjustment value.

In the design example, the SOA temperature adjustment yields a reduction in allowable board/ambient temperature of 5.3 $^\circ\text{C}$ . In the event the adjustment value is a negative number, subtracting the negative number would yield an increase in allowable board/ambient temperature.

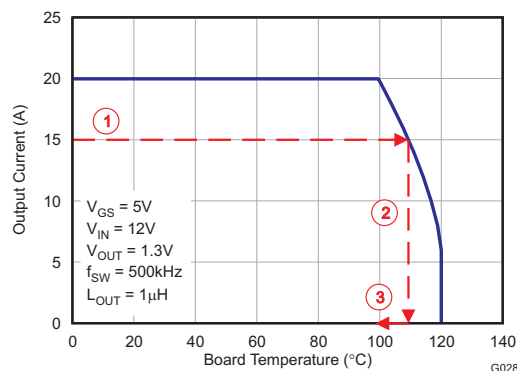

Figure 33. Power Block SOA

## 7 Recommended PCB Design Overview

There are two key system-level parameters that can be addressed with a proper PCB design: Electrical and Thermal performance. Properly optimizing the PCB layout will yield maximum performance in both areas. A brief description on how to address each parameter is provided.

### 7.1 Electrical Performance

The Power Block has the ability to switch voltages at rates greater than 10 kV/μs. Special care must be then taken with the PCB layout design and placement of the input capacitors, Driver IC, and output inductor.

- The placement of the input capacitors relative to the Power Block's VIN and PGND pins should have the highest priority during the component placement routine. It is critical to minimize these node lengths. As such, ceramic input capacitors need to be placed as close as possible to the VIN and PGND pins (see [Figure 34](#)). The example in [Figure 34](#) uses 6 × 10 μF ceramic capacitors (TDK part number C3216X5R1C106KT or equivalent). Notice there are ceramic capacitors on both sides of the board with an appropriate amount of vias interconnecting both layers. In terms of priority of placement next to the Power Block, C5, C7, C19, and C8 should follow in order.
- The Driver IC should be placed relatively close to the Power Block Gate pins. T<sub>G</sub> and B<sub>G</sub> should connect to the outputs of the Driver IC. The T<sub>GR</sub> pin serves as the return path of the high-side gate drive circuitry and should be connected to the Phase pin of the IC (sometimes called LX, LL, SW, PH, etc.). The bootstrap capacitor for the Driver IC will also connect to this pin.
- The switching node of the output inductor should be placed relatively close to the Power Block VSW pins. Minimizing the node length between these two components will reduce the PCB conduction losses and actually reduce the switching noise level.
- In the event the switch node waveform exhibits ringing that reaches undesirable levels, the use of a Boost Resistor or RC snubber can be an effective way to reduce the peak ring level. The recommended Boost Resistor value will range between 1 Ω to 4.7 Ω depending on the output characteristics of Driver IC used in conjunction with the Power Block. The RC snubber values can range from 0.5 Ω to 2.2 Ω for the R and 330 pF to 2200 pF for the C. Refer to TI App Note [SLUP100](#) for more details on how to properly tune the RC snubber values. The RC snubber should be placed as close as possible to the Vsw node and PGND see [Figure 34](#) <sup>(1)</sup>

### 7.2 Thermal Performance

The Power Block has the ability to utilize the GND planes as the primary thermal path. As such, the use of thermal vias is an effective way to pull away heat from the device and into the system board. Concerns of solder voids and manufacturability problems can be addressed by the use of three basic tactics to minimize the amount of solder attach that will wick down the via barrel:

- Intentionally space out the vias from each other to avoid a cluster of holes in a given area.
- Use the smallest drill size allowed in your design. The example in [Figure 34](#) uses vias with a 10 mil drill hole and a 16 mil capture pad.
- Tent the opposite side of the via with solder-mask.

In the end, the number and drill size of the thermal vias should align with the end user's PCB design rules and manufacturing capabilities.

(1) Keong W. Kam, David Pommerenke, "EMI Analysis Methods for Synchronous Buck Converter EMI Root Cause Analysis", University of Missouri – Rolla

Thermal Performance (continued)

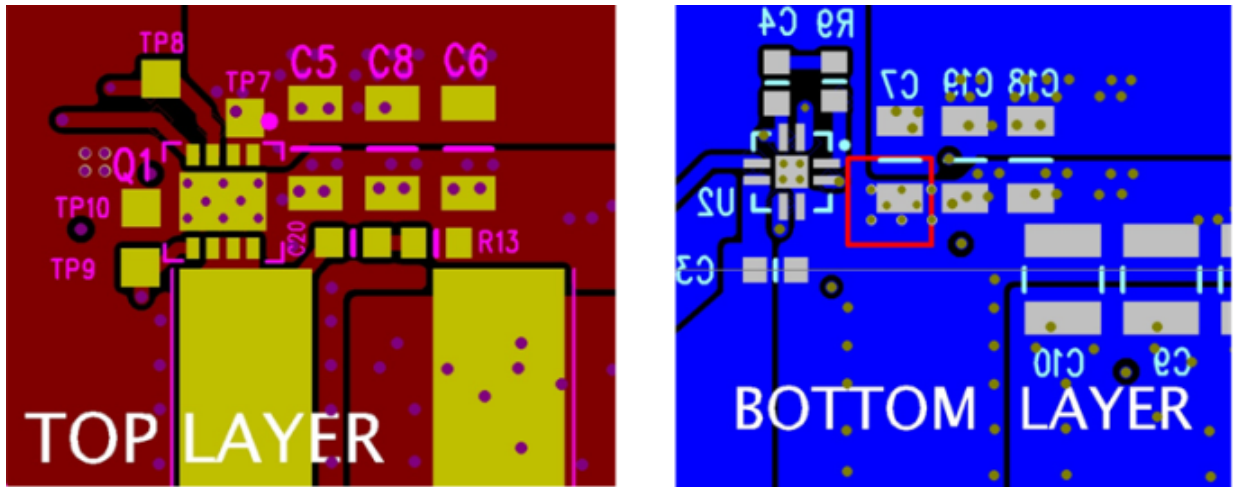

Figure 34. Recommended PCB Layout (Top Down)



## 8 Device and Documentation Support

### 8.1 Trademarks

NexFET is a trademark of Texas Instruments.  
All other trademarks are the property of their respective owners.

### 8.2 Electrostatic Discharge Caution



These devices have limited built-in ESD protection. The leads should be shorted together or the device placed in conductive foam during storage or handling to prevent electrostatic damage to the MOS gates.

### 8.3 Glossary

[SLYZ022](#) — *TI Glossary*.

This glossary lists and explains terms, acronyms, and definitions.

## 9 Mechanical, Packaging, and Orderable Information

### 9.1 Q3D Package Dimensions

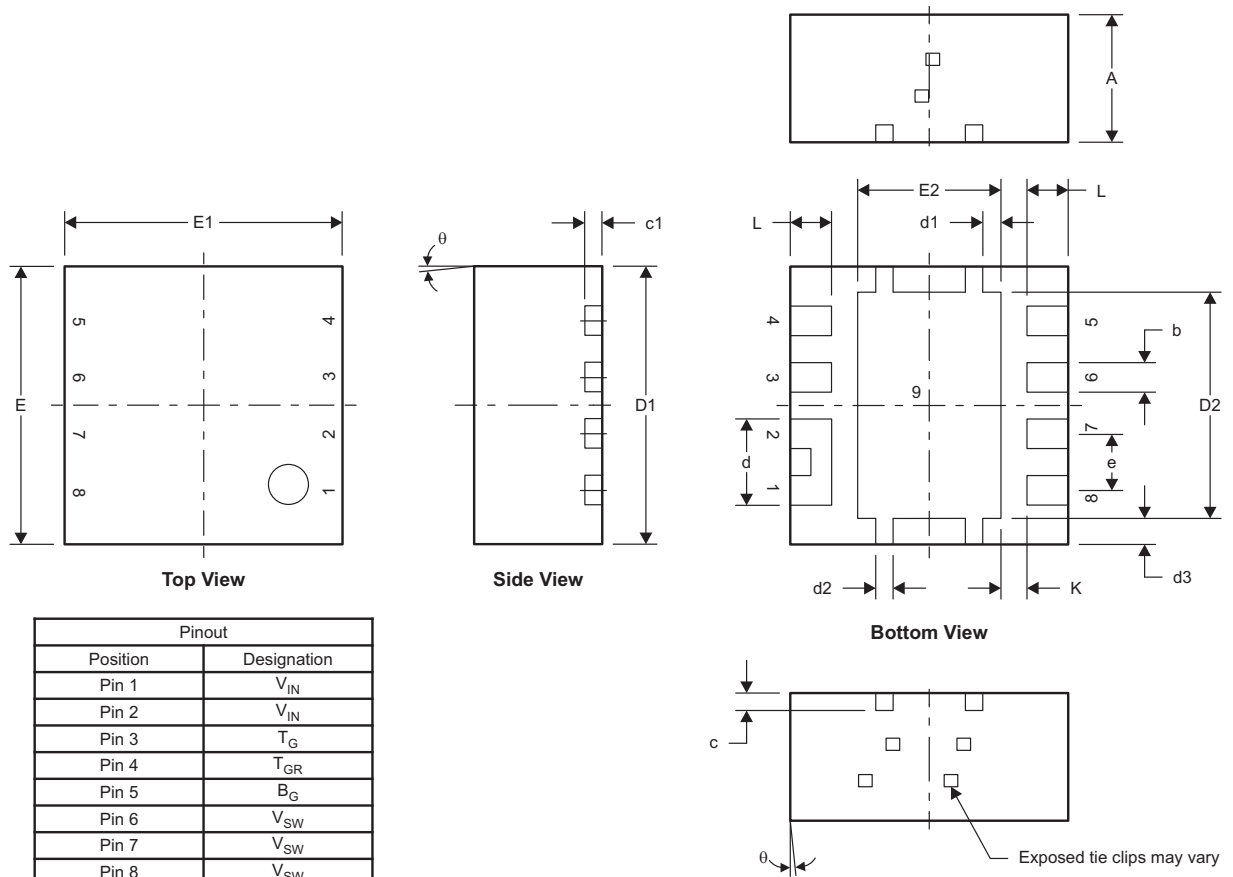

M0192-01

DIM	MILLIMETERS		INCHES	
	MIN	MAX	MIN	MAX
A	1.40	1.5	0.055	0.059
b	0.280	0.400	0.011	0.016
c	0.150	0.250	0.006	0.010
c1	0.150	0.250	0.006	0.010
d	0.940	1.040	0.037	0.041
d1	0.160	0.260	0.006	0.010
d2	0.150	0.250	0.006	0.010
d3	0.250	0.350	0.010	0.014
D1	3.200	3.400	0.126	0.134
D2	2.650	2.750	0.104	0.108
E	3.200	3.400	0.126	0.134
E1	3.200	3.400	0.126	0.134
E2	1.750	1.850	0.069	0.073
e	0.650 TYP		0.026 TYP	
L	0.400	0.500	0.016	0.020
θ	0.00	—	—	—
K	0.300 TYP		0.012 TYP	

## 9.2 Land Pattern Recommendation

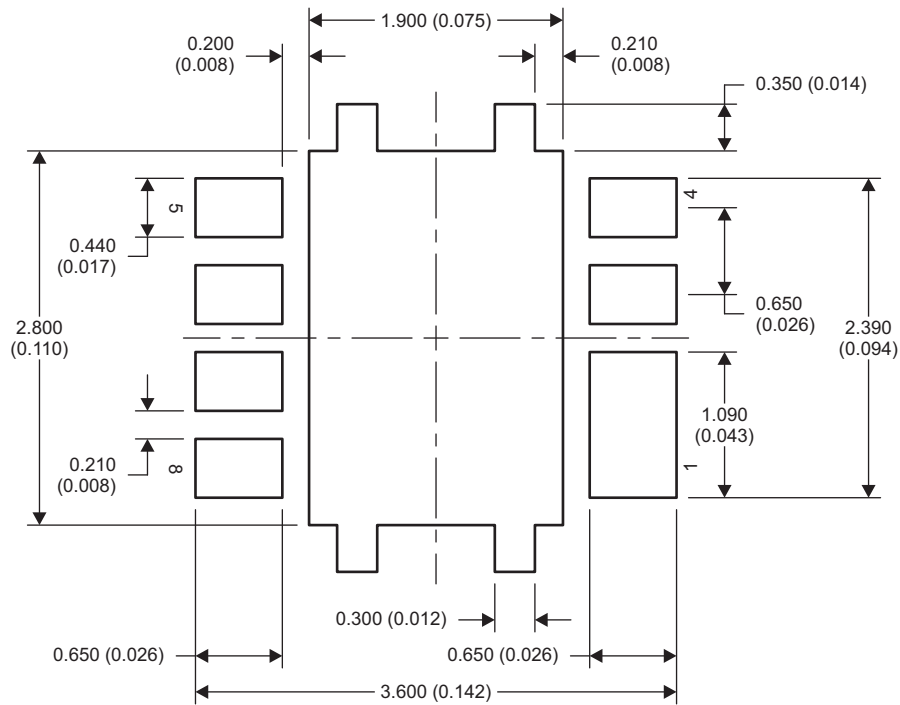

M0193-01

NOTE: Dimensions are in mm (inches).

## 9.3 Stencil Recommendation

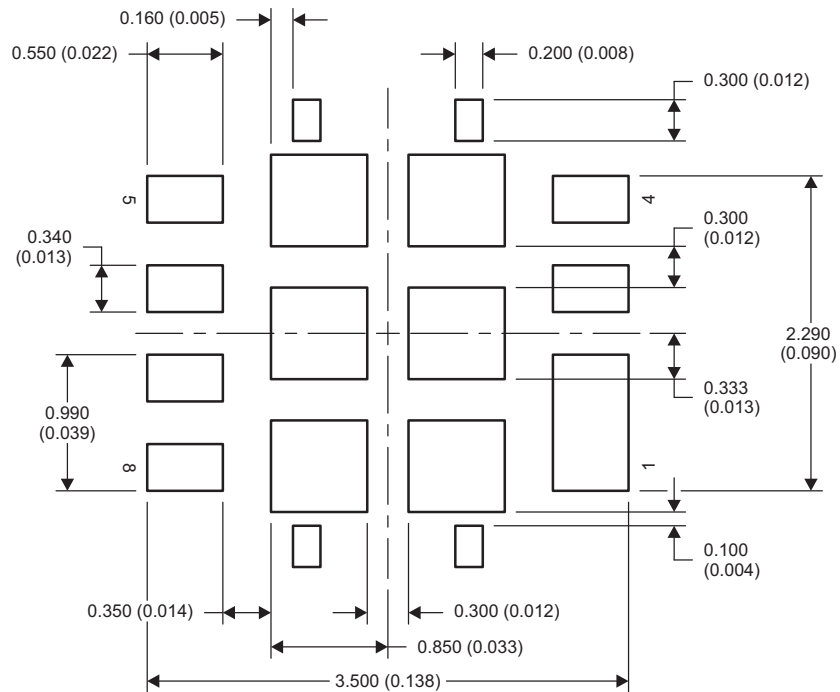

M0207-01

NOTE: Dimensions are in mm (inches).

For recommended circuit layout for PCB designs, see application note [SLPA005 – Reducing Ringing Through PCB Layout Techniques](#).

## 9.4 Q3D Tape and Reel Information

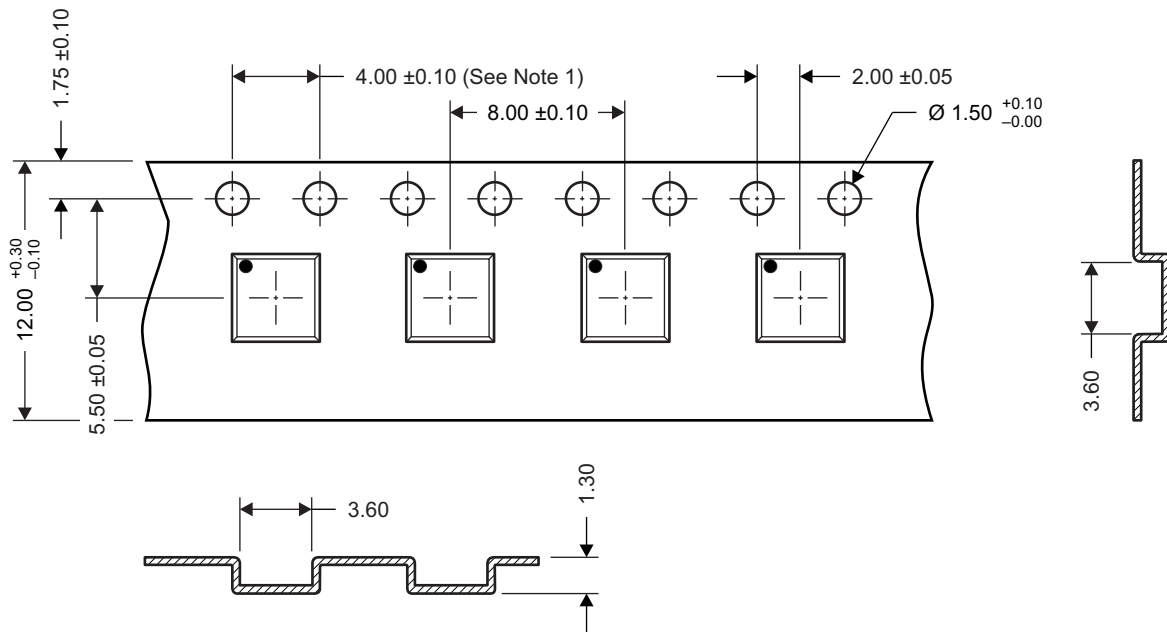

M0144-01

- NOTES:
- 10-sprocket hole-pitch cumulative tolerance  $\pm 0.2$
  - Camber not to exceed 1 mm in 100 mm, noncumulative over 250 mm
  - Material: black static-dissipative polystyrene
  - All dimensions are in mm, unless otherwise specified.
  - Thickness:  $0.30 \pm 0.05$  mm
  - MSL1 260°C (IR and convection) PbF reflow compatible

**TAPE AND REEL INFORMATION**

**QUADRANT ASSIGNMENTS FOR PIN 1 ORIENTATION IN TAPE**

\*All dimensions are nominal

Device	Package Type	Package Drawing	Pins	SPQ	Reel Diameter (mm)	Reel Width W1 (mm)	A0 (mm)	B0 (mm)	K0 (mm)	P1 (mm)	W (mm)	Pin1 Quadrant
CSD86330Q3D	LSON-CLIP	DQZ	8	2500	330.0	12.4	3.55	3.55	1.7	8.0	12.0	Q1
CSD86330Q3D	LSON-CLIP	DQZ	8	2500	330.0	15.4	3.6	3.6	1.7	8.0	12.0	Q1

**TAPE AND REEL BOX DIMENSIONS**



\*All dimensions are nominal

Device	Package Type	Package Drawing	Pins	SPQ	Length (mm)	Width (mm)	Height (mm)
CSD86330Q3D	LSON-CLIP	DQZ	8	2500	367.0	367.0	35.0
CSD86330Q3D	LSON-CLIP	DQZ	8	2500	335.0	335.0	32.0

## IMPORTANT NOTICE

Texas Instruments Incorporated (TI) reserves the right to make corrections, enhancements, improvements and other changes to its semiconductor products and services per JESD46, latest issue, and to discontinue any product or service per JESD48, latest issue. Buyers should obtain the latest relevant information before placing orders and should verify that such information is current and complete.

TI's published terms of sale for semiconductor products (<http://www.ti.com/sc/docs/stdterms.htm>) apply to the sale of packaged integrated circuit products that TI has qualified and released to market. Additional terms may apply to the use or sale of other types of TI products and services.

Reproduction of significant portions of TI information in TI data sheets is permissible only if reproduction is without alteration and is accompanied by all associated warranties, conditions, limitations, and notices. TI is not responsible or liable for such reproduced documentation. Information of third parties may be subject to additional restrictions. Resale of TI products or services with statements different from or beyond the parameters stated by TI for that product or service voids all express and any implied warranties for the associated TI product or service and is an unfair and deceptive business practice. TI is not responsible or liable for any such statements.

Buyers and others who are developing systems that incorporate TI products (collectively, "Designers") understand and agree that Designers remain responsible for using their independent analysis, evaluation and judgment in designing their applications and that Designers have full and exclusive responsibility to assure the safety of Designers' applications and compliance of their applications (and of all TI products used in or for Designers' applications) with all applicable regulations, laws and other applicable requirements. Designer represents that, with respect to their applications, Designer has all the necessary expertise to create and implement safeguards that (1) anticipate dangerous consequences of failures, (2) monitor failures and their consequences, and (3) lessen the likelihood of failures that might cause harm and take appropriate actions. Designer agrees that prior to using or distributing any applications that include TI products, Designer will thoroughly test such applications and the functionality of such TI products as used in such applications.

TI's provision of technical, application or other design advice, quality characterization, reliability data or other services or information, including, but not limited to, reference designs and materials relating to evaluation modules, (collectively, "TI Resources") are intended to assist designers who are developing applications that incorporate TI products; by downloading, accessing or using TI Resources in any way, Designer (individually or, if Designer is acting on behalf of a company, Designer's company) agrees to use any particular TI Resource solely for this purpose and subject to the terms of this Notice.

TI's provision of TI Resources does not expand or otherwise alter TI's applicable published warranties or warranty disclaimers for TI products, and no additional obligations or liabilities arise from TI providing such TI Resources. TI reserves the right to make corrections, enhancements, improvements and other changes to its TI Resources. TI has not conducted any testing other than that specifically described in the published documentation for a particular TI Resource.

Designer is authorized to use, copy and modify any individual TI Resource only in connection with the development of applications that include the TI product(s) identified in such TI Resource. NO OTHER LICENSE, EXPRESS OR IMPLIED, BY ESTOPPEL OR OTHERWISE TO ANY OTHER TI INTELLECTUAL PROPERTY RIGHT, AND NO LICENSE TO ANY TECHNOLOGY OR INTELLECTUAL PROPERTY RIGHT OF TI OR ANY THIRD PARTY IS GRANTED HEREIN, including but not limited to any patent right, copyright, mask work right, or other intellectual property right relating to any combination, machine, or process in which TI products or services are used. Information regarding or referencing third-party products or services does not constitute a license to use such products or services, or a warranty or endorsement thereof. Use of TI Resources may require a license from a third party under the patents or other intellectual property of the third party, or a license from TI under the patents or other intellectual property of TI.

TI RESOURCES ARE PROVIDED "AS IS" AND WITH ALL FAULTS. TI DISCLAIMS ALL OTHER WARRANTIES OR REPRESENTATIONS, EXPRESS OR IMPLIED, REGARDING RESOURCES OR USE THEREOF, INCLUDING BUT NOT LIMITED TO ACCURACY OR COMPLETENESS, TITLE, ANY EPIDEMIC FAILURE WARRANTY AND ANY IMPLIED WARRANTIES OF MERCHANTABILITY, FITNESS FOR A PARTICULAR PURPOSE, AND NON-INFRINGEMENT OF ANY THIRD PARTY INTELLECTUAL PROPERTY RIGHTS. TI SHALL NOT BE LIABLE FOR AND SHALL NOT DEFEND OR INDEMNIFY DESIGNER AGAINST ANY CLAIM, INCLUDING BUT NOT LIMITED TO ANY INFRINGEMENT CLAIM THAT RELATES TO OR IS BASED ON ANY COMBINATION OF PRODUCTS EVEN IF DESCRIBED IN TI RESOURCES OR OTHERWISE. IN NO EVENT SHALL TI BE LIABLE FOR ANY ACTUAL, DIRECT, SPECIAL, COLLATERAL, INDIRECT, PUNITIVE, INCIDENTAL, CONSEQUENTIAL OR EXEMPLARY DAMAGES IN CONNECTION WITH OR ARISING OUT OF TI RESOURCES OR USE THEREOF, AND REGARDLESS OF WHETHER TI HAS BEEN ADVISED OF THE POSSIBILITY OF SUCH DAMAGES.

Unless TI has explicitly designated an individual product as meeting the requirements of a particular industry standard (e.g., ISO/TS 16949 and ISO 26262), TI is not responsible for any failure to meet such industry standard requirements.

Where TI specifically promotes products as facilitating functional safety or as compliant with industry functional safety standards, such products are intended to help enable customers to design and create their own applications that meet applicable functional safety standards and requirements. Using products in an application does not by itself establish any safety features in the application. Designers must ensure compliance with safety-related requirements and standards applicable to their applications. Designer may not use any TI products in life-critical medical equipment unless authorized officers of the parties have executed a special contract specifically governing such use. Life-critical medical equipment is medical equipment where failure of such equipment would cause serious bodily injury or death (e.g., life support, pacemakers, defibrillators, heart pumps, neurostimulators, and implantables). Such equipment includes, without limitation, all medical devices identified by the U.S. Food and Drug Administration as Class III devices and equivalent classifications outside the U.S.

TI may expressly designate certain products as completing a particular qualification (e.g., Q100, Military Grade, or Enhanced Product). Designers agree that it has the necessary expertise to select the product with the appropriate qualification designation for their applications and that proper product selection is at Designers' own risk. Designers are solely responsible for compliance with all legal and regulatory requirements in connection with such selection.

Designer will fully indemnify TI and its representatives against any damages, costs, losses, and/or liabilities arising out of Designer's non-compliance with the terms and provisions of this Notice.