

TOSHIBA Bipolar Linear Integrated Circuit Silicon Monolithic

TA8208H

5.8W Dual Audio Power Amplifier

The TA8208H are dual audio power amplifier for consumer applications.

It is designed for high power, low distortion and low noise.

It also contains various kind of protectors.

It is suitable for car-audio power amplifier with high performance.

$P_{OUT} = 5.8W$ (typ.) / ch
($V_{CC} = 13.2V$, $f = 1kHz$, $THD = 10\%$, $R_L = 4\Omega$)

Features

- Low distortion
 - : $THD = 0.06\%$ (typ.)
 - ($V_{CC} = 13.2V$, $f = 1kHz$, $P_{OUT} = 1W$, $R_L = 4\Omega$, $GV = 52dB$)
- Low noise
 - : $V_{NO} = 0.7mV_{rms}$ (typ.)
 - ($V_{CC} = 13.2V$, $R_L = 4\Omega$, $GV = 52dB$, $R_g = 10k\Omega$, $BW = 20Hz \sim 20kHz$)
- Protector circuit
 - : Thermal shut down, over voltage protection.
 - Out- V_{CC} short, Out- GND short and Out-Out short protection.
- Operation supply voltage range
 - : $V_{CC(opr.)} = 9 \sim 18V$

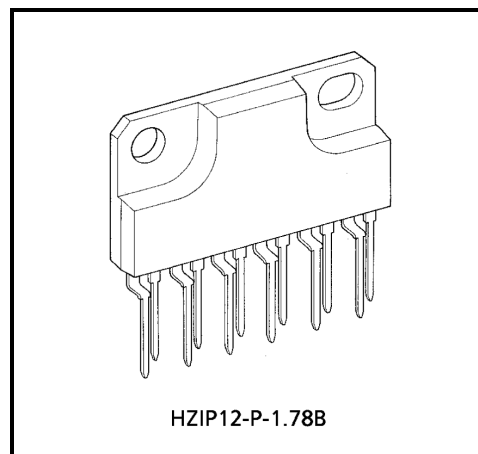

Weight: 4.04g (typ.)

Block Diagram

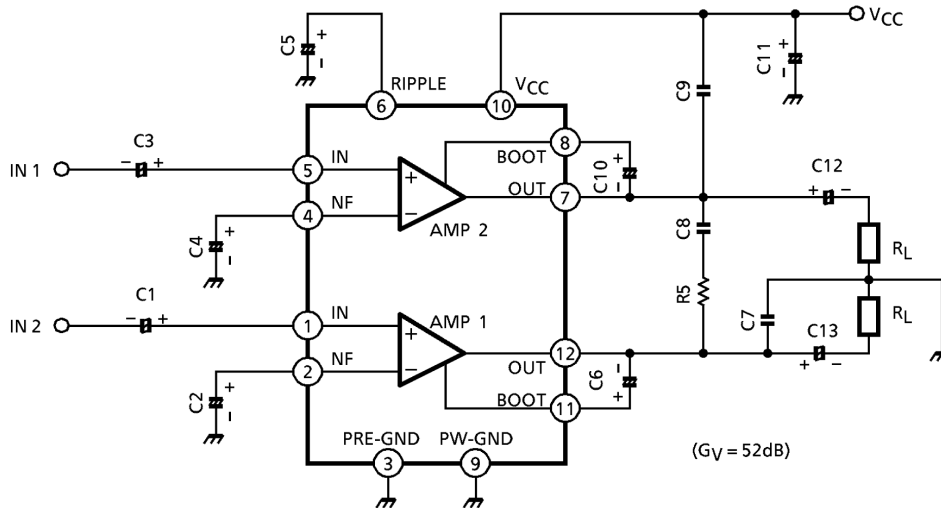

Caution And Application Method

1. Voltage gain adjustment

The voltage gain G_V is determined by R_1 , R_2 and R_f in Fig.1.

$$G_V = 20 \log \frac{R_f + R_1 + R_2}{R_f + R_1} \text{ (dB)}$$

In case of $R_f = 0$

The voltage gain is set as follows:

$$G_V = 52 \text{ dB (typ.)}$$

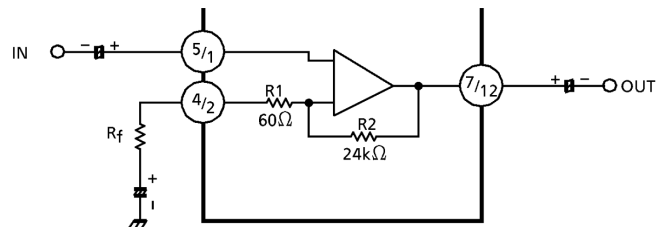

Fig.1

2. Muting

Audio muting can be accomplished by connecting pin (6) (ripple filter) to GND as shown in Fig.2.

Then, the bias circuits are cut off.

However, caution must be exercised to the following items.

- (1) The recovery time from the muting operation is determined by the capacities of the ripple filter capacitor between (6) pin and GND, and of the capacitor for NF.
- (2) As this muting system is operated by the short-circuit of ripple filter: C5, the ripple rejection ratio becomes worse in the muting condition.

At mute on, some pop noises of breaking the bias are produced.

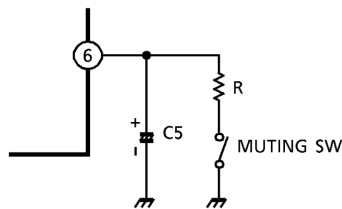

Fig.2

3. Measures against oscillation

C7, C8, C9: The capacitor of polyester film having small variation of the temperature characteristics is recommended as the capacitor for oscillation prevention.

R5: Increases the oscillation allowance at output clipping of the low range frequency (100Hz or less).

Since the oscillation allowance varies according of the following items, carry out the temperature test to confirm the oscillation allowance.

- (1) Gain to be used (GV setting)
- (2) Capacity of capacitor
- (3) Kinds of capacitor
- (4) Layout of printed board

It is recommended to use the capacitor having the capacity exceeding the oscillation stopping value.

At using with the voltage gain GV lowered or with the high range frequency and the oscillation becomes liable to be produced.

Therefore, application with GV = 40dB or over is advisable.

Especially for using with the gain lowered in dual operation, insert 1000pF between NF (2 pin and 4 pin) and GND.

This capacitor reduces the gain of the high range frequency and is effective for oscillation prevention.

4. Output waveform at power supply on / off (reference)

Amplifier DC output waveforms in the condition of $V_{CC} = 13.2V$, $R_L = 4\Omega$ at non-signal (input short) are shown in Fig.3.

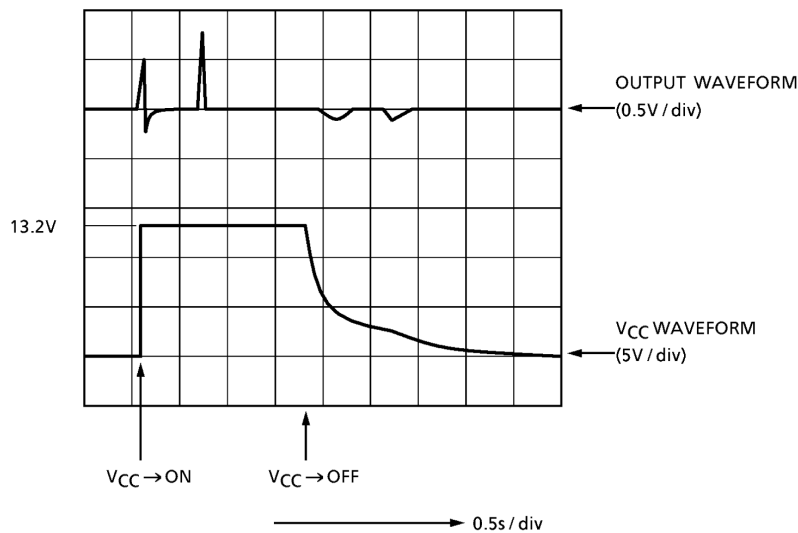

Fig.3

The popping time at power supply on / off varies according to the rise and fall times.

The condition in which the power supply is rapidly and repeatedly made on / off, that is, the condition in which the charge is made on the external capacitor of IC is different from the conditions shown in Fig.3.

Maximum Ratings (Ta = 25°C)

Characteristic	Symbol	Rating	Unit
Peak supply voltage (0.2s)	V _{CC} (surge)	45	V
DC supply voltage	V _{CC} (DC)	25	V
Operating supply voltage	V _{CC} (opr)	18	V
Output current (peak)	I _O (peak)	4.5	A
Power dissipation	P _D	25	W
Operating temperature	T _{opr}	-30~85	°C
Storage temperature	T _{stg}	-55~150	°C

Electrical Characteristics

(unless otherwise specified, V_{CC} = 13.2V, R_L = 4Ω, R_g = 600Ω, f = 1kHz, Ta = 25°C)

Characteristic	Symbol	Test Circuit	Test Condition	Min.	Typ.	Max.	Unit
Quiescent current	I _{CCQ}	—	V _{IN} = 0	—	80	145	mA
Output power	P _{OUT}	—	THD = 10%	5	5.8	—	W
Total harmonic distortion	THD	—	P _{OUT} = 1W	—	0.06	0.30	%
Voltage gain	G _V	—	V _{OUT} = 0.775V _{rms} (0dBm)	50	52	54	dB
Voltage gain ratio	ΔG _V	—	V _{OUT} = 0.775V _{rms} (0dBm)	-1	0	1	dB
Output noise voltage	V _{NO}	—	R _g = 10kΩ BW = 20Hz~20kHz	—	0.7	1.5	mV _{rms}
Ripple rejection ratio	R.R.	—	f _{ripple} = 100Hz V _{ripple} = 0.775V _{rms} (0dBm)	—	-52	-40	dB
Cross talk	C.T.	—	V _{OUT} = 0.775V _{rms} (0dBm)	—	-57	—	dB
Input resistance	R _{IN}	—	f = 1kHz	—	33	—	kΩ

Typical DC Voltage Of Each Terminal

(V_{CC} = 13.2V, V_{IN} = 0V, Ta = 25°C)

Terminal no.	1	2	3	4	5	6	7	8	9	10	11	12
DC voltage (V)	1.5	1.5	GND	1.5	1.5	6.4	6.4	12.3	GND	V _{CC}	12.3	6.4

Test Circuit / Application Circuit

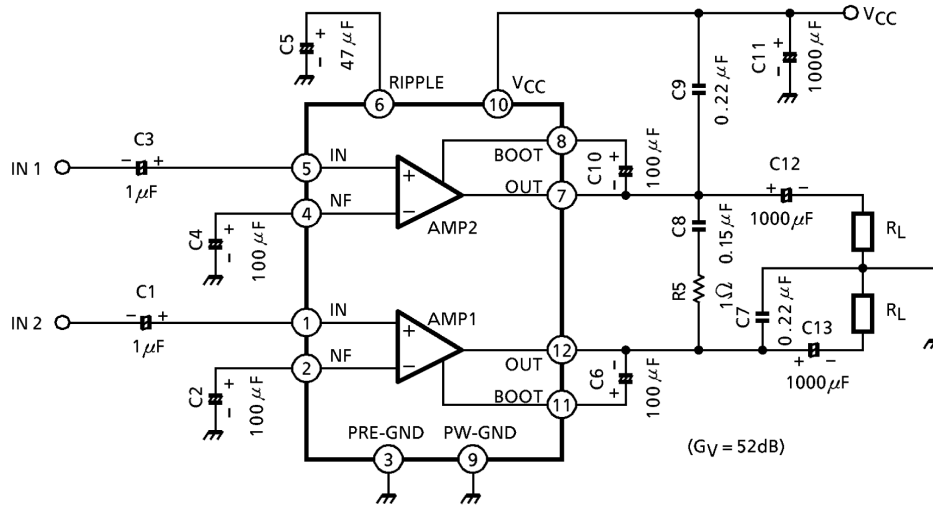

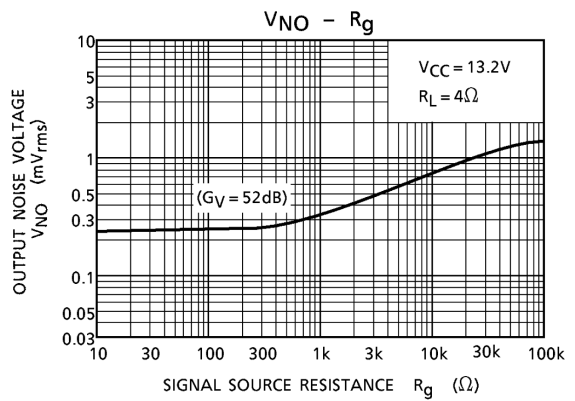
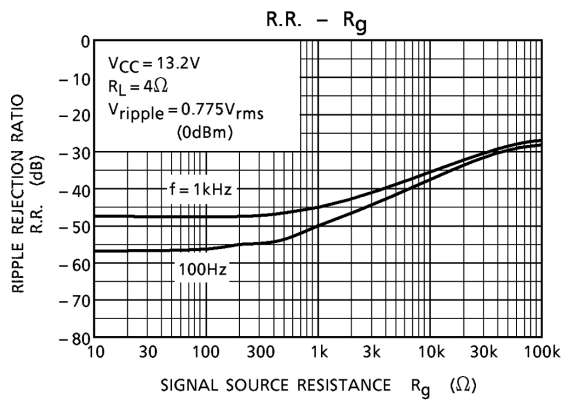
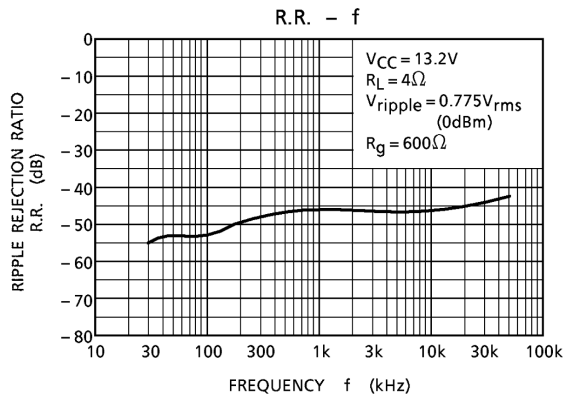
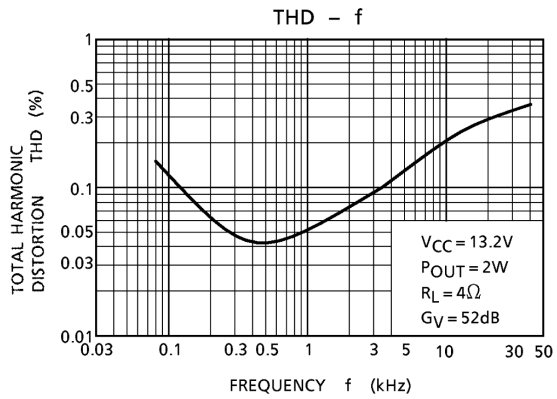
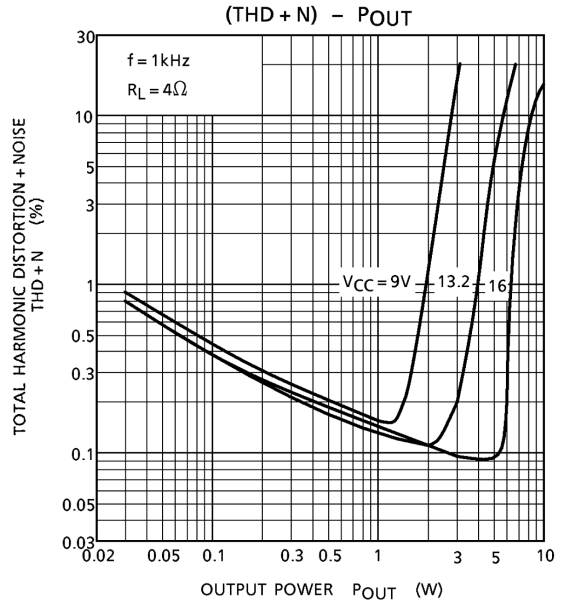
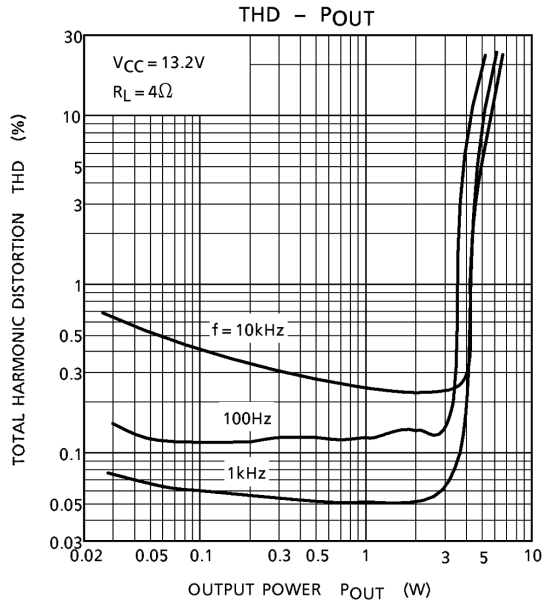

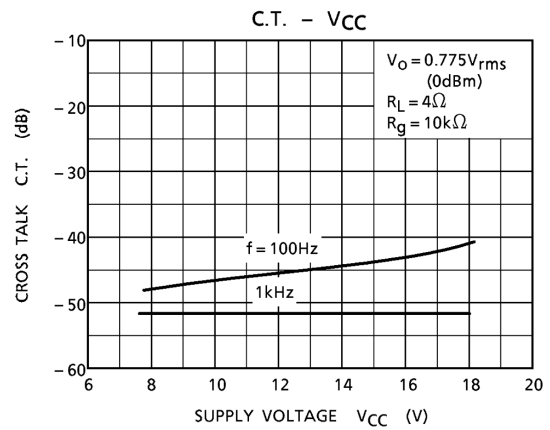
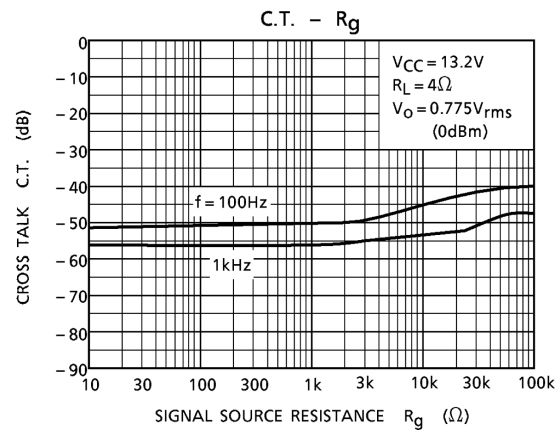
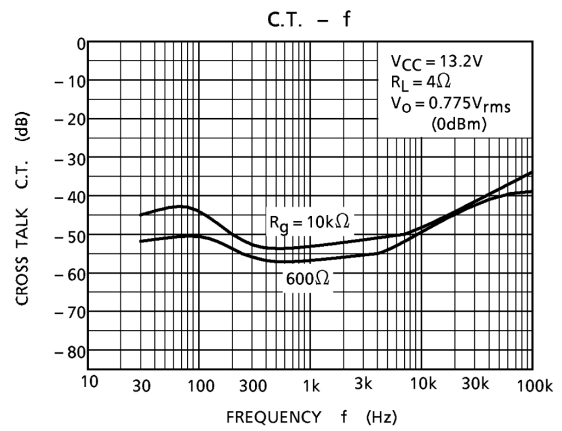
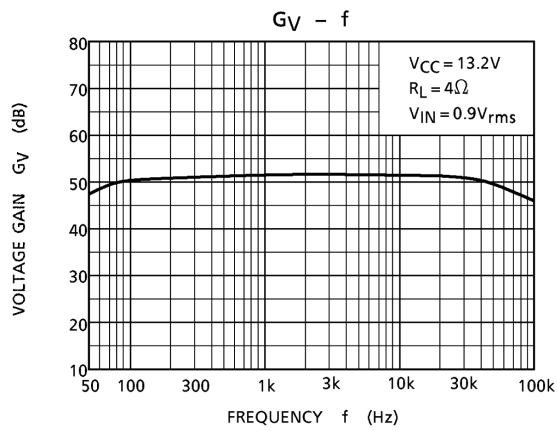
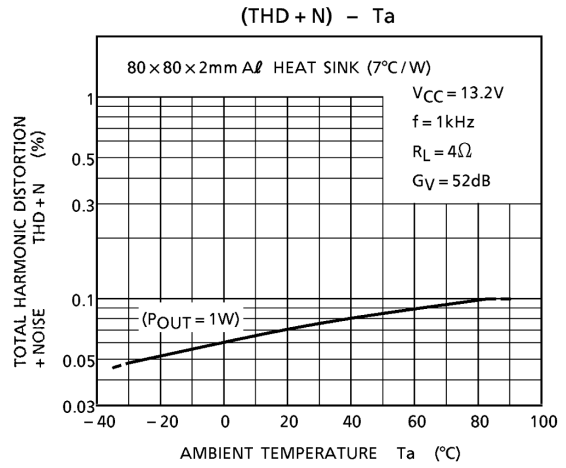
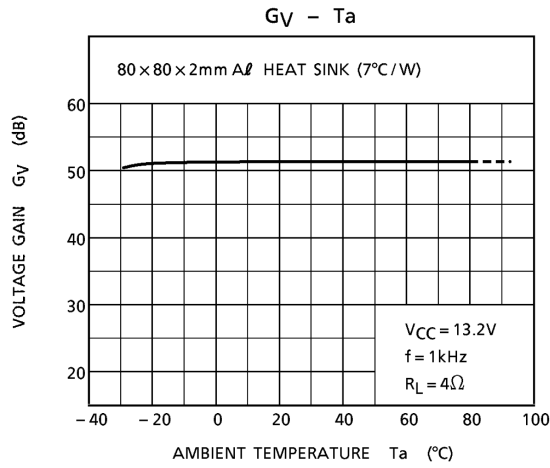

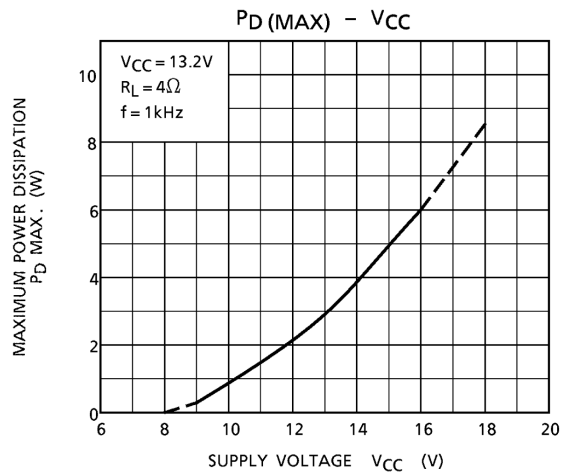
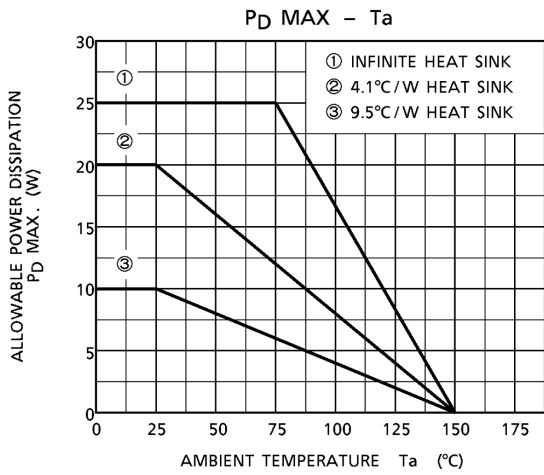
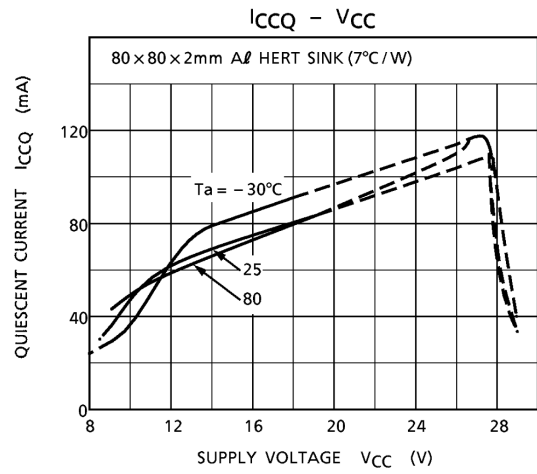
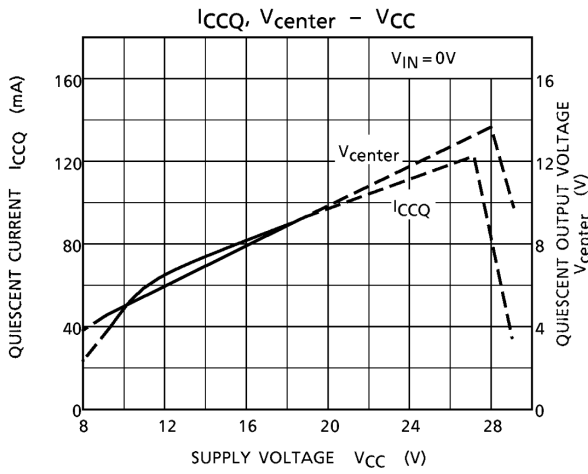
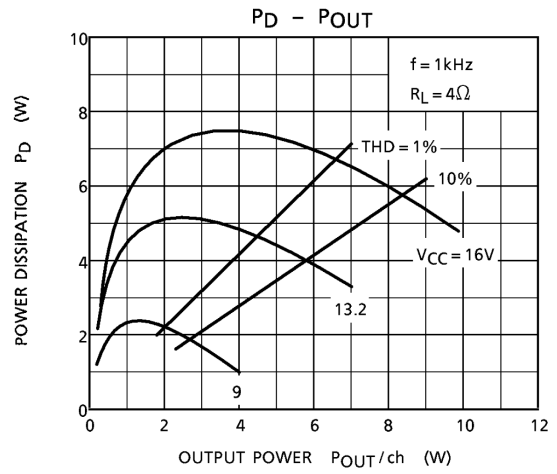
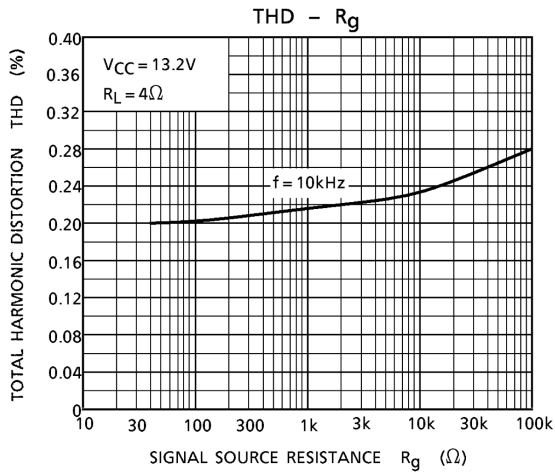

Package Dimensions

HZIP12-P-1.78B

Unit : mm

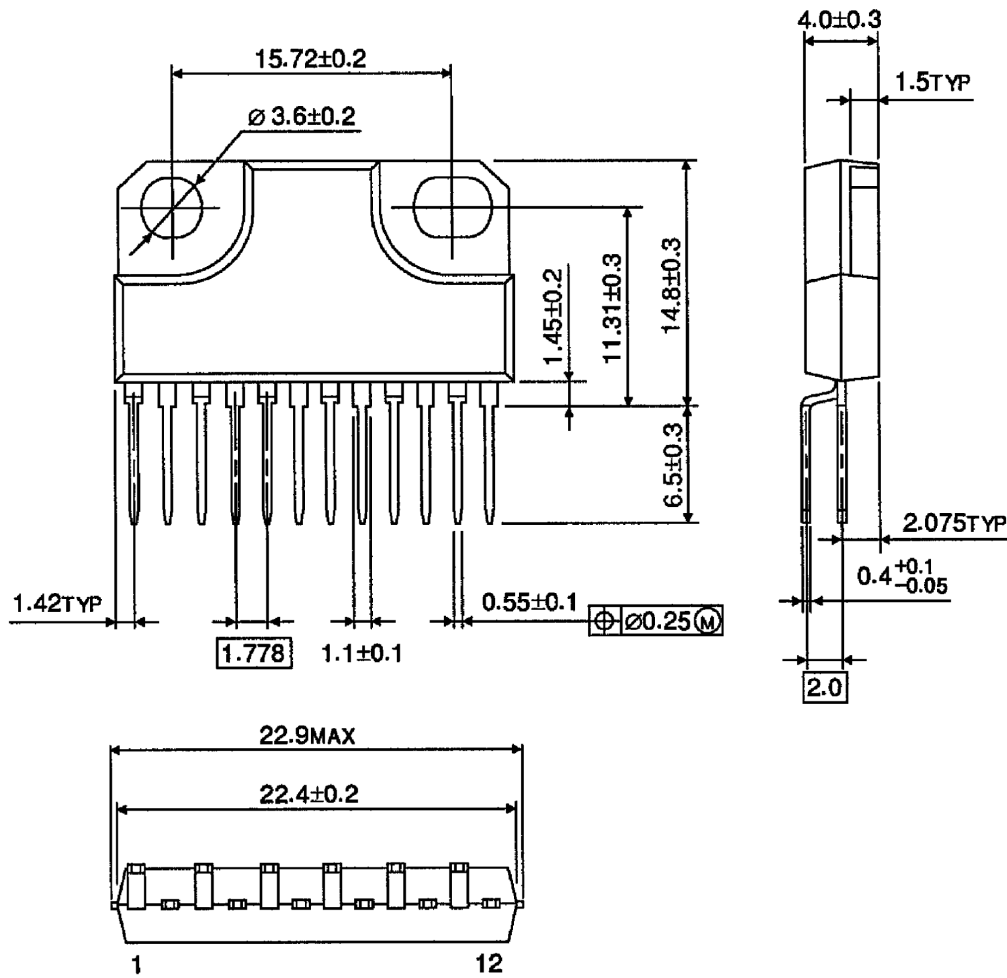

Weight: 4.04g (typ.)

RESTRICTIONS ON PRODUCT USE

000707EBF

- TOSHIBA is continually working to improve the quality and reliability of its products. Nevertheless, semiconductor devices in general can malfunction or fail due to their inherent electrical sensitivity and vulnerability to physical stress. It is the responsibility of the buyer, when utilizing TOSHIBA products, to comply with the standards of safety in making a safe design for the entire system, and to avoid situations in which a malfunction or failure of such TOSHIBA products could cause loss of human life, bodily injury or damage to property.
In developing your designs, please ensure that TOSHIBA products are used within specified operating ranges as set forth in the most recent TOSHIBA products specifications. Also, please keep in mind the precautions and conditions set forth in the "Handling Guide for Semiconductor Devices," or "TOSHIBA Semiconductor Reliability Handbook" etc..
- The TOSHIBA products listed in this document are intended for usage in general electronics applications (computer, personal equipment, office equipment, measuring equipment, industrial robotics, domestic appliances, etc.). These TOSHIBA products are neither intended nor warranted for usage in equipment that requires extraordinarily high quality and/or reliability or a malfunction or failure of which may cause loss of human life or bodily injury ("Unintended Usage"). Unintended Usage include atomic energy control instruments, airplane or spaceship instruments, transportation instruments, traffic signal instruments, combustion control instruments, medical instruments, all types of safety devices, etc.. Unintended Usage of TOSHIBA products listed in this document shall be made at the customer's own risk.
- This product generates heat during normal operation. However, substandard performance or malfunction may cause the product and its peripherals to reach abnormally high temperatures.
The product is often the final stage (the external output stage) of a circuit. Substandard performance or malfunction of the destination device to which the circuit supplies output may cause damage to the circuit or to the product.
- The products described in this document are subject to the foreign exchange and foreign trade laws.
- The information contained herein is presented only as a guide for the applications of our products. No responsibility is assumed by TOSHIBA CORPORATION for any infringements of intellectual property or other rights of the third parties which may result from its use. No license is granted by implication or otherwise under any intellectual property or other rights of TOSHIBA CORPORATION or others.
- The information contained herein is subject to change without notice.